



USB3 VISION CAMERAS

Alvium USB Cameras User Guide

V5.1.0

Latest FW: 00.14.01.d83c7207

Note: Lenses are not part of this product.

**Quick links**

- [Alvium USB cameras at a glance](#) on page 15
- [Contact us](#) on page 21
- [Contents](#) on page 22

Read before use

EN - English

Safety

Before using the camera, read these safety instructions. Observe the warnings at all times. Use the camera only as stated in the [Intended use](#) on page 62.

**WARNING**

This product can expose you to chemicals including Lead and Lead Compounds, which is known to the State of California to cause cancer and birth defects or other reproductive harm. For more information go to: www.P65Warnings.ca.gov.

**CAUTION****Risk of burns**

A camera in operation can reach temperature levels which could cause burns.

**CAUTION****Injury by falling cameras or lenses**

A falling camera or lens can cause injury.

**CAUTION****Risk of cuts by sharp edges**

The product can have sharp edges.

Intended use

Intended use of Allied Vision product is the integration into vision systems by professionals. All Allied Vision product is sold in a B2B setting.

Cameras without closed housings

Cameras without housing or with incomplete housing must be shielded against EMC emission by professionals according to local EMC provisions.

DA - Dansk

Sikkerhed

Læs sikkerhedsanvisningerne, før kameraet bruges. Overhold alle advarsler. Brug kun kameraet som anført i [Intended use](#) på side 62.



FORSIGTIG

Forbrændingsfare

Når kameraet bruges, kan det blive meget varmt og forårsage forbrændinger.



FORSIGTIG

Kvæstelser, hvis kameraet eller linser falder ned

Falder kameraet eller linsen ned, kan dette forårsage kvæstelser.



FORSIGTIG

Fare for skarpe kanter

Produktet kan have skarpe kanter.

Tilsluttet brug

Allied Vision produktets tilsluttede brug er en indbygning i et visionssystem, udført af fagfolk. Alle Allied Vision produkter sælges i B2B.

Kameraer uden lukket hus

Kameraer uden hus eller uden komplet hus skal beskyttes mod EMC emissioner iht. lokale EMC bestemmelser.

DE - Deutsch

Sicherheit

Bevor Sie die Kamera benutzen, lesen Sie diese Sicherheitshinweise. Beachten Sie diese Hinweise immer. Verwenden Sie die Kamera nur wie beschrieben in [Intended use](#) auf Seite 62.



VORSICHT

Gefahr von Verbrennungen

Im Betrieb kann die Kamera Temperaturen erreichen, die zu Verbrennungen führen.



VORSICHT

Verletzung durch fallende Kameras oder Objektive

Eine fallende Kamera oder ein fallendes Objektiv kann Verletzungen verursachen.



VORSICHT

Schnitte durch scharfe Kanten

Das Produkt kann scharfe Kanten haben.

Bestimmungsgemäßer Gebrauch

Allied Vision Produkte sind bestimmt für die Integration in Bildverarbeitungssysteme durch Fachpersonal. Alle Allied Vision Produkte werden in einer B2B-Umgebung verkauft.

Kameras ohne geschlossenes Gehäuse

Für Kameras ohne Gehäuse oder mit unvollständigem Gehäuse muss die Abschirmung gegen EMV-Emissionen gemäß den örtlichen EMV-Bestimmungen durchgeführt werden.

ES - Español

Seguridad

Antes de utilizar la cámara lea estas instrucciones de seguridad. Observe las advertencias en todo momento. Utilice la cámara solo tal y como se estipula en el [Intended use](#) en la página 62.



ADVERTENCIA

Este producto puede exponerle a químicos incluyendo plomo y compuestos de plomo, que son conocidos por el Estado de California como causantes de cáncer y defectos de nacimiento u otros daños reproductivos. Para mayor información, visite www.P65Warnings.ca.gov.



ATENCIÓN

Riesgo de quemaduras

Una cámara en funcionamiento puede alcanzar temperaturas que podrían provocar quemaduras.



ATENCIÓN

Lesiones en caso de que las cámaras o las lentes se caigan

Si una cámara o una lente se cae puede provocar lesiones.



ATENCIÓN

Riesgo de cortes por bordes afilados

El producto puede tener bordes afilados.

Uso previsto

El uso previsto del producto Allied Vision es la integración en el sistema de visión por parte de profesionales. Todos los productos Allied Vision se venden dentro de una relación B2B.

Cámaras sin carcasa cerrada

Las cámaras sin carcasa o con una carcasa incompleta deben protegerse contra las emisiones CEM por parte de profesionales de acuerdo con las disposiciones locales sobre la CEM.

FI - Suomi

Turvallisuus

Lue nämä turvallisuusohjeet ennen kameran käyttöä. Noudata varoituksia joka hetki. Käytä kameraa ainoastaan kohdassa [Intended use](#) sivulla 62 kuvatulla tavalla.



HUOMIO

Palovammojen vaara

Käytössä olevan kameran saavuttamat lämpötilatasot voivat aiheuttaa palovammoja.



HUOMIO

Putoavien kameroiden tai linssien aiheuttamat vammat

Putoava kamera tai linssi voi aiheuttaa vammoja.



HUOMIO

Terävien reunojen aiheuttama viiltovaara

Tuotteessa voi olla teräviä reunoja.

Käyttötarkoitus

Allied Vision-tuotteen käyttötarkoitus on integrointi kuvajärjestelmiin ammattilaisten toimesta. Kaikki Allied Vision-tuotteet myydään B2B-ympäristössä.

Kamerat, joissa ei ole suljettuja koteloita

Ammattilaisten on suojattava kamerat, joissa ei ole koteloa tai joiden kotelo on epätäydellinen, EMC-päästöiltä paikallisten EMC-määräysten mukaisesti.

FR - Français

Sécurité

Veillez lire ces consignes de sécurité avant d'utiliser la caméra. Respectez continuellement les avertissements. Utilisez la caméra uniquement comme indiqué sous [Intended use](#), page 62.



ATTENTION

Risque de brûlures

Une caméra en service peut atteindre des niveaux de température susceptibles d'entraîner des brûlures.



ATTENTION

Blessures en cas de chute de caméras ou d'objectifs

La chute d'une caméra ou d'un objectif peut entraîner des blessures.



ATTENTION

Risque de coupures sur des bords tranchants

Le produit peut présenter des bords tranchants.

Utilisation prévue

L'utilisation prévue du produit Allied Vision est son intégration dans des systèmes de vision par le soin de professionnels. Tout produit Allied Vision est vendu dans un cadre B2B.

Caméras sans boîtier fermé

Les caméras sans boîtier fermé ou à boîtier incomplet doivent être blindées contre les émissions CEM par le soin de professionnels conformément aux dispositions CEM locales.

עברית - HE

בטיחות

לפני השימוש במצלמה, עליך לקרוא את הוראות הבטיחות האלו. יש לפעול על פי הוראות ביטחון אלו תמיד. השימוש במצלמה הוא רק לפי מה שכתוב ב"השימוש המיועד" (Intended use) בעמוד 62.

זהירות

סכנת כוויה

מצלמה בפעולה עשויה להגיע לטמפרטורות גבוהות שעלולות לגרום לכוויות.



זהירות

פגיעה מנפילת מצלמות או עדשות

מצלמה או עדשה שנופלות עלולות לגרום לפגיעה.



זהירות

סכנה להפצע מקצוות חדים

למוצר יכולים להיות קצוות חדים.



שימוש מיועד

מוצרי AlliedVision מיועדים לשילוב במערכות ממוחשבת לעיבוד צילומים ע"י אנשי מקצוע. כל מוצרי AlliedVision נמכרים לשימוש בסביבת B2B.

מצלמות ללא מארז סגור

מצלמות ללא מארז, או עם מארז חלקי בלבד, חייבות להיות מוגנות בפני קרינה אלקטרומגנטית (EMC) על ידי אנשי מקצוע בהתאם לתקנים המקומיים (EMC).

IT - Italiano

Sicurezza

Leggere queste istruzioni per la sicurezza prima di utilizzare la telecamera. Osservare sempre tutte le avvertenze. Utilizzare la telecamera come descritto alla sezione [Intended use](#) a pagina 62.



ATTENZIONE

Pericolo di ustioni

Durante il funzionamento una telecamera può raggiungere temperature elevate che possono essere causa di ustioni.



ATTENZIONE

Lesioni dovute alla caduta di telecamere o lenti

La caduta di una telecamera o di una lente può causare delle lesioni.



ATTENZIONE

Pericolo di tagliarsi sui bordi affilati

I bordi del prodotto lente possono essere affilati.

Uso previsto

Il prodotto Allied Vision è concepito per essere integrato in sistemi di monitoraggio in campo professionale. Tutti i prodotti Allied Vision sono venduti in uno scenario B2B.

Telecamere senza custodia chiusa

Le telecamere senza custodia o con una custodia incompleta devono essere protette dalle emissioni elettromagnetiche in ambienti professionali in conformità con le norme CEM nazionali.

JA - 日本語

安全性

本カメラを使用する前に、この安全の手引きをお読みください。常に、警告事項を守ってください。必ず、[Intended use](#) 62 ページの通りに、本カメラを使用してください。



注意

やけどの危険性

作動中のカメラは、やけどを引き起こす温度まで熱くなる恐れがあります。



注意

カメラまたはレンズの落下によるけが

カメラまたはレンズが落下すると、けがをする恐れがあります。



注意

な端部で切り傷の危険性

本製品には鋭利な部分がある場合があります。

用途

Allied Vision製品は、専門家が視覚装置に統合することを意図したものです。すべてのAllied Vision製品は、企業間取り引き用に販売されています。

ハウジングで閉じられていないカメラ

ハウジングのないカメラまたはハウジングが不完全なカメラは、現地の電磁両立性（EMC）規定に従い、専門家によって、EMCエミッションから保護される必要があります。

NL - Nederlands

Veiligheid

Lees deze veiligheidsinstructies voordat u de camera gaat gebruiken. Neem deze waarschuwingen altijd in acht. Gebruik de camera uitsluitend, zoals aangegeven in het [Intended use](#) op pagina 62.



VOORZICHTIG

Risico van verbranding

Een camera die gebruikt wordt, kan temperatuurwaarden bereiken die brandwonden kunnen veroorzaken.



VOORZICHTIG

Letsel door vallende camera's of lenzen

Een vallende camera of lens kan letsel veroorzaken.



VOORZICHTIG

Risico van snijwonden door scherpe randen

Het product kan scherpe randen hebben.

Beoogd gebruik

Het beoogde gebruik van het Allied Vision-product is de integratie in optische systemen door professionals. Alle Allied Vision-producten worden verkocht in de B2B-markt.

Camera's zonder gesloten behuizing

Camera's zonder behuizing of met een onvolledige behuizing moeten door professionals worden beschermd tegen EMC-straling door EMC-beschermingen ter plaatse.

NO - Norsk

Sikkerhet

Les disse sikkerhetsinstruksene før du bruker kameraet. Følg advarslene til en hver tid. Bruk kun kameraet i samsvar med [Intended use](#) på side 62.



FORSIKTIG

Risiko for brannskader

Et kamera i bruk kan nå temperaturnivåer som kan forårsake brannskader.



FORSIKTIG

Skade ved fallende kameraer eller linser

Et fallende kamera eller en fallende linse kan forårsake skade.



FORSIKTIG

Risiko for kutt fra skarpe kanter

Produktet kan ha skarpe kanter.

Tiltenkt bruk

Den tiltenkte bruken av Allied Vision-produktet er integrering i visjonssystemer av profesjonelle. Alle Allied Vision-produkter selges i en forretning til forretning-situasjon.

Kameraer uten lukkede kamerahus

Kameraer uten kamerahus eller med ufullstendige kamerahus må beskyttes mot EMC-utslipp av fagfolk i henhold til lokale EMC-bestemmelser.

SV - Svenska

Säkerhet

Läs igenom säkerhetsinstruktionerna innan du använder kameran. Var hela tiden särskilt uppmärksam på varningarna. Använd enbart kameran på det sätt som anges i [Intended use](#) på sida 62.



VARNING

Risk för brännskada

En kamera i drift kan komma upp i temperaturer som kan orsaka brännskador.



VARNING

Risk för skador från fallande kameror eller objektiv

Fallande kameror eller objektiv kan förorsaka skador.



VARNING

Risk för skärsår från vassa kanter

Produkten kan ha vassa kanter.

Avsedd användning

Den avsedda användningen av Allied Vision-produkter är integrering i visionssystem av fackmän. Samtliga Allied Vision-produkter säljs i en B2B-miljö.

Kameror utan slutna kamerahus

Kameror utan eller med ofullständiga kamerahus måste skyddas mot elektromagnetiska emissioner av fackmän enligt lokala bestämmelser för elektromagnetiska emissioner.

ZH - 简体中文版

安全需知

使用本相机前，请阅读本安全说明书。请务必遵守相关警告和 [Intended use](#) 于第 62 页。



注意事项

烫伤风险

相机操作过程中温度可能上升并导致烫伤风险。



注意事项

相机或者镜头跌落造成伤害

相机或者镜头可能会跌落并造成伤害。



注意事项

锋利边缘割伤的风险

产品可能有锋利的边缘。

预期用途

Allied Vision 产品的预期用途是由专业人士整合到视觉系统中。所有 Allied Vision 的产品均通过 B2B 渠道销售。

无封闭式外壳相机

使用不带外壳或外壳不完整的相机时，必须由专业人员根据当地的 EMC 规定，对其进行 EMC 屏蔽。

Alvium USB cameras at a glance



Get an overview of Alvium USB camera documentation:

Consider for Alvium USB cameras	16
Shipping contents.....	16
What else do you need?	16
Alvium Flex- more flexibility	17
Alvium Frame- use your own optical mount	19
Alvium Pol- using polarization	20

Consider for Alvium USB cameras

Please read the following to better understand your Alvium USB camera and to setup your application smoothly:

- [Exposure time and frame rates](#) on page 77
- Alvium USB properties: [Performance and troubleshooting](#) on page 313
- [User sets](#) on page 248, including supported features and trigger features
- Reducing the power consumption: [DevicePowerSavingMode](#) on page 323
- [Bare board cameras](#) on page 270

Shipping contents

- Alvium USB camera
- Download Instructions for First Camera Operation document

What else do you need?

This is a selection of helpful downloads:

Download	Link
Alvium Cameras Features Reference	www.alliedvision.com/en/support/technical-documentation/alvium-usb-documentation
Application notes	
Alvium Modular Concept for extended hardware options, such as Alvium Frame or Flex.	
Vimba X SDK for Windows, Linux, Linux/ARM, and macOS, including Vimba X Viewer , Firmware Updater , and Driver Installer for Windows	www.alliedvision.com/en/products/software/vimba-x-sdk
Firmware downloads	www.alliedvision.com/en/support/firmware-downloads
STEP files	Downloads for standard Alvium USB models: www.alliedvision.com/en/camera-selector
	Downloads for Alvium Flex or Frame: www.alliedvision.com/en/support/alvium-step-file-downloads
Assembling Alvium Cameras from CAD Components (application note)	www.alliedvision.com/en/support/technical-documentation/alvium-usb-documentation
Accessories , such as interface cables and cards, power and I/O cables, power supplies, lenses, and tripod adapters	www.alliedvision.com/en/products/accessories

Table 1: Downloads for Alvium USB cameras

Alvium Flex - more flexibility

Hardware options for standard Alvium cameras support various digital interfaces, housings, and lens mounts to enable a wide range of applications.

You have found that Alvium USB cameras with USB 3.0 Micro-B connector do not offer enough flexibility for your application? You want to use your own cables and connectors?

Alvium Flex cameras with Hirose DF40C-50DP-0.4V board-to-board connector enable individual connections. Alvium Flex accessories can be used for developing and first testing. Figure 1 shows how Add-on Boards connect to Alvium Flex cameras.

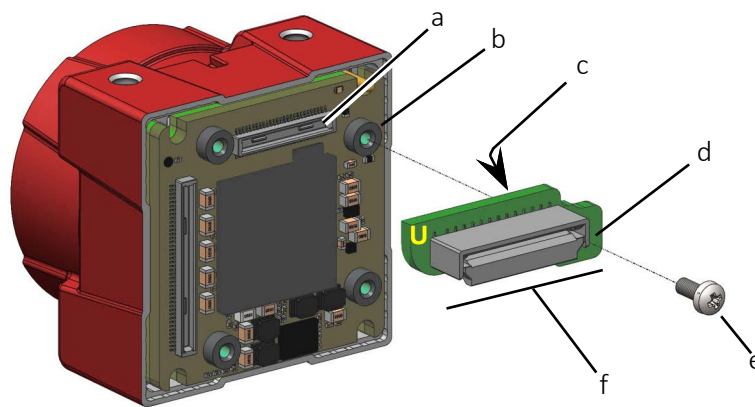

Figure 1: Alvium USB Flex camera, Interface Board, and screw

- a: Hirose DF40C-50DP-0.4V camera connector
- b: Mounting thread
- c: Hirose DF40C-50DS-0.4V board connector
- d: Mounting hole
- e: Fastening screw
- f: Add-on Board

Alvium USB Flex

The following options are offered for **Alvium USB Flex** cameras. Above developing and testing, Alvium Flex can solve typical issues with **standard Alvium USB** cameras.

Individual solutions

Hirose DF40 board-to-board connector enables individual connections to your own boards and cables.

Off-the-shelf solutions

You are about to build an Alvium USB camera into your machine, but you want to separate the connectors for USB and I/Os from the camera back panel? Or you prefer to connect your Alvium USB camera to your own board without using clumsy USB cables? **Alvium USB Flex Interface Board Screw-on** enables moving the standard back panel to a new position, and it supports individual solutions.

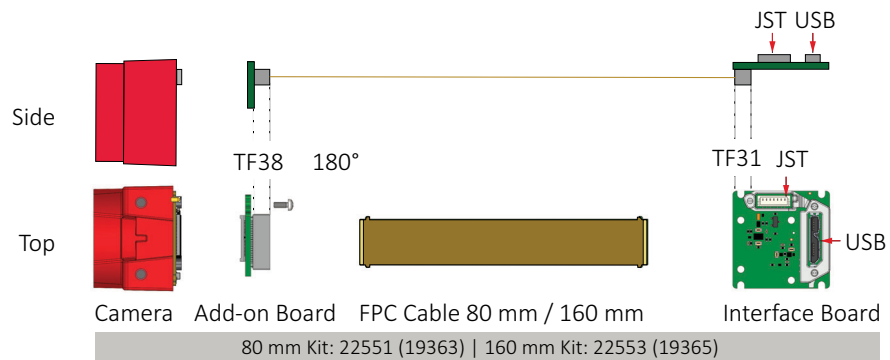

Figure 2: **Alvium USB Flex** camera connections with Interface Board Screw-on

Alvium USB Flex Interface Board Compact supports solutions for minimum space.

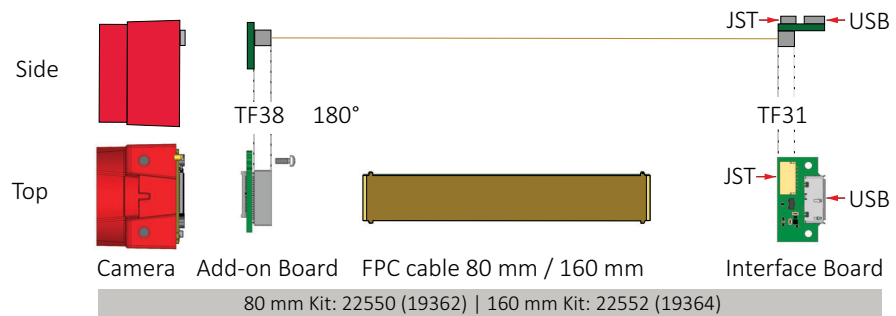

Figure 3: **Alvium USB Flex** camera connections with Interface Board Compact



Alvium USB Flex accessory kits without interface boards

USB Add-on Board + FPC Cable 80 mm: 19367

USB Add-on Board + FPC Cable 160 mm: 19368

Alvium Flex cameras

See contents in [Specifications](#) on page 72 and in [Camera interfaces](#) on page 289.



Alvium Flex accessories and instructions

See the Alvium Flex Design and Accessory Guide at www.alliedvision.com/en/support/technical-documentation/alvium-usb-documentation.

Alvium Frame - use your own optical mount

You want to design your own lens mount for Alvium USB cameras or your application does not need a lens mount? In this case, Alvium Frame adds more flexibility. The square front flange with only 10 mm depth aligns to your individual housing with an extremely high accuracy.

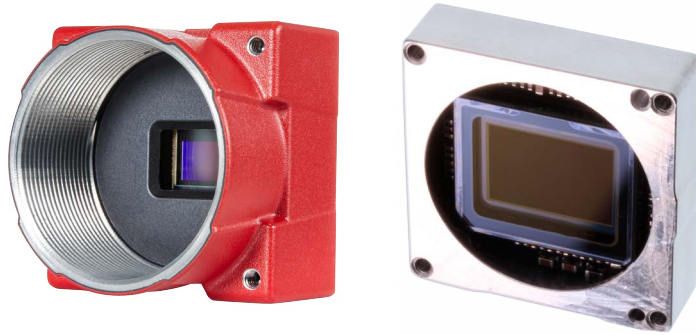

Figure 4: Standard Alvium USB open housing (left) vs. Alvium USB Frame (right)

Specifications

- [Alvium Frame: Dimensions and mass](#) on page 240
- [Alvium Frame: Technical drawings](#) on page 240
- [Sensor position accuracy](#) on page 245

Instructions

[Installing Alvium Frame cameras](#) on page 276:

- [Aligning the sensor with your optical system](#) on page 276
- [Mounting Alvium Frame](#) on page 278



Ordering Alvium Frame cameras

See the Alvium Modular Concept at www.alliedvision.com/en/support/technical-documentation/alvium-usb-documentation.



Alvium Frame Flex

You can combine hardware options for Alvium USB Frame Flex cameras.

Alvium Pol - using polarization

Alvium polarizer cameras are equipped with Sony IMX Polarsens sensors that support four-directional polarization using filters directly in front of the sensor. With these cameras, you can replace additional polarizer filters on the lens used in typical applications. In many cases, polarizer sensors can adapt easily to setups with varying polarization angles; there is no need to change or rotate optical polarization filters anymore.

You can use polarized light imaging, for example, to reduce reflections or for surface analysis regarding stress and defects. Figure 5 shows how the orientation of the polarization filters affects brightness values for the sub-images:



Figure 5: Polarization angle versus image brightness in sub-images

Current models:

- [Alvium 1800 U-507m/c Pol](#) on page 157
- [Alvium 1800 U-508m/c Pol](#) on page 164



Please observe

For first series models, pixel processing has not been adjusted to enable the complete functionality available with non-polarizer models:

- Only raw pixel formats are supported, but no formats for polarizer sensors.
- Features based on pixel processing are available but cannot be used to generate a proper output. For example, color processing, binning, convolution filter, DPC, or FPNC are not supported.



More information

See the Pixel based polarizer application note at www.alliedvision.com/en/support/technical-documentation/alvium-usb-documentation.

Contact us

Website, email

General

www.alliedvision.com/en/contact

info@alliedvision.com

Distribution partners

www.alliedvision.com/en/avt-locations/avt-distributors

Support

www.alliedvision.com/en/support

www.alliedvision.com/en/about-us/contact-us/technical-support-repair/-/rma

Offices

Europe, Middle East, and Africa (Headquarters)

Allied Vision Technologies GmbH

Taschenweg 2a

07646 Stadtroda, Germany

T// +49 36428 677-0 (Reception)

T// +49 36428 677-230 (Sales)

F// +49 36428 677-28

North, Central, and South America, Canada

Allied Vision Technologies Canada Inc.

300 – 4621 Canada Way

Burnaby, BC V5G 4X8, Canada

T// +1 604 875 8855

USA

Allied Vision Technologies, Inc.

102 Pickering Way- Suite 502

Exton, PA 19341, USA

Toll-free// +1-877-USA-1394

T// +1 978 225 2030

Asia-Pacific

China

Allied Vision Technologies Shanghai Co Ltd.

B-510, Venture International Business Park

2679 Hechuan Road

Minhang District, Shanghai 201103

People's Republic of China

T// +86 21 64861133

Japan

Allied Vision Technologies

Yokohama Portside Bldg. 10F

8-1 Sakae-cho, Kanagawa-ku

Yokohama-shi, Kanagawa, 221-0052

T// +81 (0) 45 577 9527

Singapore

Allied Vision Technologies Asia Pte. Ltd

82 Playfair Rd, #07-01 D'Lithium

Singapore 368001

T// +65 6634 9027

Contents

Read before use	2
EN - English	2
DA - Dansk	3
DE - Deutsch	4
ES - Español	5
FI - Suomi	6
FR - Français	7
HE - עברית	8
IT - Italiano	9
JA - 日本語	10
NL - Nederlands	11
NO - Norsk	12
SV - Svenska	13
ZH - 简体中文版	14
Alvium USB cameras at a glance	15
Consider for Alvium USB cameras	16
Shipping contents	16
What else do you need?	16
Alvium Flex - more flexibility	17
Alvium USB Flex	17
Individual solutions	17
Off-the-shelf solutions	18
Alvium Frame - use your own optical mount	19
Specifications	19
Instructions	19
Alvium Pol - using polarization	20
Contact us	21
Document history and conventions	31
Document history	32
Conventions used in this user guide	54
Typographic styles	54
Symbols and notes	55
Naming and terms	56
Camera model naming	56
Terms and acronyms	56
Compliance, safety, and intended use	58
Camera identification	59
Compliance notifications	59
For customers in the USA	60
United States of America: Supplier Declaration of Conformity	60
Party issuing Supplier's Declaration of Conformity	60

Responsible Party - U.S. Contact Information	60
For customers in Canada	61
Pour utilisateurs au Canada	61
Bare board and open housing cameras	61
Avoid electromagnetic interferences	61
Intended use	62
Copyright and trademarks	62
Your safety	62
Handling lens mounts and Alvimium Frame	62
Handling hot cameras	63
Providing optimum heat dissipation	63
Camera mounting	64
Heavy lenses	64
How to avoid product damage	65
Electrical connections	65
ESD	65
Cable connections	65
PCBAs	65
Camera power	66
GPIOs	66
Ground loops	66
Hirose DF40C-50DP-0.4V connectors	67
USB connections	67
Handling bare board cameras	68
Optical components	68
Sensor	69
Lenses	70
Mechanical components	71
Heat sinks	71
Conductive media for heat sinks	71
BIOS drivers	71
Specifications	72
Applied standards	73
GenICam	73
USB3 Vision 1.1	73
IP class	73
Shock and vibration	74
IEC 60068-2-6: Sinusoidal vibration	74
IEC 60068-2-27: Shock	75
IEC 60068-2-64: Random vibration	75
Notes on specifications	76
Sensor	76
Measurements for QE and spectral response	76
Absolute QE plots	76
Spectral response plots	76
Exposure time and frame rates	77
Specified values	77
Factors for exposure time and frame rates	77

Sensor ADC readout modes for maximum frame rates	77
Exposure time behavior regarding ExposureMode.	78
Operation for maximum frame rates	79
Frame rates with rolling shutter sensors	79
Sensor shutter types.	80
Brightness with 1800 U-812 UV cameras	81
Digital binning	81
Sensor binning.	82
Multiple regions	82
Available subregion resolutions	83
Operation for medium power consumption	85
Dimensions and mass.	85
Alvium 1800 U model specifications	86
Alvium 1800 U-030 VSWIR.	86
Absolute QE	87
ROI frame rates	88
Alvium 1800 U-040m/c	89
Absolute QE	91
Spectral response.	91
ROI frame rates	92
Alvium 1800 U-050m/c	93
Absolute QE	95
Spectral response.	95
ROI frame rates	96
Alvium 1800 U-052m/c	97
Absolute QE	99
Spectral response.	99
ROI frame rates	100
Alvium 1800 U-120m/c	101
Absolute QE	103
Spectral response.	103
ROI frame rates	104
Alvium 1800 U-130 VSWIR.	105
Absolute QE	106
ROI frame rates	107
Alvium 1800 U-131m/c	108
Absolute QE, spectral response	110
ROI frame rates	110
Alvium 1800 U-158m/c	111
Absolute QE	113
Spectral response.	113
ROI frame rates	114
Alvium 1800 U-192m/c	115
Absolute QE, spectral response	117
ROI frame rates	117
Alvium 1800 U-203m/c	118
Absolute QE	120
Spectral response.	120

ROI frame rates	121
Alvium 1800 U-234m/c	122
Absolute QE	124
Spectral response	124
ROI frame rates	125
Alvium 1800 U-235m/c	126
Absolute QE	128
Spectral response	128
ROI frame rates	129
Alvium 1800 U-240m/c	130
Absolute QE	132
Spectral response	132
ROI frame rates	133
Alvium 1800 U-291m/c	134
Absolute QE	136
Spectral response	136
ROI frame rates	137
Alvium 1800 U-319m/c	138
Absolute QE	140
Spectral response	140
ROI frame rates	141
Alvium 1800 U-320 VSWIR	142
Absolute QE	143
ROI frame rates	144
Alvium 1800 U-500m/c	145
Absolute QE	147
Spectral response	147
ROI frame rates	148
Alvium 1800 U-501m/c NIR	149
Absolute QE	151
Spectral response	151
ROI frame rates	152
Alvium 1800 U-507m/c	153
Absolute QE	155
Spectral response	155
ROI frame rates	156
Alvium 1800 U-507m/c Pol	157
Absolute QE, spectral response	158
ROI frame rates	159
Alvium 1800 U-508m/c	160
Absolute QE	162
Spectral response	162
ROI frame rates	163
Alvium 1800 U-508m/c Pol	164
Absolute QE, spectral response	165
ROI frame rates	166
Alvium 1800 U-510m/c	167
Absolute QE	169

Spectral response.....	169
ROI frame rates	170
Alvium 1800 U-511m/c	171
Absolute QE	173
Spectral response.....	173
ROI frame rates	174
Alvium 1800 U-530 VSWIR.....	175
Absolute QE	176
ROI frame rates	177
Alvium 1800 U-811m/c	178
Absolute QE	180
Spectral response.....	180
ROI frame rates	181
Alvium 1800 U-812 UV.....	182
Absolute QE	183
ROI frame rates	184
Alvium 1800 U-895m/c	185
Absolute QE	187
Spectral response.....	187
ROI frame rates	188
Alvium 1800 U-1236m/c	189
Absolute QE	191
Spectral response.....	191
ROI frame rates	192
Alvium 1800 U-1240m/c	193
Absolute QE	195
Spectral response.....	195
ROI frame rates	196
Alvium 1800 U-1242m/c	197
Absolute QE	199
Spectral response.....	199
ROI frame rates	200
Alvium 1800 U-1620m/c	201
Absolute QE	203
Spectral response.....	203
ROI frame rates	204
Alvium 1800 U-2040m/c	205
Absolute QE	207
Spectral response.....	207
ROI frame rates	208
Alvium 1800 U-2050m/c	209
Absolute QE	211
Spectral response.....	211
ROI frame rates	212
Alvium 1800 U-2460m/c	213
Absolute QE	215
Spectral response.....	215
ROI frame rates	216

White balance default.	217
Standard Alvium: Dimensions and mass	218
Bare board	218
Open housing 180° (standard orientation)	218
Open housing 90°	219
Closed housing 180° (standard orientation)	219
Closed housing 90°	219
Standard Alvium: Technical drawings	220
Bare Board 180° (standard Alvium).	221
Bare Board 90° (standard Alvium)	221
Values in Bare Board drawings	221
Open Housing C-Mount 180° (standard Alvium)	223
Open Housing CS-Mount 180° (standard Alvium)	224
Open Housing S-Mount 180° (standard Alvium)	225
Open Housing C-Mount 90° (standard Alvium)	226
Open Housing CS-Mount 90° (standard Alvium)	227
Open Housing S-Mount 90° (standard Alvium)	228
Closed Housing C-Mount 180° (standard Alvium)	229
Closed Housing CS-Mount 180° (standard Alvium)	230
Closed Housing S-Mount 180° (standard Alvium)	231
Closed Housing C-Mount 90° (standard Alvium)	232
Closed Housing CS-Mount 90° (standard Alvium)	233
Closed Housing S-Mount 90° (standard Alvium)	234
Alvium Flex: Dimensions and mass	235
Bare board	235
Open housing	235
Alvium Flex: Technical drawings	236
Bare Board (Alvium Flex)	236
Open Housing C-Mount (Alvium Flex).	237
Open Housing CS-Mount (Alvium Flex).	238
Open Housing S-Mount (Alvium Flex).	239
Alvium Frame: Dimensions and mass	240
Alvium Frame: Technical drawings	240
Alvium Frame 180°	240
Alvium Frame 90°	241
Alvium Frame Flex: Dimensions and mass	241
Alvium Frame Flex: Technical drawings.	242
Maximum protrusion for front mounts.	243
IR cut filter	244
Sensor position accuracy	245
Housed standard and Flex cameras: Sensor shift and rotation	245
Housed Alvium Frame: Sensor shift and rotation	246
Housed Alvium USB cameras: Sensor tilt	246
User sets.	248
Supported features.	248
Trigger features and UserSetDefault.	248
Camera feature availability.	249

Lenses: Focal length vs. field of view	252
About this chapter	253
Parameters in tables	253
Optical vignetting with certain lenses	253
About S-Mount lenses	254
Focal length vs. field of view	254
Alvium 1800 U-030 VSWIR	254
Alvium 1800 U-040m/c	255
Alvium 1800 U-050m/c	255
Alvium 1800 U-052m/c	256
Alvium 1800 U-120m/c	256
Alvium 1800 U-130 VSWIR	257
Alvium 1800 U-131m/c	257
Alvium 1800 U-158m/c	258
Alvium 1800 U-192m/c	258
Alvium 1800 U-203m/c	259
Alvium 1800 U-234m/c, 1800 U-235m/c	259
Alvium 1800 U-240m/c	260
Alvium 1800 U-291m/c	260
Alvium 1800 U-319m/c	261
Alvium 1800 U-320 VSWIR	261
Alvium 1800 U-500m/c, 1800 U-501m/c NIR	262
Alvium 1800 U-507m/c, 1800 U-507m/c Pol, 1800 U-508m/c, 1800 U-508m/c Pol	262
Alvium 1800 U-510m/c, 1800 U-511m/c	263
Alvium 1800 U-530 VSWIR	263
Alvium 1800 U-811m/c, 1800 U-812 UV	264
Alvium 1800 U-895m/c	264
Alvium 1800 U-1236m/c	265
Alvium 1800 U-1240m/c	265
Alvium 1800 U-1242m/c	266
Alvium 1800 U-1620m/c	266
Alvium 1800 U-2040m/c	267
Alvium 1800 U-2050m/c	267
Alvium 1800 U-2460m/c	268
Installing the camera	269
Touching hot cameras	270
Sensor damage by ESD	270
Bare board cameras	270
Serial numbers of Alvium® chips and bare board cameras	271
Mounting the heat sink	272
Mounting the camera	273
Mounting bare board cameras	273
Mounting housed standard cameras	275
Bottom or top mounting	275
Front mounting	275
Installing Alvium Frame cameras	276
Aligning the sensor with your optical system	276

Mounting Alvium Frame	278
Adapting maximum torque values	279
Mounting the lens	279
Mounting and focusing S-Mount lenses	280
Software and driver installation on the host	283
Required components	283
Connecting the camera to the host	284
Connecting USB cables	284
Installing the camera driver using Vimba X on a Windows system	284
Using the camera with third-party drivers	284
Installing drivers for camera and host adapter	284
Installing the host adapter and Vimba X	284
Installing the camera driver	285
Installing the camera driver with Windows tools	287
Camera interfaces	289
Standard Alvium and Alvium Frame: Connections	290
Recommended accessories	290
Back panel	290
I/O connector pin assignment	291
Alvium Flex: Connections	293
Observe for DF40C-50DP-0.4V connectors	293
Back panel	293
DF40C 50DP-0.4V connector pin assignment	293
All Alvium USB: Connections	297
I/O use for UART	297
Power supply voltage for I/O cables	297
Compensation	297
Non-isolated, programmable GPIOs	298
GPIOs description	298
Input levels	299
Output levels	299
Status LED	300
Normal operation	300
Error conditions	300
Triggering and timings	301
Trigger signal flow	302
Trigger latency	302
Trigger features and UserSetDefault	303
Trigger delay with 1800 U-120 cameras	303
Triggering with rolling shutter cameras	303
Ignored triggers	304
Image data flow	305
Image data flow diagram	306
FPNC support	307
Firmware update	308

Please note.	309
Firmware update with Vimba X	309
Updating the firmware.	310
Error handling	312
Performance and troubleshooting	313
Optimizing performance.	314
Image transfer with rolling shutter cameras	314
Parameter changes.	314
Stopped streaming.	314
Frame rate jitter	314
Value changes by feature interdependencies	315
Effects for the interdependent features	315
Impact by other features.	316
Exposure times and frame rates with Sony IMX rolling shutter cameras	316
Dark current compensation	316
Additional compensation.	317
Black level compensation for 1800 U-050m/c.	318
Shutter types affecting image readout.	319
Host setup and bandwidth.	320
Sensor data output and camera data output	320
Vimba X settings.	321
Requirements for USB PCIe cards and host controllers	321
Shared bandwidth on a common USB bus	322
Ideal setup for two cameras	322
Best practice for bandwidth management	322
Cascading hubs divide bandwidth	322
DevicePowerSavingMode.	323
Using SuspendMode under Linux	324
Using SuspendMode under Windows	325
Power consumption issues	326
Ensure sufficient power supply.	326
Reduce the power consumption.	327
Troubleshooting common issues	327
Camera recognition	328
Unexpected events.	329
Performance	330
Radio signal interference	331
Index	332

Document history and conventions



This chapter includes:

Document history	32
Conventions used in this user guide.....	54
Naming and terms	56

Document history

Version	Date	Remarks
V5.1.0	2025-Nov-17	<p>Firmware version</p> <ul style="list-style-type: none"> Alvium 1800 U main firmware: 00.14.01.d83c7207 Alvium 1800 U-131, 1800 U-192: 00.13.01.794391f9 Alvium 1800 U-050: 00.11.00.9cf0c21e <p>Applied changes</p> <ul style="list-style-type: none"> Corrected swapped H and V values for multiple ROI in the tables with Alvium 1800 U model specifications on page 86. For improved housings, updated data: <ul style="list-style-type: none"> Replaced technical drawings in Standard Alvium: Technical drawings on page 220 and in Alvium Flex: Technical drawings on page 236. Updated maximum lengths for screws and maximum torque values in Mounting the camera on page 273. Added a note for Alvium Flex and Frame cameras in Shock and vibration on page 74. Applied editorial changes.
V5.0.1	2025-Jul-14	<p>Firmware version</p> <ul style="list-style-type: none"> Alvium 1800 U main firmware: 00.14.01.d83c7207 Alvium 1800 U-131, 1800 U-192: 00.13.01.794391f9 Alvium 1800 U-050: 00.11.00.9cf0c21e <p>Applied changes</p> <ul style="list-style-type: none"> Removed UKCA logo from Compliance notifications on page 59. Removed contents for ISO 13485 and updated definitions for Intended use on page 62. Updated Handling hot cameras on page 63. Added a note for optical cleaning in Sensor cleanliness on page 69. <p>Continued on the next page.</p>

Table 2: Document history (sheet 1 of 23)

Version	Date	Remarks
V5.0.1	2025-Jul-14	<p>Firmware version</p> <ul style="list-style-type: none"> Alvium 1800 U main firmware: 00.14.01.d83c7207 Alvium 1800 U-131, 1800 U-192: 00.13.01.794391f9 Alvium 1800 U-050: 00.11.00.9cf0c21e <p>Continued from previous page.</p> <ul style="list-style-type: none"> In Specifications on page 72, updated information for frame rates when color models of Alvium 1800 U-1240 and 1800 U-2050 are operated in triggered mode. (Preliminary changes were already added with V5.0.0 of this document.) Changed supported sensor binning mode to 2 × 2 (<i>Sum</i>) for 1800 U-500 and 1800 U-501 NIR in Specifications on page 72. Updated I/O descriptions in Table 143: Pin assignment of the JST BM07B-SRSS-TBT type I/O connector on page 292 and in Table 144: Hirose DF40C-50DP-0.4V connector pin assignment on page 295. Updated graphics for DF40C-50DP-0.4V connector in Back panel on page 293. For selected camera models, added support to monitor the sensor temperature in Camera feature availability on page 249. Renamed Type IRC Hoya C-5000 filter to Type IRC 625 colored glass filter in IR cut filter on page 244. Applied editorial changes.

Table 2: Document history (sheet 2 of 23)

Version	Date	Remarks
V5.0.0	2025-Feb-13	<p>Firmware version</p> <ul style="list-style-type: none"> • Release: Alvium 1800 U main firmware: 00.14.01.d83c7207 • Alvium 1800 U-131, 1800 U-192: 00.13.01.794391f9 • Alvium 1800 U-050: 00.11.00.9cf0c21e <p>Applied changes</p> <ul style="list-style-type: none"> • Updated the reference firmware version: Several bugs were fixed, but no features or specifications were changed. • Updated contents for Sensor cleanliness on page 69. • Updated graphic elements in Image data flow diagram on page 306. • Applied editorial changes.
V4.9.0	2024-Nov-07	<p>Firmware version</p> <ul style="list-style-type: none"> • Release: Alvium 1800 U main firmware: 00.14.00.baba1e3c • Alvium 1800 U-131, 1800 U-192: 00.13.01.794391f9 • Alvium 1800 U-050: 00.11.00.9cf0c21e <p>Applied changes</p> <ul style="list-style-type: none"> • Updated the related firmware versions. • Updated contents on KC for simplicity in Compliance notifications on page 59. • Updated values for maximum power consumption in DevicePowerSavingMode on page 323.

Table 2: Document history (sheet 3 of 23)

Version	Date	Remarks
V4.8.0	2024-Oct-01	<p>Firmware versions</p> <ul style="list-style-type: none"> Alvium 1800 U main firmware: 00.13.01.794391f9 Alvium 1800 U-320 VSWIR, -530 VSWIR: 00.13.02.46198eb2 Alvium 1800 U-050: 00.11.00.9cf0c21e <p>Applied changes</p> <ul style="list-style-type: none"> Updates to Read before use on page 2: <ul style="list-style-type: none"> Updated Hebrew safety notes. Added safety notes for Proposition 65 by the State of California. Added macOS support for Vimba X. Updated contents in Providing optimum heat dissipation on page 63 for Alvium VSWIR models. Updated descriptions on bandwidth in Operation for maximum frame rates on page 79. Added contents for <i>Region0</i> in Multiple regions on page 82. <p>Continued on the next page.</p>

Table 2: Document history (sheet 4 of 23)

Version	Date	Remarks
V4.8.0	2024-Oct-01	<p>Firmware versions</p> <ul style="list-style-type: none"> Alvium 1800 U main firmware: 00.13.01.794391f9 Alvium 1800 U-320 VSWIR, -530 VSWIR: 00.13.02.46198eb2 Alvium 1800 U-050: 00.11.00.9cf0c21e <p>Continued from previous page.</p> <ul style="list-style-type: none"> Updates in Alvium 1800 U model specifications on page 86: <ul style="list-style-type: none"> Removed "Coming soon" status for 1800 U-320 VSWIR, -507 Pol, -508 Pol. Replaced calculated values for ROI fps by measured values for 1800 U-320 VSWIR. Added power consumption for 1800 U-320 VSWIR. Added notes for heat dissipation with VSWIR models. Removed contents for Alvium 1800 U-831 and 1800 U-832 from this document. In Image data flow on page 305, added a link to Value changes by feature interdependencies on page 315 for the order of flipping and ROI. Applied editorial changes.
V4.7.4	2024-Jul-23	<p>Firmware versions</p> <ul style="list-style-type: none"> Alvium 1800 U main firmware: 00.13.01.794391f9 Alvium 1800 U-530 VSWIR: 00.13.02.46198eb2 Alvium 1800 U-050: 00.11.00.9cf0c21e <p>Applied changes</p> <p>Replaced calculated values for ROI frames by measured values for Alvium 1800 U-131 and -192 in Alvium 1800 U model specifications on page 86.</p>

Table 2: Document history (sheet 5 of 23)

Version	Date	Remarks
V4.7.3	2024-Jun-25	<p>Firmware versions</p> <ul style="list-style-type: none"> Alvium 1800 U main firmware: 00.13.01.794391f9 Alvium 1800 U-530 VSWIR: 00.13.02.46198eb2 Alvium 1800 U-050: 00.11.00.9cf0c21e <p>Applied changes</p> <ul style="list-style-type: none"> Completed firmware versions in this table for log entries down to V4.0.0. Updated the addresses of Sales offices in Contact us on page 21. Updates in Alvium 1800 U model specifications on page 86: <ul style="list-style-type: none"> Removed "Coming soon" status for 1800 U-131 and -192 models. Added curves for QE and partly for relative response for Alvium 1800 U-052, -203, -291, -320 VSWIR, -530 VSWIR, and -895 models. Updated curves for QE and relative response for Alvium 1800 U-510, -511, -811, and -1242 models.
V4.7.2	2024-Jun-12	<p>Firmware versions</p> <ul style="list-style-type: none"> Alvium 1800 U main firmware: 00.13.01.794391f9 Alvium 1800 U-530 VSWIR: 00.13.02.46198eb2 Alvium 1800 U-050: 00.11.00.9cf0c21e <p>Applied changes</p> <ul style="list-style-type: none"> Updated data for 1800 U-131 and 1800 U-192 models in Alvium 1800 U model specifications on page 86: <ul style="list-style-type: none"> Corrected exposure time values. Changed maximum gain to 12.5 dB. Updated minimum exposure time values for 1800 U-320 VSWIR and -530 VSWIR models in Alvium 1800 U model specifications on page 86. Fixed issues in Camera feature availability on page 249.

Table 2: Document history (sheet 6 of 23)

Version	Date	Remarks
V4.7.1	2024-Jun-06	<p>Firmware versions</p> <ul style="list-style-type: none"> Alvium 1800 U main firmware: 00.13.01.794391f9 Alvium 1800 U-530 VSWIR: 00.13.02.46198eb2 Alvium 1800 U-050: 00.11.00.9cf0c21e <p>Applied changes</p> <ul style="list-style-type: none"> Added notes for white balance with 1800 U-131 and 1800 U-192 models in Specifications on page 72. Added notes for Alvium 1800 U-831 and -832 that ROI frame rates have been calculated in Alvium 1800 U model specifications on page 86. Corrected typos. Applied editorial changes.
V4.7.0	2024-Jun-04	<p>Firmware versions</p> <ul style="list-style-type: none"> Alvium 1800 U main firmware: 00.13.01.794391f9 Release: Alvium 1800 U-530 VSWIR: 00.13.02.46198eb2 Alvium 1800 U-050: 00.11.00.9cf0c21e <p>Applied changes</p> <ul style="list-style-type: none"> Updated the address of the Shanghai office in Contact us on page 21. Removed "Coming soon" status for Alvium 1800 U-530 VSWIR. (Alvium 1800 U-320 VSWIR will be coming soon.) Changes to Specifications on page 72, Focal length vs. field of view on page 254, and in FPNC support on page 307: Added 1800 U-831 and -832 models that will be coming soon. Reduced maximum exposure time for Alvium 1800 U-500 and -501 NIR to 0.48 s in Specifications on page 72. Added QE curves for models coming soon: 1800 U-320 VSWIR and -530 VSWIR in Specifications on page 72. Added a note about Measurements for QE and spectral response on page 76. Added a note in Values in Bare Board drawings on page 221 for calculating Mechanical length to design your own S-Mount models. Applied editorial changes.

Table 2: Document history (sheet 7 of 23)

Version	Date	Remarks
V4.6.2	2024-May-07	<p>Firmware versions</p> <ul style="list-style-type: none"> Alvium 1800 U main firmware: 00.13.01.794391f9 Alvium 1800 U-050: 00.11.00.9cf0c21e <p>Applied changes</p> <ul style="list-style-type: none"> Added model list for KC compliance in Camera identification on page 59. Removed "Coming soon" status for Alvium 1800 U-507 Pol and -508 Pol. Extended contents for <i>StandbyMode</i> in DevicePowerSavingMode on page 323. Applied editorial changes.
V4.6.1	2024-Mar-27	<p>Firmware versions</p> <ul style="list-style-type: none"> Alvium 1800 U main firmware: 00.13.01.794391f9 Alvium 1800 U-050: 00.11.00.9cf0c21e <p>Applied changes</p> <ul style="list-style-type: none"> Reworded Cable connections on page 65 and added contents for using screw-lock USB cables. Added Connecting USB cables on page 284.
V4.6.0	2024-Mar-22	<p>Firmware versions</p> <ul style="list-style-type: none"> Release: Alvium 1800 U main firmware: 00.13.01.794391f9 Alvium 1800 U-050: 00.11.00.9cf0c21e <p>Applied changes</p> <ul style="list-style-type: none"> Added Available subregion resolutions on page 83. Added QE curve for Alvium 1800 U-812 UV on page 182. Added <i>StandbyMode</i> to DevicePowerSavingMode on page 323 and updated descriptions. Applied editorial changes.

Table 2: Document history (sheet 8 of 23)

Version	Date	Remarks
V4.5.0	2024-Mar-05	<p>Firmware versions</p> <ul style="list-style-type: none"> Alvium 1800 U main firmware: 00.13.00.71d891fe Alvium 1800 U-050: 00.11.00.9cf0c21e <p>Applied changes</p> <ul style="list-style-type: none"> Updated title image. Added introduction for Alvium Pol- using polarization on page 20. Added contents for manufacturing conditions regarding Sensor cleanliness on page 69. Added a note that the output bit depth affects the minimum available exposure times in Sensor ADC readout modes for maximum frame rates on page 77. Added contents for Brightness with 1800 U-812 UV cameras on page 81. Added power consumption for 1800 U-131 and -192 models in Alvium 1800 U model specifications on page 86. Updated contents in Specifications on page 72 and in Lenses: Focal length vs. field of view on page 252: <ul style="list-style-type: none"> Added models coming soon: 1800 U-320 VSWIR, -507 Pol, -508 Pol, and -530 VSWIR. Aligned sensor size values to 1 decimal place. Updated exposure time ranges in Alvium 1800 U model specifications on page 86. Added notes that bare board cameras must be aligned by the user in Specifications on page 72 and in Installing the camera on page 269. Reduced options for Temperature monitoring to “mainboard” only in Camera feature availability on page 249. Added information on FPNC support on page 307 and updated corresponding data in Camera feature availability on page 249. Renamed chapter Frame rate jitter to Parameter changes on page 314 and added contents for stopped streaming. Applied editorial changes.

Table 2: Document history (sheet 9 of 23)

Version	Date	Remarks
V4.4.1	2024-Jan-02	<p>Firmware versions</p> <ul style="list-style-type: none"> Alvium 1800 U main firmware: 00.13.00.71d891fe Alvium 1800 U-050: 00.11.00.9cf0c21e <p>Applied changes</p> <p>Fixed broken weblinks.</p>
V4.4.0	2023-Dec-04	<p>Firmware versions</p> <ul style="list-style-type: none"> Release: Alvium 1800 U main firmware: 00.13.00.71d891fe Alvium 1800 U-050: 00.11.00.9cf0c21e <p>Applied changes</p> <ul style="list-style-type: none"> Updated table for Frame rates with rolling shutter sensors on page 79. Extended information on Sensor binning on page 82. Changes to Alvium 1800 U model specifications on page 86: <ul style="list-style-type: none"> Updated frame rates. Changed width resolution for 1800 U-510 and -511 from 2472 to 2464 pixels. (The width resolution for these models is 2464 with all firmware versions. In earlier versions of this user guide, 2472 pixels were specified incorrectly.) Added support for sensor binning for 1800 U-158m, -203m, -240m, -291m, and -508m. Separated Raw color pixel formats from RGB color pixel formats. Removed Packed pixel formats (only supported by Alvium G1 and G5). Updated Camera feature availability on page 249. Edited contents to separate between Alvium USB cameras with USB connector orientations of 90° and 180° in Specifications on page 72.

Table 2: Document history (sheet 10 of 23)

Version	Date	Remarks
V4.3.3	2023-Nov-01	<p>Firmware versions</p> <ul style="list-style-type: none"> Alvium 1800 U main firmware: 00.12.00.00611a22 Alvium 1800 U-050: 00.11.00.9cf0c21e <p>Applied changes</p> <p>Added contents to avoid permanent damage to the sensor by ESD:</p> <ul style="list-style-type: none"> Extended the note for ESD on page 65. Added Possible damage to image sensors due to electrostatic discharge on page 69 in the product safety chapter. Added a warning in Sensor damage by ESD on page 270 in the installation chapter.
V4.3.2	2023-Oct-25	<p>Firmware versions</p> <ul style="list-style-type: none"> Alvium 1800 U main firmware: 00.12.00.00611a22 Alvium 1800 U-050: 00.11.00.9cf0c21e <p>Applied changes</p> <ul style="list-style-type: none"> Corrected mass values for closed housing 1800 U-203 models in Standard Alvium: Dimensions and mass on page 218.
V4.3.1	2023-Oct-05	<p>Firmware versions</p> <ul style="list-style-type: none"> Alvium 1800 U main firmware: 00.12.00.00611a22 Alvium 1800 U-050: 00.11.00.9cf0c21e <p>Applied changes</p> <ul style="list-style-type: none"> Adjusted frame rate values for Alvium 1800 U-131m/c on page 108. Corrected images in Standard Alvium: Technical drawings on page 220. Corrected data for 1800 U-131 and 1800 U-192 in Camera feature availability on page 249.

Table 2: Document history (sheet 11 of 23)

Version	Date	Remarks
V4.3.0	2023-Sep-27	<p>Firmware versions</p> <ul style="list-style-type: none"> Alvium 1800 U main firmware: 00.12.00.00611a22 Alvium 1800 U-050: 00.11.00.9cf0c21e <p>Applied changes</p> <ul style="list-style-type: none"> Added 1800 U-203 models in Specifications on page 72 and in Lenses: Focal length vs. field of view on page 252. Added 1800 U-131 and 1800 U-192 models (coming soon) in Specifications on page 72 and in Lenses: Focal length vs. field of view on page 252. Updated technical drawings for bare board and open housing cameras in Standard Alvium: Technical drawings on page 220. Updated Cooling area for Alvium USB bare board cameras on page 272. Updated Mounting area of Alvium USB bare board cameras connector side (left); sensor side (right) on page 274. Applied editorial changes.
V4.2.3	2023-Aug-08	<p>Firmware versions</p> <ul style="list-style-type: none"> Alvium 1800 U main firmware: 00.12.00.00611a22 Alvium 1800 U-050: 00.11.00.9cf0c21e <p>Applied changes</p> <ul style="list-style-type: none"> Removed "Coming soon" status for Alvium Flex and updated product codes for Alvium Flex accessories in Alvium Flex- more flexibility on page 17. Removed "Coming soon" status for Alvium Frame in Alvium Frame- use your own optical mount on page 19.
V4.2.2	2023-Aug-02	<p>Firmware versions</p> <ul style="list-style-type: none"> Alvium 1800 U main firmware: 00.12.00.00611a22 Alvium 1800 U-050: 00.11.00.9cf0c21e <p>Applied changes</p> <p>Corrected values for length and mass for Alvium Frame: Dimensions and mass on page 240 and Alvium Frame Flex: Dimensions and mass on page 241.</p>

Table 2: Document history (sheet 12 of 23)

Version	Date	Remarks
V4.2.1	2023-Jul-05	<p>Firmware versions</p> <ul style="list-style-type: none"> Alvium 1800 U main firmware: 00.12.00.00611a22 Alvium 1800 U-050: 00.11.00.9cf0c21e <p>Applied changes</p> <ul style="list-style-type: none"> Added 12-bit pixel formats in Alvium 1800 U model specifications on page 86. Changed horizontal resolution for 1800 U-510 and 1800 U-511 in Alvium 1800 U model specifications on page 86.
V4.2.0	2023-Jun-14	<p>Firmware versions</p> <ul style="list-style-type: none"> Alvium 1800 U main firmware: 00.12.00.00611a22 Alvium 1800 U-050: 00.11.00.9cf0c21e <p>Applied changes</p> <ul style="list-style-type: none"> Added 1800 U-895m/c models in Alvium 1800 U model specifications on page 86 and in Lenses: Focal length vs. field of view on page 252. Applied editorial changes.
V4.1.0	2023-Jun-06	<p>Firmware versions</p> <ul style="list-style-type: none"> Release: Alvium 1800 U main firmware: 00.12.00.00611a22 Alvium 1800 U-050: 00.11.00.9cf0c21e <p>Applied changes</p> <ul style="list-style-type: none"> Added safety notes for handling sharp edges of Alvium Frame cameras in Read before use on page 2, Handling lens mounts and Alvium Frame on page 62, and Installing Alvium Frame cameras on page 276. Added data on multiple regions and sensor binning for selected models in Alvium 1800 U model specifications on page 86, in Camera feature availability on page 249, and in Image data flow on page 305. Updated maximum frame rates for Alvium 1800 U-1620m/c on page 201 for a resolution of 5328 (H) × 3040 (V). Updated Serial numbers of Alvium® chips and bare board cameras on page 271.

Table 2: Document history (sheet 13 of 23)

Version	Date	Remarks
V4.0.0	2023-Mar-30	<p>Firmware version: 00.11.00.9cf0c21e</p> <ul style="list-style-type: none"> Added contents for Alvium USB Frame in: <ul style="list-style-type: none"> Alvium USB cameras at a glance on page 15 Specifications on page 72 Installing Alvium Frame cameras on page 276. Updated contents for Vimba X. Updated QE curves for 1800 U-030 VSWIR and 1800 U-130 VSWIR in Alvium 1800 U model specifications on page 86. Reduced value for sensor shift with 1800 U-2050 models to 150 µm in Sensor position accuracy on page 245. Added instructions to Firmware update on page 308. Applied editorial changes.
V3.9.1	2023-Feb-24	<p>Firmware version: 00.11.00.9cf0c21e</p> <p>Updated page breaks to improve readability.</p>
V3.9.0	2023-Feb-21	<p>Firmware version: 00.11.00.9cf0c21e</p> <ul style="list-style-type: none"> Updated Hebrew contents in Read before use on page 2. Added contents for Alvium Flex- more flexibility on page 17, in Specifications on page 72 and in Camera interfaces on page 289. Updated Table 100: Bare Board and Bare Board 90° (standard Alvium and Alvium Flex) model specific dimensions and nominal values on page 222. Removed ImageChunkData from Camera feature availability on page 249. Updated Cooling area for Alvium USB bare board cameras on page 272. Applied editorial changes.
V3.8.1	2022-Nov-14	<p>Firmware version: 00.11.00.9cf0c21e</p> <ul style="list-style-type: none"> Added note that lenses are not part of the product. Applied editorial changes.

Table 2: Document history (sheet 14 of 23)

Version	Date	Remarks
V3.8.0	2022-Oct-27	Release: Firmware version: 00.11.00.9cf0c21e <ul style="list-style-type: none"> Updated standard references in Applied standards on page 73. Replaced previous calculated values for ROI frame rates by measured values in Specifications on page 72. Added note on deviations from stated frame rates in Specified values on page 77. Added 1800 U-510m/c models in Alvium 1800 U model specifications on page 86 and in Lenses: Focal length vs. field of view on page 252. Applied editorial changes.
V3.7.5	2022-Oct-19	Firmware version: 00.10.00.6c9062b1 Updated ROI frame rates for 1800 U-234 and 1800 U-235 in Alvium 1800 U model specifications on page 86.
V3.7.4	2022-Sep-22	Firmware version: 00.10.00.6c9062b1 Corrected entries for JST I/O cables in Table 146 on page 298.

Table 2: Document history (sheet 15 of 23)

Version	Date	Remarks
V3.7.3	2022-Sep-20	Firmware version: 00.10.00.6c9062b1 <ul style="list-style-type: none"> Added Hebrew contents to Read before use on page 2. Changed units KB to KByte and Mbps to MByte/s for clarity. Added number for the South Korean KC Safety Certification in Compliance notifications on page 59. Corrected data in Alvium 1800 U model specifications on page 86: <ul style="list-style-type: none"> Max. gain for Alvium 1800 U-030 VSWIR and 1800 U-130 VSWIR was changed to 42 dB. 12-bit pixel formats were added to Alvium 1800 U-234 and 1800 U-235 models. Updated exposure time vales in tables with ROI frame rates for Alvium 1800 U-812 UV. Corrected sensor bit depth values to 10-bit for ROI frame rates of 1800 U-1240. Removed FPNC availability for 1800 U-234 and 1800 U-235. Added a note in Image data flow on page 305 that 1800 U-234 and 1800 U-235 models currently do not support FPNC. Applied editorial changes.
V3.7.2	2022-Aug-05	Firmware version: 00.10.00.6c9062b1 Removed “Coming soon” status for Alvium 1800 U-812 UV on page 182.
V3.7.1	2022-Jul-22	Firmware version: 00.10.00.6c9062b1 <ul style="list-style-type: none"> Added values for minimum and maximum exposure times in Alvium 1800 U model specifications on page 86. Corrected dimensions for screws from M2 to M1.6 in Mounting bare board cameras on page 273.

Table 2: Document history (sheet 16 of 23)

Version	Date	Remarks
V3.7.0	2022-Jul-14	<p>Release: Firmware version: 00.10.00.6c9062b1</p> <ul style="list-style-type: none"> Added Camera identification on page 59, including Model ID for DoC assignment. Added symbol for South Korean KC Safety Certification in Compliance notifications on page 59. Updated data in Specifications on page 72 for: <ul style="list-style-type: none"> ROI frame rates and exposure time ranges Maximum gain for Sony IMX global shutter cameras increased to 48 dB Exposure Mode of various models. Added 1800 U-234m/c, 1800 U-235m/c, and 1800 U-812 UV models in Alvium 1800 U model specifications on page 86 and in Lenses: Focal length vs. field of view on page 252. Added the information that Alvium 1800 U-511 is supplied on request only to Sensor position accuracy on page 245. Added new functionalities to Camera feature availability on page 249. Added warning against voltage levels of serial communication in I/O connector pin assignment on page 291. Added I/O use for UART on page 297. Removed FPNC support for VSWIR models and added DPC support for 1800 U-052 and 1800 U-291 in Image data flow on page 305. Removed the section “Feature value changes on a streaming camera” from Optimizing performance on page 314. Applied editorial changes.
V3.6.4	2022-Apr-12	<p>Firmware version: 00.08.00.6727174b</p> <ul style="list-style-type: none"> Added notes that Alvium 1800 U-052 and 1800 U-291 currently do not support DPC and FPNC to Image data flow on page 305. Applied minor editorial changes.
V3.6.3	2022-Mar-29	<p>Firmware version: 00.08.00.6727174b</p> <p>Re added values for Alvium 1800 U-319c in White balance default on page 217.</p>

Table 2: Document history (sheet 17 of 23)

Version	Date	Remarks
V3.6.2	2022-Mar-25	Firmware version: 00.08.00.6727174b Updated mass values for closed housing Alvium 1800 U-158m/c at Standard Alvium: Dimensions and mass on page 218.
V3.6.1	2022-Mar-17	Firmware version: 00.08.00.6727174b Renamed Alvium 1800 U-030m VSWIR to Alvium 1800 U-030 VSWIR , and Alvium 1800 U-130m VSWIR correspondingly.
V3.6.0	2022-Mar-15	Release: Firmware version: 00.08.00.6727174b <ul style="list-style-type: none"> • Added Sensor ADC readout modes for maximum frame rates on page 77. • Updated conditions for Operation for maximum frame rates on page 79 and renamed Operation for medium power consumption on page 85. • Updated frame rates for model specifications tables and ROI frame rates in Alvium 1800 U model specifications on page 86. • Added note about frame rates in triggered mode for Alvium 1800 U-120m/c on page 101. • Corrected options for Exposure Modes in Alvium 1800 U-1240m/c on page 193. • Added note for non-standard S-Mount hardware options in Sensor position accuracy on page 245. • Added new section on User sets on page 248. • Added Camera feature availability on page 249. • Added information on Ignored triggers on page 304. • Updated workflows in Image data flow on page 305 for new convolution filters, and in Value changes by feature interdependencies on page 315. • Added new section Power consumption issues on page 326 and updated related • Added Requirements for USB PCIe cards and host controllers on page 321. • Applied minor editorial changes.
V3.5.1	2021-Nov-23	Firmware version: 00.07.00.81db3896 <ul style="list-style-type: none"> • Updated links to accessories. • Applied minor editorial changes.

Table 2: Document history (sheet 18 of 23)

Version	Date	Remarks
V3.5.0	2021-Nov-05	Release: Firmware version: 00.07.00.81db3896 <ul style="list-style-type: none"> Added 1800 U-030m and 1800 U-130m models in Specifications on page 72 and in Lenses: Focal length vs. field of view on page 252. Updated information in Digital binning on page 81. Updated the minimum temperature value for operation and storage from +5 °C to -20 °C. Added contents for Power supply voltage for I/O cables on page 297. Updated workflow in Image data flow on page 305 for new LUT and Sharpness. Updated diagram in Value changes by feature interdependencies on page 315. Applied minor editorial changes.
V3.4.2	2021-Aug-17	Firmware version: 00.06.00.35992 <ul style="list-style-type: none"> Added icon for compliance with UKCA in Compliance notifications on page 59. Corrected sensor specifications for Alvium 1800 U-1242m/c on page 197. Applied editorial changes.
V3.4.1	2021-Aug-09	Firmware version: 00.06.00.35992 <ul style="list-style-type: none"> Adjusted conditions for Operation for maximum frame rates on page 79. Corrected binning ranges in the model specifications in Alvium 1800 U model specifications on page 86. Applied editorial changes.

Table 2: Document history (sheet 19 of 23)

Version	Date	Remarks
V3.4.0	2021-Aug-05	<p>Release: Firmware version: 00.06.00.35992</p> <ul style="list-style-type: none"> Added 1800 U-120 model to Frame rate jitter on page 314 and Trigger delay with 1800 U-120 cameras on page 303. Added 1800 U-511m/c, 1800 U-811m/c, and 800 U-1242m/c models in Alvium 1800 U model specifications on page 86. For all models, added Digital binning on page 81. Updated tables with ROI frame rates in Specifications on page 72, with new bandwidth steps, extended to 450 MByte/s. Removed the previous section Performance on reference systems from Optimizing performance on page 314. Added instructions for DevicePowerSavingMode on page 323.
V3.3.0	2021-Apr-12	<p>Release: Firmware version: 00.04.00.34658</p> <ul style="list-style-type: none"> Updated ROI frame rates on page 96 for 1800 U-120m/c models. Added 1800 U-501c NIR, 1800 U-1620m/c, 1800 U-2040m/c, and 1800 U-2460m/c models in Alvium 1800 U model specifications on page 86. Updated mass values in Standard Alvium: Dimensions and mass on page 218. Updated instructions for Mounting the camera on page 273. Applied editorial changes.
V3.2.2	2021-Jan-22	<p>Firmware version: 00.03.00.31919</p> <ul style="list-style-type: none"> Updated pixel formats in Alvium 1800 U model specifications on page 86. Applied editorial changes.

Table 2: Document history (sheet 20 of 23)

Version	Date	Remarks
V3.2.1	2020-Dec-15	<p>Release: Firmware version: 00.03.00.31919</p> <ul style="list-style-type: none"> • Added information on the exposure time offset in Exposure time behavior regarding ExposureMode on page 78. • Updated values for ROI frame rates and for minimum and maximum exposure time in Alvium 1800 U model specifications on page 86. • Added values for White balance default on page 217. • Updated drawings and dimension values for bare board cameras in Standard Alvium: Technical drawings on page 220. • Added information about Serial numbers of Alvium® chips and bare board cameras on page 271. • Added description for push-pull in GPIOs description on page 298. • Added Trigger features and UserSetDefault on page 303. • In Image data flow on page 305, added FPNC support for all models, except for Alvium 1800 U-2050. • Added notes about frame rates for rolling shutter cameras run in triggered mode. • Applied editorial changes.
V3.2.0	2020-Jul-22	<p>Release: Firmware version: 00.02.00.29974</p> <ul style="list-style-type: none"> • Added Alvium 1800 U-240m/c, 1800 U-508m/c, and 1800 U-1240m/c models. • Updated ROI frame rates and pixel formats in Alvium 1800 U model specifications on page 86. • Added QE and spectral response to Alvium 1800 U-2050m/c on page 209. • Extended information in Shock and vibration on page 74. • Updated spectral response graphic in IR cut filter on page 244. • Added Sensor position accuracy on page 245. • Added Read before use on page 2. • Corrected minor errors.

Table 2: Document history (sheet 21 of 23)

Version	Date	Remarks
V3.1.3	2020-Mar-12	Firmware version: 00.01.03.29025 <ul style="list-style-type: none"> • Corrected maximum exposure times. • Added <i>ExposureActive</i> signal to the description of sensor shutter modes. • DPC: Removed specifications into an application note. • FPNC: Updated note in Image data flow on page 305.
V3.1.2	2020-Mar-04	Firmware version: 00.01.03.29025 Applied minor changes.
V3.1.1	2020-Feb-28	Firmware version: 00.01.03.29025 <ul style="list-style-type: none"> • Updated frame rates and exposure time values. • Added information about frame rates with different triggering modes.
V3.1.0	2020-Feb-20	Release: Firmware version: 00.01.03.29025 <ul style="list-style-type: none"> • Added Alvium 1800 U-319m/c, 1800 U-507m/c, 1800 U-1236m/c, and 1800 U-2050m/c models. • Added specifications for DPC. • Updated description for sensor shutter modes.
V3.0.0	2020-Jan-06	Release: Firmware version: 00.01.02.28100 <ul style="list-style-type: none"> • Added Alvium 1800 U-040m/c, 1800 U-158m/c, and 1800 U-501m NIR models.
V2.0.0	2019-Oct-18	Release: Firmware version: 00.01.01.27102 <ul style="list-style-type: none"> • Added Alvium 1800 U-050m/c and 1800 U-120m/c models. • Updated contents about bandwidth. • Updated screenshots for camera driver installation. • Added Dark current compensation on page 316. • Updated technical drawings and dimensions for bare board in Standard Alvium: Technical drawings on page 220. • Restructured contents in Performance and troubleshooting on page 313. • Applied editorial changes.

Table 2: Document history (sheet 22 of 23)

Version	Date	Remarks
V1.1.0	2019-Jul-01	Firmware version: 00.01.00.26405 <ul style="list-style-type: none"> Added missing color pixel formats and removed separate bit depth in Specifications on page 72. Corrected ADC bit depth in specifications for Alvium 1800 U-500m/c on page 145 and in Image data flow on page 305.
V1.0.0	2019-Jun-13	Release: Firmware version: 00.01.00.26405 Release version

Table 2: Document history (sheet 23 of 23)

Conventions used in this user guide

To give this document an easily understood layout and to emphasize important information, the following typographical styles and symbols are used:

Typographic styles

Style	Function
Emphasis	Programs, or highlighting important things
Feature names	Names for GenICam features
<i>Feature options</i>	Options for GenICam features
<i>Input commands</i>	Text or command to type in by the user, selected menu options, or other selectable options
UIElements	Text that is displayed or output by the system, like parts of the GUI, dialog boxes, buttons, menus, important information, or windows titles
Web addresses and references	Links to webpages and internal cross references

Table 3: Typographic styles

Symbols and notes



Warning

Risk is described



CAUTION

Risk of burns

Precautions are described



CAUTION

Injury by falling cameras or lenses

Precautions are described



CAUTION

Risk of cuts by sharp edges

Precautions are described



NOTICE

Material damage

Precautions are described.



Practical tip

Additional information helps to understand or ease handling the camera.



Avoiding malfunctions

Precautions are described.



Additional information

Web address or reference to an external source with more information is shown.

Naming and terms

Camera model naming

Alvium cameras are named to identify model properties.

For example, **Alvium 1800 U-500c** is composed of:

	Alvium	1800	U	500	c
Content	Camera series	Camera series details	Interface	Resolution ¹	Color/monochrome
Examples	Alvium	1500: Basic feature set 1800: Advanced feature set or high-performance sensors	C: MIPI CSI-2 U: USB	500: 5.0 MP 050: 0.5 MP	c: color m: monochrome m NIR: monochrome near infrared

¹Model resolutions may slightly deviate from model naming.

Table 4: Camera model naming

Terms and acronyms

Term or acronym	Description	Reference
bare board	Camera consisting of electronics and sensor on a common printed circuit board (PCB), to be designed into a housing with heat sink and lens mount	Bare Board 180° (standard Alvium) on page 221
CRA	Chief ray angle	Alvium 1800 U-500m/c on page 145
EMVA	European Machine Vision Association	www.emva.org
ERS	Electronic rolling shutter, see RS	Shutter types affecting image readout on page 319
ESD	Electrostatic discharge	ESD on page 65
FCC	Federal Communications Commission	For customers in the USA on page 60
FPNC	Fixed pattern noise correction	Image data flow on page 305
fps	Frames per second	Alvium 1800 U-500m/c on page 145
GenICam	Generic Interface for Cameras, EMVA	www.emva.org
GND	Ground (power)	I/O connector pin assignment on page 291
GPIOs	General purpose inputs and outputs (non-isolated)	GPIOs description on page 298

Table 5: Terms and acronyms (sheet 1 of 2)

Term or acronym	Description	Reference
GRRS	Global reset release shutter, see GRS	Shutter types affecting image readout on page 319
GRS	Global reset shutter, see GRRS	Shutter types affecting image readout on page 319
GS	Global shutter	Shutter types affecting image readout on page 319
H × V	Horizontal × Vertical (sensor resolution)	Alvium 1800 U-500m/c on page 145
KByte	Kilobyte	Alvium 1800 U-500m/c on page 145
MByte/s	Megabytes per second	Alvium 1800 U-500m/c on page 145
MP	Megapixels (see Px)	Alvium 1800 U model specifications on page 86
open housing	Camera housing that is open at the back side to be designed into an encompassing housing with other components	Open Housing S-Mount 180° (standard Alvium) on page 225
Px	Pixels (see MP)	Alvium 1800 U model specifications on page 86
PCBA	Printed circuit board assembly	PCBAs on page 65
QE	Quantum efficiency	Absolute QE on page 147
ROI	Region of interest	ROI frame rates on page 148
RS	Rolling shutter, see ERS	Shutter types affecting image readout on page 319
SFNC	Standard Features Naming Convention (GenICam)	www.emva.org
shutter mode	Value of the ShutterMode feature to select between rolling shutter (RS) and global release shutter (GRS)	Frame rates with rolling shutter sensors on page 79
shutter type	Sensor specific readout, such as rolling shutter (RS) or global shutter (GS)	Shutter types affecting image readout on page 319
S-Mount	M12-Mount	Mounting and focusing S-Mount lenses on page 280

Table 5: Terms and acronyms (sheet 2 of 2)

Compliance, safety, and intended use



This chapter includes:

Camera identification.....	59
Compliance notifications	59
Intended use	62
Copyright and trademarks	62
Your safety.....	62
How to avoid product damage	65

Camera identification

You can identify your Alvium USB **housing camera** like this:

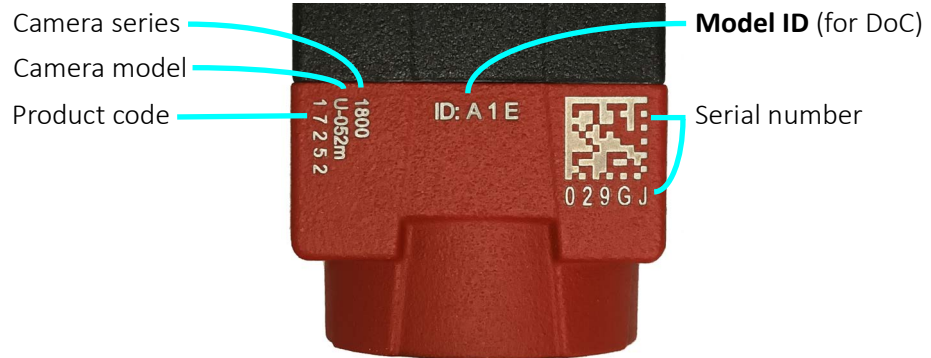

Figure 6: Hardware options and model IDs

Hardware option	Model ID
Closed housing standard Alvium USB	A1E
Open housing standard Alvium USB	A1D
Open housing Alvium USB Flex	A1N
Open housing Alvium USB Frame	A1D
Open housing Alvium USB Frame Flex	A1N

Table 6: Hardware options and model IDs

Model IDs are the same for standard (180°) and 90° USB connector orientation.

Compliance notifications

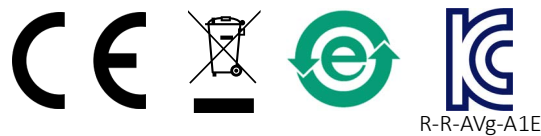

National regulations on disposal must be followed.

Please check with your local Sales representative for KC certified models.

For customers in the USA

Closed housing cameras only: FCC Class B digital device

This equipment has been tested and found to comply with the limits for a Class B digital device, pursuant to part 15 of the FCC Rules. These limits are designed to provide reasonable protection against harmful interference in a residential installation. This equipment generates, uses and can radiate radio frequency energy and, if not installed and used in accordance with the instructions, may cause harmful interference to radio communications. However, there is no guarantee that interference will not occur in a particular installation. If this equipment does cause harmful interference to radio or television reception, which can be determined by turning the equipment off and on, the user is encouraged to try to correct the interference by one or more of the following measures:

- Reorient or relocate the receiving antenna.
- Increase the separation between the equipment and receiver.
- Connect the equipment into an outlet on a circuit different from that to which the receiver is connected.
- Consult the dealer or an experienced radio/TV technician for help.

United States of America: Supplier Declaration of Conformity

Alvium USB cameras comply with Part 15 of the FCC Rules. Operation is subject to the following two conditions:

1. This device may not cause harmful interference, and
2. This device must accept any interference received, including interference that may cause undesired operation.

Party issuing Supplier's Declaration of Conformity

Allied Vision Technologies GmbH
Taschenweg 2a
07646 Stadtroda
Germany
T// +49 (36428) 677-106
quality@alliedvision.com

Responsible Party - U.S. Contact Information

Allied Vision Technologies, Inc.
102 Pickering Way – Suite 502
Exton, PA 19341
USA
T// +1 978 225 2030

Note: changes or modifications not expressly approved by the party responsible for compliance could void the user's authority to operate the equipment.

For customers in Canada

Closed housing cameras only

This apparatus complies with the Class B limits for radio noise emissions set out in the Radio Interference Regulations.

CAN ICES-3 (B) / NMB-3 (B)

Pour utilisateurs au Canada

Boîtier de caméra fermé seulement

Cet appareil est conforme aux normes classe B pour bruits radioélectriques, spécifiées dans le Règlement sur le brouillage radioélectrique.

CAN ICES-3 (B) / NMB-3 (B)

Bare board and open housing cameras

Bare board cameras and open housing cameras are unfinished devices that are not EMC compliant in themselves. To meet EMC requirements, they must be appropriately housed in the customer's device and under the customer's responsibility.



Requirements for EMC housings

See the Electromagnetic Compatibility for Open Housing Alvium Cameras application note at www.alliedvision.com/en/support/technical-documentation/alvium-usb-documentation.

Avoid electromagnetic interferences

Interface cables, power cables, and I/O cables are sensitive to electromagnetic interference.

- Use shielded cables only.
- We recommend using cables offered by Allied Vision.
- Avoid coiling.
- We recommend using GPIOs only in environments with low electromagnetic interference.

Moreover, avoid unnecessary bending to prevent damage to the cables.

Intended use

Allied Vision's objective is the development, design, production, maintenance, servicing and distribution of digital cameras and components for image processing. We are offering standard products as well as customized solutions.

Intended use of Allied Vision product is the integration into Vision systems by professionals. All Allied Vision product is sold in a B2B setting.

Unless expressly agreed otherwise, we design, manufacture, and supply in accordance with the standards of the machine vision industry.

In the event of requirements going beyond this, the customer must:

- Notify us of the special use for each model before the first order is placed so that the models in question can be separated out from the standard processes using their own part numbers, and
- Conclude a quality assurance agreement with us prior to purchasing, to define its requirements in a legally secure manner.

This may require a surcharge, as our prices are very tightly tailored to standard requirements.

Copyright and trademarks

All text, pictures, and graphics are protected by copyright and other laws protecting intellectual property. All content is subject to change without notice.

All trademarks, logos, and brands cited in this document are property and/or copyright material of their respective owners. Use of these trademarks, logos, and brands does not imply endorsement.

Copyright © 2025 Allied Vision Technologies GmbH. All rights reserved.

Your safety

This section informs about issues related to your personal safety. Descriptions explain how to avoid hazards and operate Alvium USB cameras safely.

Handling lens mounts and Alvium Frame

The lens mount thread can have sharp edges. Be careful these edges do not cut your skin when mounting or unmounting lenses.

The circular front opening of Alvium Frame cameras has sharp edges.

- Avoid touching these edges with your fingers.
- Wear protective gloves for handling Alvium Frame cameras with an open circular front opening.
- Follow the instructions in [Installing Alvium Frame cameras](#) on page 276.

Handling hot cameras

If the mainboard temperature exceeds the specified maximum for more than two seconds, the camera is powered off automatically. The current value for mainboard temperature is output by `DeviceTemperature`. You can use this value to control cooling by software, for example, to control a fan.

However, if you hold the camera in your hands during operation, your skin may get hurt. If you touch the camera when it is heated up, we recommend wearing protective gloves.

Providing optimum heat dissipation

Design bare board and open housing cameras into a heat dissipative housing with a high thermal conductivity. For more information, see [Mounting bare board cameras](#) on page 273. Keep the operating temperature in the specified range to enable best image quality and to protect the camera from damage. Temperature values apply to a relative humidity of 0 to 80% that is non-condensing.

Hardware option	Housing	Components in the cooling area ¹	Mainboard ²
Bare board ³	Not applicable	-20 °C to +85 °C	See model Specifications on page 72.
Open housing ⁴	-20 °C to +65 °C	-20 °C to +85 °C	
Closed housing		Not applicable	

¹See [Mounting the heat sink](#) on page 272.

²Output by `DeviceTemperature`

³Ensure that the sensor is operated in the temperature range specified by the manufacturer. For any questions, please visit www.alliedvision.com/en/support.

⁴Temperature values must be observed for the housing **and** for the cooling area.

Table 7: Operating temperature ranges for Alvium USB cameras

For your safety and to improve camera performance, operate the camera:

- Mounted to a base with a high thermal conductivity
- With lens or other optical components mounted
- With a heat sink mounted that has large surface areas (closed housing cameras include a heat sink)
- Using conductive media for camera and heat sink mounting
- With active cooling of camera, mounting base, and heat sink, such as by ventilation.
- Reduce high ambient temperature. For example, in outdoor applications with direct sunlight, provide shading by an enclosure.

See [Figure 7: Setup to provide optimum heat dissipation](#) on page 64.

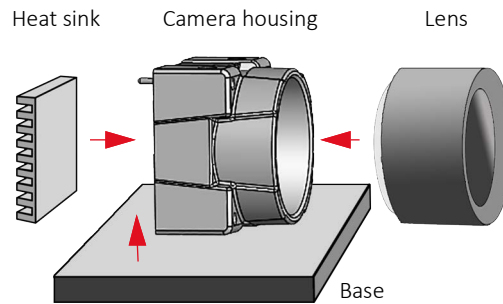

Figure 7: Setup to provide optimum heat dissipation



Heat affecting your application

Generally, image noise is increased by high operating temperatures. Therefore, we recommend you to optimize your application for heat dissipation. This is even more important with Alvium VSWIR models.

For more information on heat dissipation, see the Optimum Heat Dissipation for Housed Alvium Cameras application note at www.alliedvision.com/en/support/technical-documentation/alvium-usb-documentation.

Camera mounting

Housed cameras must be mounted using the mounting threads. If vibration is higher than specified, cameras can disconnect from the mounting base. Falling cameras can hurt you. To avoid personal injury:

- Mount the camera according to the instructions in [Mounting housed standard cameras](#) on page 275.
- Ensure, shock and vibration do not exceed the specified range, see [Shock and vibration](#) on page 74.
- Use a lens support if you want to use [Heavy lenses](#).

Heavy lenses

For non-static applications, use lenses with a mass less than 70 grams and a length less than 38 mm, where the center of gravity is 20 mm, measured from the lens mount front flange. For heavier or longer lenses, use a lens support and apply additional tests. For more information, please contact support at www.alliedvision.com/en/about-us/contact-us/technical-support-repair-/rma.

How to avoid product damage

To prevent material damage, read the following and understand how to safely handle and operate the camera. Get helpful details about electrical connections and learn how to optimize camera performance.

Electrical connections

ESD

Follow these instructions to avoid damage to the camera, including possible **damage to the sensor**, see [Possible damage to image sensors due to electrostatic discharge](#) on page 69. ESD is dangerous for electronic devices, especially when tools or hands get in contact with connectors and electronic components. We recommend measures to avoid damage by ESD:

- Unpacking: Remove the camera from its anti-static packaging only when your body is grounded.
- Workplace: Use a static-safe workplace with static-dissipative mat and air ionization.
- Wrist strap: Wear a static-dissipative wrist strap to ground your body.
- Clothing: Wear ESD clothing. Keep components away from your body and clothing. Even if you are wearing a wrist strap, your body is grounded but your clothes are not.
- Bare board and open housing cameras: use a special ESD housing.

Cable connections

Micro USB 3.0 ports are intended for use in office applications. The USB3 Vision Standard enhances the USB 3.0 Standard by adding a screw-locking mechanism to better suit industrial applications. We recommend using only screw-lock USB cables to avoid damage to cameras, enhancing the durability and performance of cameras, and ensuring a seamless experience.

- Fasten screw-lock connectors before you start camera operation.
- Provide sufficient strain relief for all cable connections to avoid camera damage.
- Use only shielded cables to avoid electromagnetic interference.



Compatible USB 3.0 cables

For USB 3.0 interface cables, industrial grade, with screw locks, Standard-A to Micro-B, see www.alliedvision.com/en/products/accessories.

PCBAs

Alvium USB cameras enable access to PCBAs. Keep away from camera electronics to avoid damage.

Camera power



Alvium USB Flex cameras

Please apply the contents below depending on the camera connection of your individual application.

Operating the camera beyond the specified range damages the camera.

Standard Alvium USB cameras are powered over USB. Alternatively, cameras can be powered using the I/O connector at a maximum input of 5.5 VDC, using a limited power source (LPS), according to IEC 62368-1 with maximum 1.5 A. The camera is not intended to be connected to a DC distribution network.

- Make sure that USB 3.0 or 3.1 Gen 1 host controller cards, on-board host controllers, or hubs provide sufficient current supply for the connected cameras.
- Only use power supplies that meet the insulation requirement according to PELV or SELV. For details, please refer to IEC 61140.
- We recommend using powered hubs, especially for multi-camera operation.



Alvium accessories

For suitable USB accessories, see www.alliedvision.com/en/products/accessories.

GPIOs

To avoid damage to the camera, keep maximum input voltage below 5.5 VDC and maximum current below 12 mA per output. See [Specifications](#) on page 72 for details. The maximum length for I/O cables must not exceed 30 meters.

Reverse polarity

If Alvium USB cameras are externally powered with reverse polarity, the cameras can be damaged. See [I/O connector pin assignment](#) on page 291 for proper external power connections.

JST-cables

JST I/O cables without shielding are designed to be used with bare board or open housing Alvium cameras. The customer is responsible for an EMC compliant design. For applications without an additional EMC housing, please use shielded JST I/O cables with screw lock.

Ground loops

Unsuitable connections can lead to different potentials between the camera system GND and the environmental shield/chassis GND caused by ground loops. This can damage the camera and the connected devices or cause malfunctions.

- Avoid potential differences between the camera housing and GND.
- All wiring must be done by authorized personnel, according to the corresponding technical standards.
- You may mount the camera electrically isolated.
- Read the Avoiding Ground Loops in Vision Systems application note.



More information

See the Avoiding Ground Loops in Vision Systems application note at www.alliedvision.com/en/support/technical-documentation/alvium-usb-documentation.

Hirose DF40C-50DP-0.4V connectors

Hirose DF40C-50DP-0.4V board-to-board connectors enable compact camera design.

The small-sized connectors are sensitive to mechanical stress and are specified for maximum 20 mating and unmating cycles. Especially if you are inexperienced with these connectors, be very cautious. If these connectors are broken, cameras must be replaced. To install and operate cameras safely, read this section carefully.



Additional information

For technical data and more instructions on the Hirose connectors, see the manufacturer data sheet at www.hirose.com.

USB connections

USB 3.0 and 3.1 Gen 1 host controllers and hubs

To avoid damage to USB 3.0 or 3.1 Gen 1 host controller cards or hubs, make sure these components provide sufficient current supply for the connected cameras. For suitable USB 3.0 accessories, see www.alliedvision.com/en/products/accessories.

If suddenly your camera is not recognized anymore, check for a crashed USB hub. Disconnect the USB and power supply cable from the hub. Reconnect both.

USB cables

Proper cable handling enables reliable performance:

- Use only shielded cables to avoid electromagnetic interferences.
- Please use cables recommended by Allied Vision.
- Avoid unnecessary bending to prevent damage to the cables.
- Avoid coiling to prevent electromagnetic interference.

Alvium USB cameras and USB 2.0

If Alvium USB cameras are connected to USB 2.0 ports, they are recognized. They can be operated with reduced performance only if `DeviceLinkThroughputLimit` is set to a value supported by USB 2.0. See [Host setup and bandwidth](#) on page 320. Some pixel formats may not be supported.



No image transfer at high bandwidths

USB 2.0 supports maximum 50 MByte/s. If cameras require a higher bandwidth than 50 MByte/s for streaming, no image is transferred on a USB 2.0 bus. The bandwidth used by a camera results from `DeviceLinkThroughputLimit`, the image resolution, sensor characteristics, and pixel format (Mono8 has 8 bits per pixel, while RGB8 has 3 × 8 bits per pixel).

Handling bare board cameras

Bare board cameras are an electronic assembly without a protective housing. To avoid damage:

- Handle bare board cameras with extreme care.
- Avoid any mechanical stress to the sensor area.
- Avoid short circuits by keeping away from electronics components.

Observe for mounting bare board cameras:

- Allow mechanical contact only at the mounting area. (This does not apply to the cooling area.)
- Enable proper cooling at the cooling area, see [Mounting bare board cameras](#) on page 273.
- Give 2 mm minimum clearance above board components.
- Tighten screws at 0.1 Nm maximum torque.
- Follow the instructions in [Mounting bare board cameras](#) on page 273.

Optical components

Provide the following conditions to keep dirt and droplets out of the optical system of camera and lens:

- Dust-free environment
- Low relative humidity
- No condensation.

When camera or lens are stored:

- Cover the lens mount with a protection foil or cap.
- Cover front and back lens with caps.



Damage to optical components by conductive media for heat sinks

See [Conductive media for heat sinks](#) on page 71 for details.

Sensor

Sensors are sensitive to excessive radiation: focused sunlight, UV light, lasers, and X-rays can damage the sensor. Dirt and scratches can damage the sensor as well. Alviium USB cameras do not need additional cleaning. Cameras are cleaned before shipping. Incorrect cleaning can damage the sensor or the filter. Therefore, never clean the sensor or the filter.

Protect the camera filter and the sensor from dirt, because dirt becomes more visible the closer it gets to the sensor. In addition, keep the back lens clean. Hold the camera with the lens mount facing the ground to keep dirt out of the lens mount as shown in [Figure 8](#) on page 69.

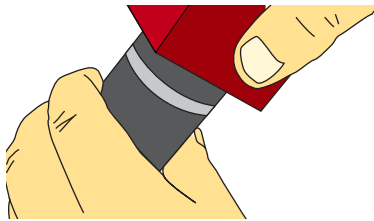

Figure 8: Holding the camera with the lens mount facing the ground

When no lens is mounted, protect the sensor and filter by a dust cap.

Possible damage to image sensors due to electrostatic discharge

Generally, bare board cameras and cameras with incomplete housings are very sensitive to electrostatic discharge (ESD) as electronics components are not protected.

In some rare cases, electrostatic charge occurring on the surface of the image sensor may cause damages to particular pixel groups, which may become visible as bubbles or blobs in the image generated by the sensor.

Therefore, it is very important to comply with ESD protection measures in accordance with technical standards.

Follow the instructions in [ESD](#) on page 65.

Sensor cleanliness

Definitions for Alviium cameras are shown in [Table 8](#). The incident beam is not related to the lens' angle of view.

Sensor family	Aperture*	Incident beam	Visible particles quantity
e2v	f1/4.0	≥14°	0
ON Semi	f1/4.0	≥14°	0
Sony	f1/8.0	≥7°	0

Table 8: Sensor cleanliness definitions

Alvium cameras are manufactured to match the requirements of typical machine vision applications. This enables a clean image for typical monitor view. Particles may become visible when the image is viewed critically, such as with contrast enhancement or edge detection.

This applies to standard Alvium cameras with lens mount: C-Mount, CS-Mount, or S-Mount (also known as M12).

But not to additional hardware options: Bare Board, Frame, or Flex. Sensors with RCG (Removed Cover Glass) and TCG (Taped Cover Glass), come with a tape attached by the sensor manufacturer and are not optimized for cleanliness by Allied Vision.



Optical cleaning at Allied Vision

Before being shipped, each camera is tested for cleanliness in order to meet the requirements of machine vision applications. For more information, see the Optical Cleaning for Allied Vision Cameras competence showcase document at www.alliedvision.com/en/support/technical-documentation/alvium-usb-documentation.



Advanced sensor cleanliness

If definitions for **standard Alvium cameras with lens mount** do not fulfill the requirements of your application, please contact your Allied Vision Sales representative or visit www.alliedvision.com/en/about-us/contact-us/technical-support-repair-/rma.

Lenses

Maximum protrusion

The sensor, filter, lens, or camera electronics can be damaged if an object (typically a lens) exceeding maximum protrusion is mounted to the camera. Use lenses with a maximum protrusion within camera specifications.

Figure 9 shows maximum protrusion. For details, see [Maximum protrusion for front mounts](#) on page 243.

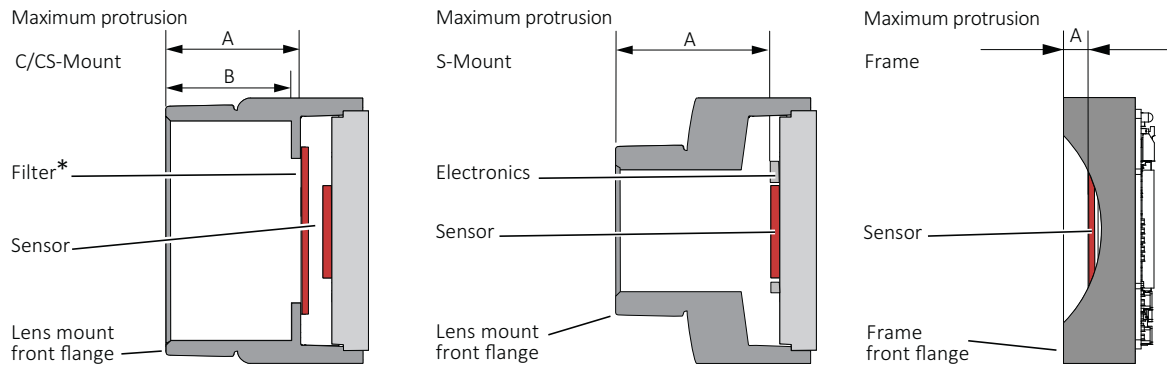

*Only color models are equipped with an IR cut filter

Figure 9: Maximum protrusion CS-Mount and C-Mount, S-Mount, Frame

For S-Mount lenses, read [Mounting and focusing S-Mount lenses](#) on page 280 to avoid damage to the sensor, the electronics, and lens.

Mechanical components

Heat sinks

Heat sinks can be used to cool the camera for safety and to improve image quality. Adhere to the instructions provided by the manufacturer of the heat sink.

Conductive media for heat sinks

Some conductive media for heat sinks contain corrosive substances that can damage optical surfaces of the sensor, filter, and lens.

- Cover the optical path of the camera when you apply heat sink compound or adhesive to prevent substances and fumes from damaging optical surfaces.
- Adhere to the instructions and safety notes provided by the manufacturer of the conductive media.
- Ensure that the conductive media is correctly positioned: covering only the **cooling area**, see [Mounting the heat sink](#) on page 272.

BIOS drivers

Sometimes, USB component's firmware must be updated before operation, including devices, such as host adapters cards. To avoid damage and to benefit from possible updates to increase performance: Check for BIOS updates related to USB.

Specifications



This chapter includes:

Applied standards	73
Notes on specifications.....	76
Alvium 1800 U model specifications	86
White balance default.....	217
Standard Alvium: Dimensions and mass	218
Standard Alvium: Technical drawings	220
Alvium Flex: Dimensions and mass.....	235
Alvium Flex: Technical drawings	236
Alvium Frame: Dimensions and mass.....	240
Alvium Frame: Technical drawings.....	240
Alvium Frame Flex: Dimensions and mass	241
Alvium Frame Flex: Technical drawings	242
Maximum protrusion for front mounts	243
IR cut filter	244
Sensor position accuracy	245
User sets.....	248
Camera feature availability	249

Applied standards

GenICam

GenICam provides a generic access for cameras and devices that is independent of the interface. This enables operating cameras with USB3 Vision, GigE Vision, or CoaXPress interfaces with a common software.

GenICam consists of multiple modules for different tasks. Allied Vision cameras and software use these modules, like the SFNC that standardizes feature names and types via an XML file or the transport layer interface (GenTL) used to grab images.

Alvium 1800 U cameras comply to:

- USB3 Vision Standard Version 1.1
- GenICam Standard Document Version 2.1.1
- GenAPI Schema Version 1.1
- GenAPI Version 3.1
- GenICam Standard Features Naming Convention (SFNC) Version 2.7
- GenICam Pixel Format Naming Convention (PFNC) Version 2.2

USB3 Vision 1.1

USB3 Vision standard for cameras and imaging products is based on USB 3.0 standard, using USB 3.0 ports. It provides control over compliant devices by GenICam Applications Programming Interface (API). USB3 Vision standard is administered by the Automated Imaging Association (AIA).

IP class

The following statement applies to closed housing cameras only. Equipped with a lens as intended, the Alvium USB closed housing camera complies with IP30 class according to IEC 60529.

Shock and vibration



Alvium USB Flex and Frame cameras

Shock and vibration tests were done only for standard Alvium USB closed and open housing cameras. Please do your own testing for Alvium Flex or Frame cameras, depending on the individual setup.

Alvium USB closed and open housing cameras were tested according to the following standards:

- IEC 60068-2-6, sinusoidal vibration testing
- IEC 60068-2-27, shock testing
- IEC 60068-2-64, random vibration testing.

Cameras were inspected before and after the tests. All tests were passed successfully:

Condition	Passed
Mechanics	<ul style="list-style-type: none"> • The camera housings showed no deformations. • The connections between camera components had not come loose. • The sensor position was within the specified tolerances of a new camera.
Camera behavior	Camera functionalities were not affected, no deviations occurred.
Image streaming	Images were streamed without errors.

Table 9: Conditions for passed tests

The conditions for cameras and lenses were the same for all tests. Solid aluminum tubes were used to represent real lenses:

Parameter	Value
Lens dummy length	38 mm
Lens dummy mass	70 g
Center of gravity (CoG) ¹	20 mm

¹ For camera and lens dummy assemblies, measured from the lens mount front flange

Table 10: Conditions for lenses

IEC 60068-2-6: Sinusoidal vibration

Frequency	Acceleration	Displacement
10 Hz to 58.1 Hz	Not applicable	1.5 mm
58.1 Hz to 500 Hz	20 g ⁽¹⁾	Not applicable

¹ g = Gravity of earth

Table 11: Frequency, acceleration, and displacement for IEC 60068-2-6 tests

Parameter	Value
Axis	x, y, z
Sweep rate	1 oct/min
Sweep duration per axis [hh:mm:ss]	00:11:17
Number of sweeps	20

Table 12: Other parameters for IEC 60068-2-6 tests

IEC 60068-2-27: Shock

Parameter	Value
Axis	x, y, z
Acceleration	20 g ⁽¹⁾
Number of shocks per axis	10
Duration per axis	11 ms
Waveform	Half sine
¹ g = Gravity of earth	

Table 13: Parameters for IEC 60068-2-27 tests

IEC 60068-2-64: Random vibration

Frequency	Acceleration ¹
15 Hz to 500 Hz	0.05 g ² /Hz
¹ g = Gravity of earth	

Table 14: Frequency and acceleration for IEC 60068-2-64 tests

Parameter	Value
Axis	x, y, z
Acceleration RMS (Sigma)	4.9 g ⁽¹⁾
Acceleration peak (Sigma)	14.8 g ⁽¹⁾
Duration per axis [hh:mm:ss]	00:30:00
¹ g = Gravity of earth	

Table 15: Other parameters for IEC 60068-2-64 tests

Notes on specifications

This section defines the conditions for specifications stated in this chapter.

Sensor

Measurements for QE and spectral response

Curves for quantum efficiency and for relative response show manufacturer data that has been adapted by Allied Vision's measurements according to EMVA 1288. In some cases, no such measurements may be available. This is signaled by table captions saying **According to manufacturer data**. Please feel free to ask your Allied Vision Sales representative if you have any questions.

Absolute QE plots

Measurements for color cameras were done with IR cut filter, measurements for monochrome and S-Mount cameras were done without optical filters. With optical filters, QE decreases by approximately 10%. The uncertainty in measurement of the QE values is $\pm 10\%$. This is mainly due to uncertainties in the measuring apparatus itself (such as Ulbricht sphere and optometer).

Manufacturing tolerance of the sensor increases overall uncertainty.

ON Semiconductor sensors

The curve in the absolute QE plots shown in this chapter is from the sensor manufacturer data sheet. The information was correct at the time of publishing.

Sony sensors

Sony provides relative response curves in their sensor data sheets. To create the absolute QE plots shown in this chapter, the relative response was converted to a normalized QE response and then adjusted as per three measured QE values (at 448 nm, 529 nm, 632 nm) for color sensors and one measured QE value (at 529 nm) for monochrome sensors.

Wavelength

The wavelength range in the absolute QE plots reflects the information available in the sensor manufacturer data sheet at the time of publishing. For additional wavelength information, contact the sensor manufacturer.

Spectral response plots

The curves in the spectral response plots shown in this chapter were calculated from measured quantum efficiencies at 448 nm, 529 nm, and 632 nm. The shape of the curve is taken from the sensor data sheet but the values have been adjusted based on these measured values. The uncertainty in measurement of the spectral response values is $\pm 10\%$.

Exposure time and frame rates

Specified values

Stated values were calculated (see [Operation for maximum frame rates](#)), then verified with the test setup described in [Table 16](#).

Deviations from stated frame rates can occur, especially when:

- The camera is operated in triggered mode.
- Low bandwidth is used as adjusted by `DeviceLinkThroughputLimit` or when the host connection is limiting the throughput.
- Small ROIs are used.

Component	Property
Desktop workstation	Dell Precision T5500 Precision (EHW400)
Chipset	Intel X5520
CPU	Intel Xeon X5670 (6 cores)
CPU frequency	2.93 GHz
RAM	12 GB
Graphics controller	NVIDIA Quadro FX 580
USB controller	Delock U3 PCIe 1XG205-1S Rev. 1.1 (2-port USB 3.0 to PCI Express x1 Gen 2 with Renesas chipset)
Operating system	Windows 7 Ultimate 64-bit SP1
Measured by	Oscilloscope
Measured signal	<i>ExposureActive</i>

Table 16: Test setup components

Factors for exposure time and frame rates

- The **default bandwidth** for Alvium USB cameras is 200 MByte/s. For some models, you can achieve higher frame rates by increasing values for `MaxTransferSize` and `DeviceLinkThroughputLimit`. See [Host setup and bandwidth](#) on page 320.
- Available values and increments for **exposure time** depend on other controls, such as `DeviceLinkThroughputLimit`. See [Value changes by feature interdependencies](#) on page 315.
- For **delays**, see [Exposure start delay = exposure area – exposure time.](#) on page 303.
- Calculation of maximum **frame rates for different ROIs** for Alvium USB cameras does not allow to give a formula. [Operation for maximum frame rates](#) on page 79 defines the conditions for measuring ROI frame rates.

Sensor ADC readout modes for maximum frame rates

If you are using pixel formats that do not require 12-bit sensor ADC readout and you want to achieve higher frame rates, you can select between readout modes for 12-bit, 10-bit, and 8-bit with some Alvim USB camera models. See your model's specifications.

By default, Alvim 1800 U models use the maximum bit depth for `SensorBitDepth`. For selected models, *Adaptive* mode switches automatically between 12-bit and 10-bit sensor ADC readout, depending on the bit depth of the selected pixel format. This allows to reduce bandwidth and increase frame rates when only 10-bit is required.

To enable the 8-bit sensor readout mode, you must switch manually, using `SensorBitDepth`. Please observe that the image brightness changes when you switch between 8-bit sensor ADC readout mode and the other readout modes.

Keep in mind that changing the output bit depth of the sensor also affects the minimum available exposure time of the camera.



Maximum frame rates at different values for `SensorBitDepth`

When the maximum bandwidth supported by USB interface is reached, reducing the value for `SensorBitDepth` does not increase the available maximum frame rate.

Exposure time behavior regarding `ExposureMode`

This section informs about how exposure time behaves in the different exposure modes.

All Alvim cameras have an exposure time offset. The exposure time offset and the exposure time increment depend on sensor and camera characteristics. Both, the exposure time offset and the exposure time increment, can change if `Width`, `PixelFormat`, or `DeviceLinkThroughputLimit` are changed. See [Value changes by feature interdependencies](#) on page 315.

`ExposureMode = Timed`

For all Alvim cameras, exposure time can be set by `ExposureTime` or `ExposureAuto`. For this, `ExposureMode` is set to *Timed*.

The selected exposure time is extended automatically:

- If the selected exposure time does not match the available increment, the camera automatically extends the exposure time to the next increment.
- The **exposure time offset is included** in the selected exposure time.

`ExposureMode = TriggerWidth or TriggerControlled`

In addition, most global shutter (GS) cameras can control exposure time by the trigger signal, with the `ExposureMode` set to *TriggerWidth* or *TriggerControlled* (using `ExposureStart` and `ExposureStop`).

The trigger controlled exposure time is extended automatically:

- If the trigger controlled exposure time does not match the available increment, the camera automatically extends the exposure time to the next increment.
- Subsequently, the **exposure time offset is added**.

You can use *ExposureActive* to determine the duration of the exposure time offset.

Operation for maximum frame rates

Values for maximum frame rates and for minimum and maximum exposure time in the specification tables are based on following parameters:

- Factory settings (camera after power up)
- Minimum exposure time
- Full resolution
- Mono8 pixel format or 8-Bit Bayer pixel format
- Camera operation in freerun mode
- Minimum value for *SensorBitDepth* (8-bit sensor ADC readout mode if available)
- Bandwidth required for the corresponding frame rate, as stated in the tables for ROI frame rates.

Bandwidth: Values were measured for 200 MByte/s, 375 MByte/s, 450 MByte/s (set by *DeviceLinkThroughputLimit*), using 8-bit, 10-bit, and 12-bit sensor ADC readout modes, depending on model abilities.

The default value for *DeviceLinkThroughputLimit* is 200 MByte/s for Alvim 1800 U cameras measured as average sensor readout. Observe that data overhead of the USB connection and on the host are included in this value. See [Factors for exposure time and frame rates](#) on page 77.

Frame rates with rolling shutter sensors

The following table shows how the shutter mode impacts available frame rates. Reducing the area for ROI reduces readout time. The values in [Table 17](#) apply only if exposure time is shorter than readout time.

Sensor type	Shutter mode	Trigger mode	Frame rates at full resolution ¹	ROI frame rates
All models, except for...	Global shutter (GS)	Freerun	100%	Increased values
	Global shutter (GS)	External trigger	100%	
1800 U-500, -501 NIR	Rolling shutter (RS)	Freerun	100%	Increased values
	Rolling shutter (RS)	External trigger	>50%	

Table 17: Frame rates depending on shutter and trigger modes (sheet 1 of 2)

Sensor type	Shutter mode	Trigger mode	Frame rates at full resolution ¹	ROI frame rates
1800 U-1240	Rolling shutter (RS)	Freerun	100%	No increase
	Rolling shutter (RS)	External trigger	>99% ⁽²⁾ >50% ⁽³⁾	
	Global reset shutter (GRS)	Freerun	>99%	
	Global reset shutter (GRS)	External trigger	>99% ⁽²⁾ >50% ⁽³⁾	
1800 U-2050	Rolling shutter (RS)	Freerun	100%	Increased values
	Rolling shutter (RS)	External trigger	>99% ⁽²⁾ >50% ⁽³⁾	
	Global reset shutter (GRS)	Freerun	>99%	
	Global reset shutter (GRS)	External trigger	>99% ⁽²⁾ >50% ⁽³⁾	

¹ Related to the values for maximum frame rates stated in the specification tables for each model.

² Monochrome models | ³ Color models

Table 17: Frame rates depending on shutter and trigger modes (sheet 2 of 2)



Achieved frame rates may not match specified values

- Some sensors have an exposure start jitter that may reduce maximum frame rates.
- Your individual setup may cause delays in data transmission.



Bandwidth adjustments

Consider the bandwidth available for camera payload depends on your individual hardware, the operating system, software and drivers, and your application. We recommend you to adjust `DeviceLinkThroughputLimit` and `MaxTransferSize` to the capabilities of your operating system. See [Host setup and bandwidth](#) on page 320.



Interdependencies between ROI and ExposureTime values

Changing parameters for ROI can affect values for `ExposureTime`, such as minimum, maximum, and increments, but `ExposureTime` itself as well. We recommend you to set:

- ROI values
- `DeviceLinkThroughputLimit` before you set values for `ExposureTime`.

See [Value changes by feature interdependencies](#) on page 315 for details.

`MaxTransferSize` can have an impact as well.

Sensor shutter types

Differences between global shutter (GS), rolling shutter (RS), and global reset shutter (GRS) sensors are explained in [Shutter types affecting image readout](#) on page 319. Triggering behavior differs between cameras with global shutter (GS) and rolling shutter (RS). See [Triggering and timings](#) on page 301 for details.

Brightness with 1800 U-812 UV cameras

When the sensor is exposed to light above 400 nm wavelength, the PLS (parasitic light sensitivity) effect occurs: The brightness level increases from the bottom to the top of the image.

Digital binning

Alvium USB cameras combine digital horizontal binning and digital vertical binning, for integer values 1 to 8.



Alvium models \geq 12 MP resolution

If digital horizontal and digital vertical binning are set to 1 \times and the digital vertical binning value is increased, digital horizontal binning is automatically set to 2 \times .

Sensor binning

Selected camera models support sensor binning in addition to digital binning. From these models, all support *Sum* for binning, some also support *Average*.

See the specifications tables in [Alvium 1800 U model specifications](#) on page 86.



Please observe

- Only digital binning or sensor binning can be used at a time.
- You must revert binning values to **1** before you can switch between these binning modes.

Multiple regions

All Alvium 1800 U models support single ROI (region of interest).

In `SubRegionSelector`, `Region0` is enabled for all camera models.

`Region0` cannot be disabled.

Because multiple ROI (`MultipleRegions` features) are sensor based, it is not supported by all camera models. For cameras supporting more than one region, `Region0` to `Region3` can be enabled. With all the corresponding models, `Free` mode is available for `MultipleRegionArrangement` with 1 to 4 subregions. Other models also support `Tile` mode, some models also support `Horizontal` and `Vertical` mode with 1 to 4 subregions. See [Table 18](#).





Mode	Sensor input	Camera output
<i>Free</i>		
<i>Tile</i>		
<i>Horizontal</i>		

Table 18: Modes for `MultipleRegions` (sheet 1 of 2)

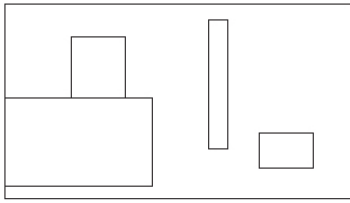

Mode	Sensor input	Camera output
<i>Vertical</i>		

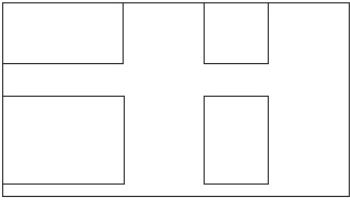
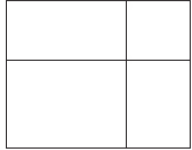
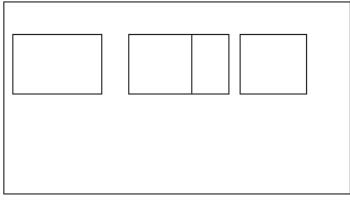
Table 18: Modes for MultipleRegions (sheet 2 of 2)

See the specifications tables in [Alvium 1800 U model specifications](#) on page 86 for **MultipleRegionArrangement** options and [Available subregion resolutions](#) on page 83.

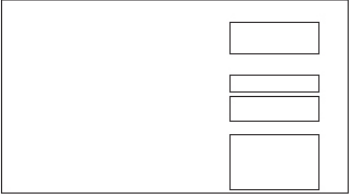

Using multiple regions

Alvium Features Reference: www.alliedvision.com/en/support/technical-documentation/alvium-usb-documentation.

Available subregion resolutions

Table 19 shows the available total pixel resolutions when multiple regions are enabled. How are these values applied?

Alvium 1800 U-2460 supports 1 to 4 subregions in *Horizontal* mode.

Example

Subregions could be 608×8 , 608×8 , 2048×8 , and 1920×8 , with a minimum width of 608 pixels per subregion and a minimum height of 8 pixels.



Minimum width for subregions

We are working on a future solution to enable smaller width values.

The same working principle applies to *Vertical* mode correspondingly.

Alvium model	Sensor	Minimum subregion	Maximum subregion
1800 U-030 VSWIR	IMX991	8×8	656×520
1800 U-040	IMX287	260×4	728×544
1800 U-050	PYTHON 480	Not supported	
1800 U-052	IMX426	Not supported	
1800 U-120	AR0135	Not supported	
1800 U-130 VSWIR	IMX990	8×8	1296×1032

Table 19: Available subregion resolutions (sheet 1 of 2)

Alvium model	Sensor	Minimum subregion	Maximum subregion
1800 U-131	EV76C560	Not supported	
1800 U-158	IMX273	260 × 4	1456 × 1088
1800 U-192	EV76C570	Not supported	
1800 U-203	IMX422	16 × 8	1632 × 1248
1800 U-234	IMX249	92 × 2	1936 × 1216
1800 U-235	IMX17	92 × 2	1936 × 1216
1800 U-240	IMX392	260 × 4	1936 × 1216
1800 U-291	IMX421	16 × 8	1944 × 1472
1800 U-319	IMX265	260 × 4	2064 × 1544
1800 U-320 VSWIR	IMX993	16 × 8	2080 × 1544
1800 U-500	AR0521	Not supported	
1800 U-501 NIR	AR0522	Not supported	
1800 U-507 ¹	IMX264	260 × 4	2464 × 2056
1800 U-508 ¹	IMX250	260 × 4	2464 × 2056
1800 U-510	IMX548	608 × 8	2464 × 2064
1800 U-511	IMX547	608 × 8	2464 × 2064
1800 U-530 VSWIR	IMX992	16 × 8	2592 × 2056
1800 U-811	IMX546	608 × 8	2848 × 2848
1800 U-812 UV	IMX487	608 × 16	2848 × 2848
1800 U-895	IMX267	260 × 4	4112 × 2176
1800 U-1236	IMX304	260 × 4	4112 × 3008
1800 U-1240	IMX226	Not supported	
1800 U-1242	IMX545	608 × 8	4128 × 3008
1800 U-1620	IMX542	608 × 8	5328 × 3040
1800 U-2040	IMX541	608 × 8	4512 × 4512
1800 U-2050	IMX183	Not supported	
1800 U-2460	IMX540	608 × 8	5328 × 4608

¹ Including Pol models

Table 19: Available subregion resolutions (sheet 2 of 2)

Operation for medium power consumption

Values for power consumption in the specification tables are based on following parameters:

- Factory settings (camera after power up)
- Minimum exposure time
- Maximum frame rate
- Full resolution
- Mono8 pixel format or 8-Bit Bayer pixel format
- Camera operation in freerun mode
- Sensor ADC readout using maximum bit depth
- Without bandwidth limitations.

Dimensions and mass

For your model's dimensions, see [Standard Alvium: Dimensions and mass](#) on page 218.

In manufacturing, camera board and sensor are moved against each other to adjust flange focal distance. The value range for camera length with open housing cameras reflects in the technical drawings. See [Standard Alvium: Technical drawings](#) on page 220.

Alvium 1800 U model specifications

Alvium 1800 U-030 VSWIR



Heat affecting your application

Image noise is increased by high operating temperatures, especially with Alvium VSWIR models. Therefore, we recommend you to optimize your SWIR application for heat dissipation. For more information on heat dissipation, see the Heat Dissipation for Housed Alvium CSI-2, USB, and G1 Cameras application note at www.alliedvision.com/en/support/technical-documentation/alvium-usb-documentation.

Feature	Specification
	1800 U-030 VSWIR
Sensor model	Sony IMX991
Resolution	656 (H) × 520 (V); 0.3 MP
Sensor type	InGaAs
Shutter type	Global shutter (GS)
Sensor size	Type 1/4; 3.3 mm × 2.6 mm; 4.1 mm diagonal
Pixel size	5 μm × 5 μm
CRA	0 deg
Sensor bit depth (ADC)	8-bit, 10-bit, 12-bit; Adaptive (10-bit, 12-bit)
Monochrome pixel formats	Mono8 (default), Mono10, Mono10p, Mono12, Mono12p
Maximum frame rate	249 fps (at ≥200 MByte/s)
Exposure time	15 μs to 10 s (200 MByte/s)
Exposure modes	Timed, TriggerControlled, TriggerWidth
Gain	0 dB to 42 dB; 0.1 dB increments
Digital binning	Horizontal: 1 to 8 columns; Vertical: 1 to 8 rows
Multiple ROI (H × V)	<i>Free Tile Horizontal: 1 × 1 to 4 × 1 Vertical: 1 × 1 to 1 × 4</i>
Image buffer (RAM)	256 KByte
Non-volatile memory (Flash)	1024 KByte
GPIOs	4 programmable GPIOs As direct inputs (push-pull): 0 to 5.5 VDC As direct outputs (push-pull): 0 to 3.3 VDC at 12 mA
Power requirements	Power over USB; External power
Power consumption (typical, at 5 VDC)	USB power: 2.0 W External power: 2.2 W
Storage temperature	-20 °C to +85 °C ambient temperature

Table 20: Alvium 1800 U-030 VSWIR specifications (sheet 1 of 2)

Feature	Specification			
	1800 U-030 VSWIR			
	Hardware option	Housing	Cooling area ¹	Mainboard ²
Operating temperature	Bare board ³	Not applicable	-20 °C to +85 °C	-20 °C to +85 °C
	Open housing ⁴	-20 °C to +65 °C	-20 °C to +85 °C	
	Closed housing	-20 °C to +65 °C	Not applicable	
Relative humidity	0% to 80% (non-condensing)			
Digital interface	Micro-B USB 3.1 Gen 1 interface			
Camera controls	GenICam (GenICam Access)			

¹ See [Mounting the heat sink](#) on page 272.

² Output by `DeviceTemperature`

³ Ensure that the sensor is operated in the temperature range specified by the manufacturer. For any questions, please visit www.alliedvision.com/en/support.

⁴ Temperature values must be observed for the housing **and** for the cooling area.

Table 20: Alvium 1800 U-030 VSWIR specifications (sheet 2 of 2)

Absolute QE

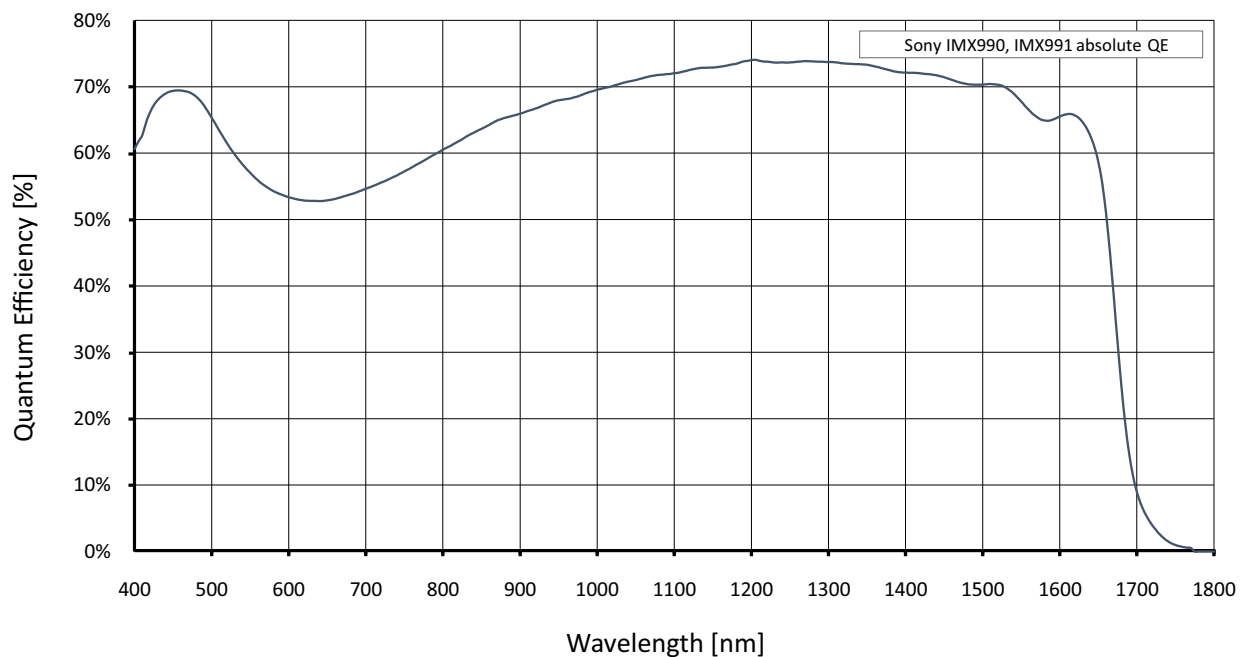

Figure 10: Alvium 1800 U-030 VSWIR (Sony IMX991) absolute QE

ROI frame rates

Values are based on the conditions defined in [Specified values](#) on page 77.

To reach the maximum frame rate available for this setup, the bandwidth for image traffic is 200 MByte/s. Increasing the `DeviceLinkThroughputLimit` value does not increase frame rates.

Image format	Width [pixels]	Height [pixels]	ROI area [MP]	Frame rate [fps] ¹		
				450 MByte/s	375 MByte/s	200 MByte/s
Full resolution	656	520	0.341	249.2/231.0/133.0		
VGA	640	480	0.307	267.9/248.3/143.0		
HVGA	480	320	0.154	384.9/356.4/205.2		
QVGA	320	240	0.077	494.1/457.2/262.7		
HQVGA	240	160	0.038	683.2/634.4/365.0		
QQVGA	160	120	0.019	849.9/789.2/454.6		
Max. × half	656	260	0.171	450.4/416.9/241.0		
Max. × min.	656	8	0.005	2340.8/2138.5/1286.8		
Min. × max.	8	520	0.004	252.3/234.3/134.1		
Min. × min.	8	8	64 Px	2644.2/2455.3/1405.9		

¹ Mono8 at `SensorBitDepth` = 8-Bit⁽²⁾ / Mono10 at `SensorBitDepth` = 10-Bit / Mono12 or at `SensorBitDepth` = 12-Bit

² The `SensorBitDepth` value must be set separately from `PixelFormat`. See [Sensor ADC readout modes for maximum frame rates](#) on page 77 for details.

Table 21: Alvium 1800 U-030 VSWIR ROI frame rates

Alvium 1800 U-040m/c

Feature	Specification	
	1800 U-040m (monochrome)	1800 U-040c (color)
Sensor model	Sony IMX287	
Resolution	728 (H) × 544 (V); 0.4 MP	
Sensor type	CMOS	
Shutter type	Global shutter (GS)	
Sensor size	Type 1/2.9; 5.0 mm × 3.8 mm; 6.3 mm diagonal	
Pixel size	6.9 μm × 6.9 μm	
CRA	0 deg	
Sensor bit depth (ADC)	8-bit, 10-bit, 12-bit; Adaptive (10-bit, 12-bit)	
Monochrome pixel formats	Mono8 (default), Mono10, Mono10p, Mono12, Mono12p	Mono8, Mono10, Mono10p, Mono12, Mono12p
YUV color pixel formats	Not applicable	YCbCr411_8_CbYYCrYY, YCbCr422_8_CbYCrY, YCbCr8_CbYCr
RGB color pixel formats	Not applicable	BGR8, RGB8 (default)
Raw color pixel formats	Not applicable	BayerRG8, BayerRG10, BayerRG10p, BayerRG12, BayerRG12p
Maximum frame rate	494 fps (at ≥375 MByte/s)	
Exposure time	20 μs to 10 s (375 MByte/s)	
Exposure modes	Timed, TriggerControlled, TriggerWidth	
Gain	0 dB to 48 dB; 0.1 dB increments	
Digital binning	Horizontal: 1 to 8 columns; Vertical: 1 to 8 rows	
Multiple ROI (H × V)	<i>Free</i>	
Image buffer (RAM)	256 KByte	
Non-volatile memory (Flash)	1024 KByte	
GPIOs	4 programmable GPIOs As direct inputs (push-pull): 0 to 5.5 VDC As direct outputs (push-pull): 0 to 3.3 VDC at 12 mA	
Power requirements	Power over USB; External power	
Power consumption (typical, at 5 VDC)	USB power: 1.9 W External power: 2.1 W	

Table 22: Alvium 1800 U-040m/c specifications (sheet 1 of 2)

Feature	Specification			
	1800 U-040m/c			
Storage temperature	-20 °C to +85 °C ambient temperature			
Operating temperature	Hardware option	Housing	Cooling area¹	Mainboard²
	Bare board ³	Not applicable	-20 °C to +85 °C	-20 °C to +85 °C
	Open housing ⁴	-20 °C to +65 °C		
	Closed housing	-20 °C to +65 °C	Not applicable	
Relative humidity	0% to 80% (non-condensing)			
Digital interface	Micro-B USB 3.1 Gen 1 interface			
Camera controls	GenICam (GenICam Access)			
¹ See Mounting the heat sink on page 272. ² Output by <code>DeviceTemperature</code> ³ Ensure that the sensor is operated in the temperature range specified by the manufacturer. For any questions, please visit www.alliedvision.com/en/support . ⁴ Temperature values must be observed for the housing and for the cooling area.				

Table 22: Alvium 1800 U-040m/c specifications (sheet 2 of 2)

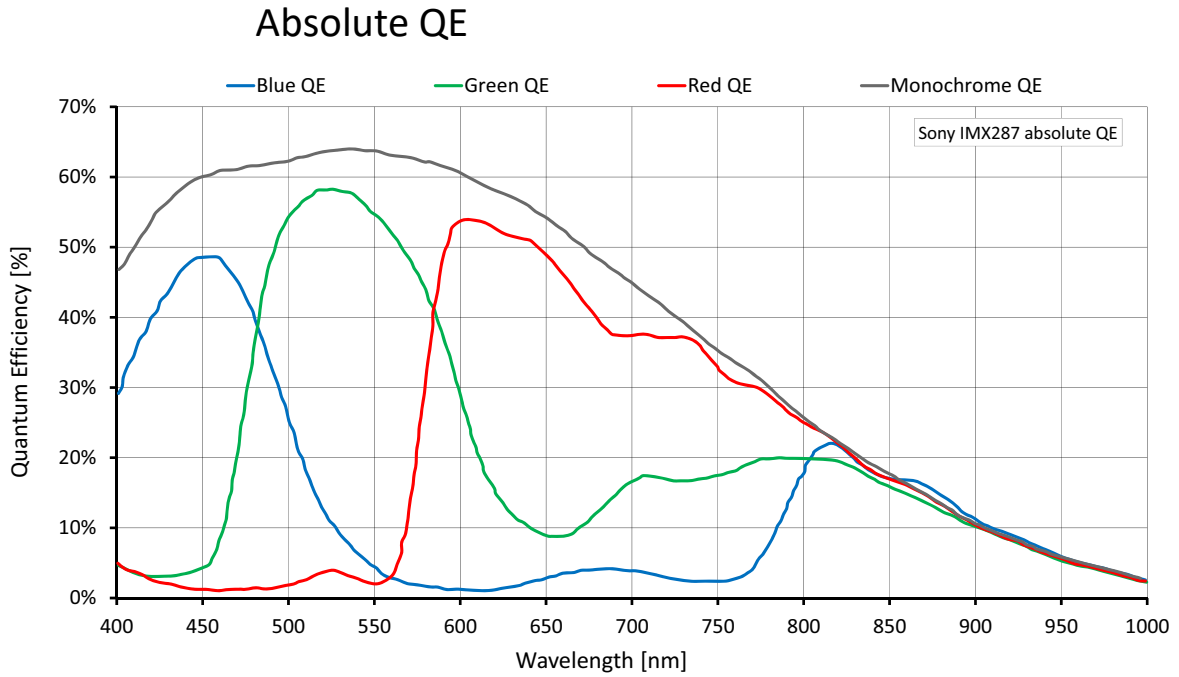

Figure 11: Alviium 1800 U-040m/c (Sony IMX287) absolute QE

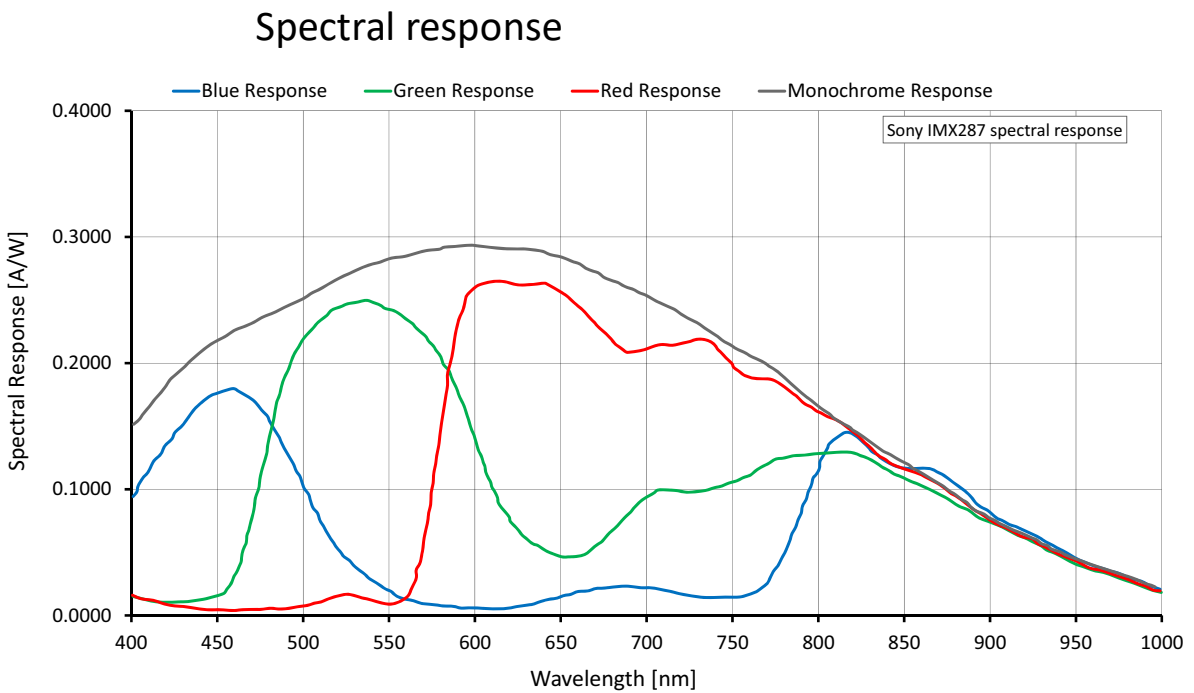

Figure 12: Alviium 1800 U-040m/c (Sony IMX287) spectral response

ROI frame rates

Values are based on the conditions defined in [Specified values](#) on page 77.

To reach the maximum frame rate available for this setup, the bandwidth for image traffic is 375 MByte/s. Increasing the `DeviceLinkThroughputLimit` value does not increase frame rates.

Image format	Width [pixels]	Height [pixels]	ROI area [MP]	Frame rate [fps] ¹		
				450 MByte/s	375 MByte/s	200 MByte/s
Full resolution	728	544	0.396	494.0/409.3/302.3		445.3/227.3/224.0
VGA	640	480	0.307	553.3/458.5/338.9		553.3/288.9/284.9
HVGA	480	320	0.154	786.3/652.1/483.5		786.3/539.9/483.5
QVGA	320	240	0.077	991.2/833.4/617.7		
HQVGA	240	160	0.038	1340.5/1138.9/847.2		
QQVGA	160	120	0.019	1627.3/1390.6/1037.6		
Max. × half	728	272	0.198	884.6/733.8/544.8		800.5/412.9/405.9
Max. × min.	728	8	0.006	3803.8/3186.0/2462.7		3545.1/1992.7/ 1915.3
Min. × max.	8	544	0.004	498.0/416.0/306.8		
Min. × min.	8	8	64 Px	4057.3/3647.7/2798.5		

¹ Mono8 or Bayer...8⁽²⁾ at `SensorBitDepth` = 8-Bit⁽³⁾ /
 Mono10 or Bayer...10 at `SensorBitDepth` = 10-Bit /
 Mono12 or Bayer...12 at `SensorBitDepth` = 12-Bit

² The three dots... represent the colors of a Bayer pixel format, such as in BayerRG8.

³ The `SensorBitDepth` value must be set separately from `PixelFormat`.
 See [Sensor ADC readout modes for maximum frame rates](#) on page 77 for details.

Table 23: Alvium 1800 U-040m/c ROI frame rates

Alvium 1800 U-050m/c



Supported firmware version

Alvium 1800 U-050 models are delivered with firmware 00.11.00.9cf0c21e. The firmware version cannot be updated to later versions.

Feature	Specification	
	1800 U-050m (monochrome)	1800 U-050c (color)
Sensor model	ON Semiconductor PYTHON 480	
Resolution	808 (H) × 608 (V); 0.5 MP	
Sensor type	CMOS	
Shutter type	Global shutter (GS)	
Sensor size	Type 1/3.6; 3.9 mm × 2.9 mm; 4.9 mm diagonal	
Pixel size	4.8 μm × 4.8 μm	
CRA	1.65 deg	
Sensor bit depth (ADC)	10-bit	
Monochrome pixel formats	Mono8 (default), Mono10, Mono10p, Mono12, Mono12p	Mono8, Mono10, Mono10p, Mono12, Mono12p
YUV color pixel formats	Not applicable	YCbCr411_8_CbYYCrYY, YCbCr422_8_CbYCrY, YCbCr8_CbYCr
RGB color pixel formats	Not applicable	BGR8, RGB8 (default)
Raw color pixel formats	Not applicable	BayerRG8, BayerRG10, BayerRG10p, BayerGR12, BayerGR12p
Maximum frame rate	117 fps (at ≥200 MByte/s)	
Exposure time	64 μs to 10 s (200 MByte/s)	
Exposure modes	Timed, TriggerControlled, TriggerWidth	
Gain	0 dB to 11.3 dB; 0.1 dB increments	
Digital binning	Horizontal: 1 to 8 columns; Vertical: 1 to 8 rows	
Image buffer (RAM)	256 KByte	
Non-volatile memory (Flash)	1024 KByte	
GPIOs	4 programmable GPIOs As direct inputs (push-pull): 0 to 5.5 VDC As direct outputs (push-pull): 0 to 3.3 VDC at 12 mA	
Power requirements	Power over USB; External power	
Power consumption (typical, at 5 VDC)	USB power: 1.5 W External power: 1.7 W	

Table 24: Alvium 1800 U-050m/c specifications (sheet 1 of 2)

Feature	Specification			
	1800 U-050m/c			
Storage temperature	-20 °C to +85 °C ambient temperature			
Operating temperature	Hardware option	Housing	Cooling area¹	Mainboard²
	Bare board ³	Not applicable	-20 °C to +85 °C	-20 °C to +85 °C
	Open housing ⁴	-20 °C to +65 °C		
	Closed housing	-20 °C to +65 °C	Not applicable	
Relative humidity	0% to 80% (non-condensing)			
Digital interface	Micro-B USB 3.1 Gen 1 interface			
Camera controls	GenICam (GenICam Access)			
¹ See Mounting the heat sink on page 272. ² Output by <code>DeviceTemperature</code> ³ Ensure that the sensor is operated in the temperature range specified by the manufacturer. For any questions, please visit www.alliedvision.com/en/support . ⁴ Temperature values must be observed for the housing and for the cooling area.				

Table 24: Alvium 1800 U-050m/c specifications (sheet 2 of 2)

Absolute QE

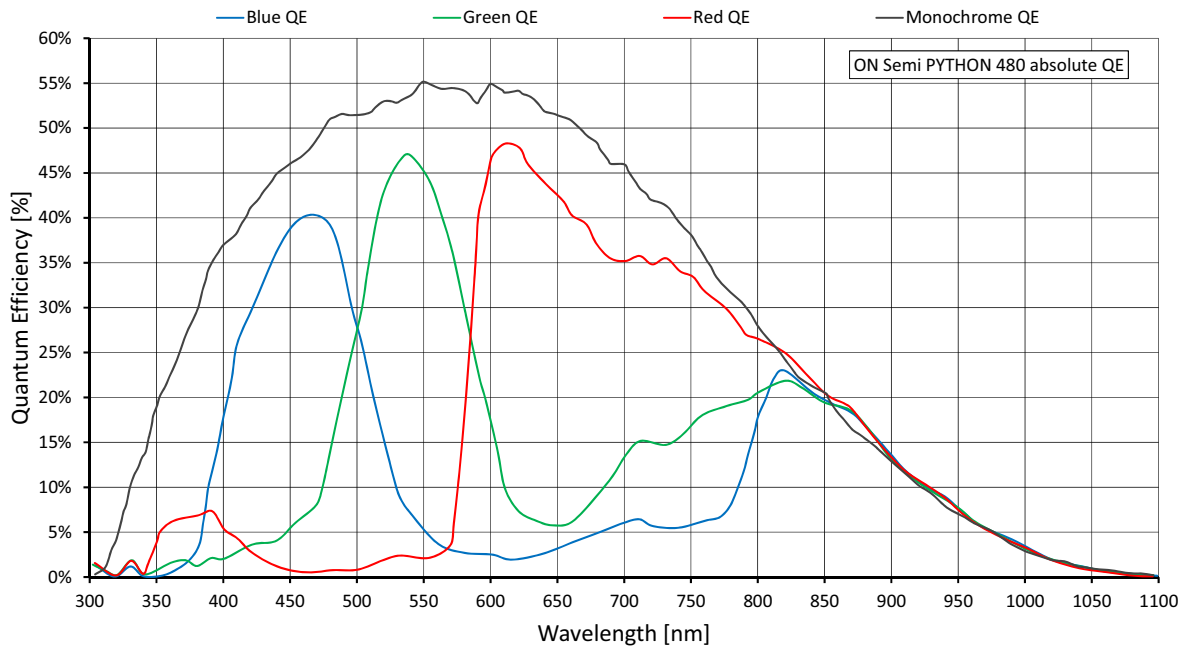

Figure 13: Alvium 1800 U-050m/c (ON Semi PYTHON 480) absolute QE

Spectral response

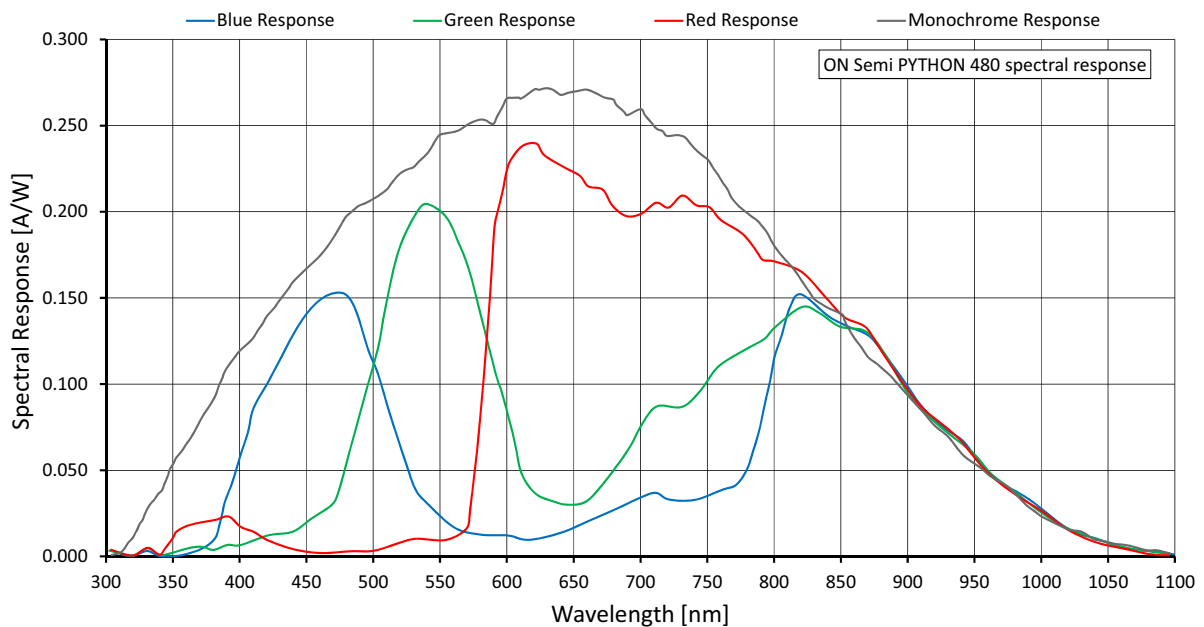

Figure 14: Alvium 1800 U-050m/c (ON Semi PYTHON 480) spectral response

ROI frame rates

Values are based on the conditions defined in [Specified values](#) on page 77.

To reach the maximum frame rate available for this setup, the bandwidth for image traffic is 200 MByte/s. Increasing the `DeviceLinkThroughputLimit` value does not increase frame rates.

Image format	Width [pixels]	Height [pixels]	ROI area [MP]	Frame rate [fps] ¹		
				450 MByte/s	375 MByte/s	200 MByte/s
Full resolution	808	608	0.491	117.2/117.2		
SVGA	800	600	0.480	119.7/119.7		
VGA	640	480	0.307	177.0/177.0		
HVGA	480	320	0.154	314.7/314.7		
QVGA	320	240	0.077	517.2/517.2		
HQVGA	240	160	0.038	792.0/792.0		
QQVGA	160	120	0.019	1083.1/1083.1		
Max. × half	808	304	0.246	220.0/220.0		
Max. × min.	808	8	0.006	1501.7/1501.7		
Min. × max.	8	608	0.005	732.7/732.7		
Min. × min.	8	8	64 Px	2035.8/2035.8		

¹ Mono8 or Bayer...8⁽²⁾ at `SensorBitDepth` = 10-Bit / Mono10 or Bayer...10 at `SensorBitDepth` = 10-Bit

² The three dots... represent the colors of a Bayer pixel format, such as in Bayer**RG8**.

Table 25: Alvim 1800 U-050m/c ROI frame rates

Alvium 1800 U-052m/c

Feature	Specification	
	1800 U-052m (monochrome)	1800 U-052c (color)
Sensor model	Sony IMX426	
Resolution	816 (H) × 624 (V); 0.5 MP	
Sensor type	CMOS	
Shutter type	Global shutter (GS)	
Sensor size	Type 1/1.7; 7.3 mm × 5.6 mm; 9.2 mm diagonal	
Pixel size	9.0 μm × 9.0 μm	
CRA	0 deg	
Sensor bit depth (ADC)	8-bit, 10-bit, 12-bit; Adaptive (10-bit, 12-bit)	
Monochrome pixel formats	Mono8 (default), Mono10, Mono10p, Mono12, Mono12p	Mono8, Mono10, Mono10p, Mono12, Mono12p
YUV color pixel formats	Not applicable	YCbCr411_8_CbYYCrYY, YCbCr422_8_CbYCrY, YCbCr8_CbYCr
RGB color pixel formats	Not applicable	BGR8, RGB8 (default)
Raw color pixel formats	Not applicable	BayerRG8, BayerRG10, BayerRG10p, BayerRG12, BayerRG12p
Maximum frame rate	688 fps (at 450 MByte/s)	
Exposure time	24 μs to 10 s (450 MByte/s)	
Exposure modes	Timed, TriggerControlled, TriggerWidth	
Gain	0 dB to 48 dB; 0.1 dB increments	
Digital binning	Horizontal: 1 to 8 columns; Vertical: 1 to 8 rows	
Multiple ROI (H × V)	<i>Free Tile Horizontal</i> : 1 × 1 to 4 × 1 <i>Vertical</i> : 1 × 1 to 1 × 4	
Image buffer (RAM)	256 KByte	
Non-volatile memory (Flash)	1024 KByte	
GPIOs	4 programmable GPIOs As direct inputs (push-pull): 0 to 5.5 VDC As direct outputs (push-pull): 0 to 3.3 VDC at 12 mA	
Power requirements	Power over USB; External power	
Power consumption (typical, at 5 VDC)	USB power: 4.0 W External power: 4.2 W	

Table 26: Alvium 1800 U-052m/c specifications (sheet 1 of 2)

Feature	Specification			
	1800 U-052m/c			
Storage temperature	-20 °C to +85 °C ambient temperature			
Operating temperature	Hardware option	Housing	Cooling area¹	Mainboard²
	Bare board ³	Not applicable	-20 °C to +85 °C	-20 °C to +85 °C
	Open housing ⁴	-20 °C to +65 °C		
	Closed housing	-20 °C to +65 °C	Not applicable	
Relative humidity	0% to 80% (non-condensing)			
Digital interface	Micro-B USB 3.1 Gen 1 interface			
Camera controls	GenICam (GenICam Access)			
¹ See Mounting the heat sink on page 272. ² Output by <code>DeviceTemperature</code> ³ Ensure that the sensor is operated in the temperature range specified by the manufacturer. For any questions, please visit www.alliedvision.com/en/support . ⁴ Temperature values must be observed for the housing and for the cooling area.				

Table 26: Alvium 1800 U-052m/c specifications (sheet 2 of 2)

Absolute QE

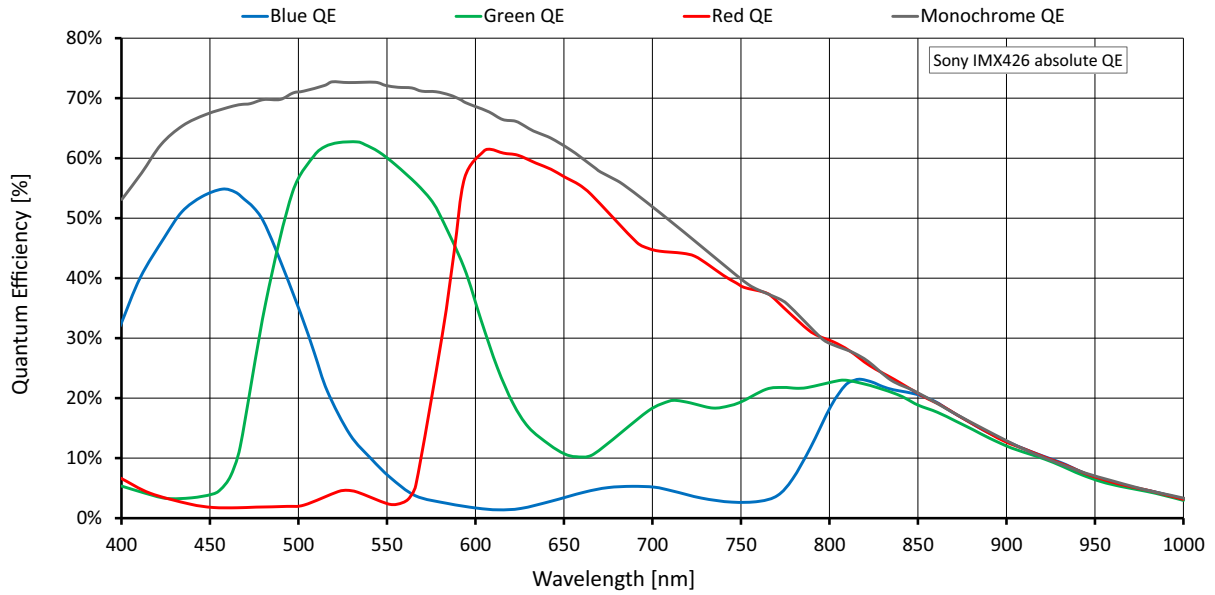

Figure 15: Alvium 1800 U-052m/c (Sony IMX426) absolute QE

Spectral response

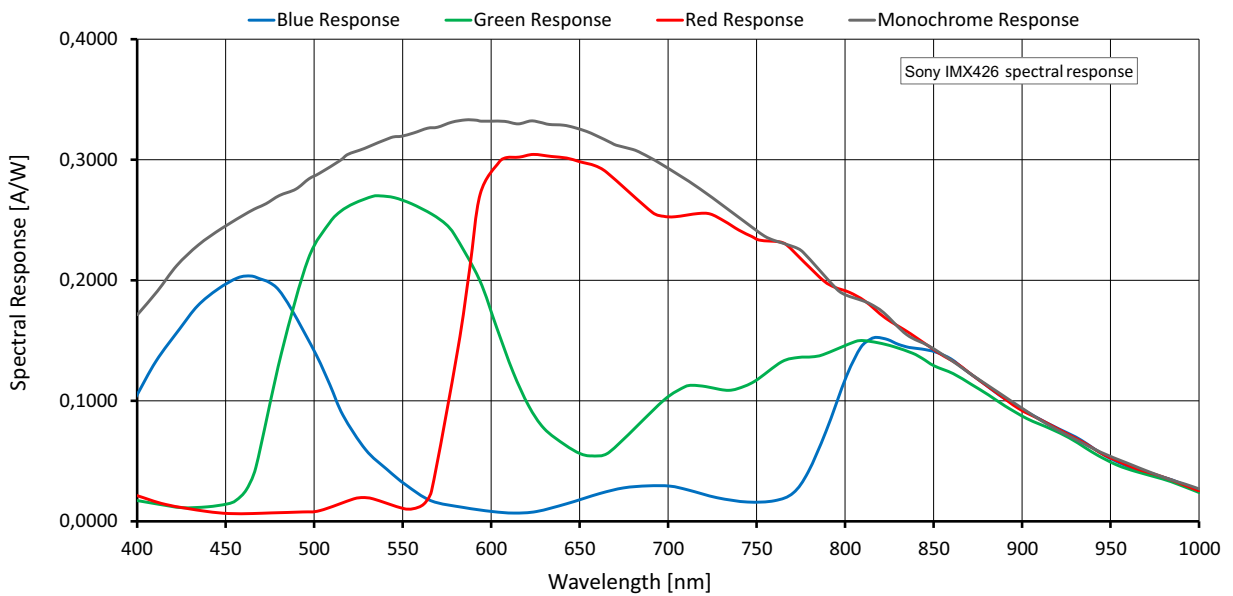

Figure 16: Alvium 1800 U-052m/c (Sony IMX426) spectral response

ROI frame rates

Values are based on the conditions defined in [Specified values](#) on page 77.

To reach the maximum frame rate available for this setup, the bandwidth for image traffic is 450 MByte/s.

Image format	Width [pixels]	Height [pixels]	ROI area [MP]	Frame rate [fps] ¹		
				450 MByte/s	375 MByte/s	200 MByte/s
Full resolution	816	624	0.509	688.5/350.2/354.0	577.5/297.9/303.5	319.7/161.0/165.1
SVGA	800	600	0.48	703.6/364.2/369.6	603.5/309.0/316.0	330.4/168.6/172.2
VGA	640	480	0.307	851.7/548.2/556.2	851.7/465.9/469.5	497.4/255.4/258.7
HVGA	480	320	0.154	1151.8/955.4/849.9	1151.8/836.8/849.9	887.1/455.3/468.7
QVGA	320	240	0.077	1410.7/1171.9/1050.9		1410.7/822.8/854.6
HQVGA	240	160	0.038	1801.8/1500.0/1361.7		1801.8/1379.6/1361.7
QQVGA	160	120	0.019	2044.8/1698.1/1559.3		
Max. x half	816	312	0.255	1116.5/578.2/590.0	943.2/493.4/508.1	531.0/269.3/279.7
Max. x min.	816	8	0.007	2951.1/1656.4/1769.9	2572.4/1436.9/1559.0	1565.7/822.4/914.4
Min. x max.	8	624	0.005	721.2/596.8/524.7		721.2/596.8/524.7
Min. x min.	8	8	64 Px	3664.1/3082.2/2997.8		

¹ Mono8 or Bayer...8⁽²⁾ at **SensorBitDepth** = 8-Bit⁽³⁾ /
 Mono10 or Bayer...10 at **SensorBitDepth** = 10-Bit /
 Mono12 or Bayer...12 at **SensorBitDepth** = 12-Bit

² The three dots... represent the colors of a Bayer pixel format, such as in Bayer**RG8**.

³ The **SensorBitDepth** value must be set separately from **PixelFormat**.
 See [Sensor ADC readout modes for maximum frame rates](#) on page 77 for details.

Table 27: Alvium 1800 U-052m/c ROI frame rates

Alvium 1800 U-120m/c

Feature	Specification	
	1800 U-120m (monochrome)	1800 U-120c (color)
Sensor model	ON Semiconductor AR0135CS	
Resolution	1280 (H) × 960 (V); 1.2 MP	
Sensor type	CMOS	
Shutter type	Global shutter (GS)	
Sensor size	Type 1/3; 4.8 mm × 3.6 mm; 6.0 mm diagonal	
Pixel size	3.75 μm × 3.75 μm	
CRA	0 deg	
Sensor bit depth (ADC)	12-bit	
Monochrome pixel formats	Mono8 (default), Mono10, Mono10p, Mono12, Mono12p	Mono8, Mono10, Mono10p, Mono12, Mono12p
YUV color pixel formats	Not applicable	YCbCr411_8_CbYYCrYY, YCbCr422_8_CbYCrY, YCbCr8_CbYCr
RGB color pixel formats	Not applicable	BGR8, RGB8 (default)
Raw color pixel formats	Not applicable	BayerRG8, BayerRG10, BayerRG10p, BayerRG12, BayerRG12p
Maximum frame rate	52 fps ¹ (at ≥200 MByte/s)	
Exposure time	57 μs to 8 s (200 MByte/s)	
Exposure modes	Timed	
Gain	0 dB to 17.7 dB; 0.1 dB increments	
Digital binning	Horizontal: 1 to 8 columns; Vertical: 1 to 8 rows	
Image buffer (RAM)	256 KByte	
Non-volatile memory (Flash)	1024 KByte	
GPIOs	4 programmable GPIOs As direct inputs (push-pull): 0 to 5.5 VDC As direct outputs (push-pull): 0 to 3.3 VDC at 12 mA	
Power requirements	Power over USB; External power	
Power consumption (typical, at 5 VDC)	USB power: 1.3 W External power: 1.5 W	

¹ In triggered mode, maximum frame rates require minimum exposure times.

Table 28: Alvium 1800 U-120m/c specifications (sheet 1 of 2)

Feature	Specification			
	1800 U-120m/c			
Storage temperature	-20 °C to +85 °C ambient temperature			
Operating temperature	Hardware option	Housing	Cooling area¹	Mainboard²
	Bare board ³	Not applicable	-20 °C to +85 °C	-20 °C to +85 °C
	Open housing ⁴	-20 °C to +65 °C		
	Closed housing	-20 °C to +65 °C	Not applicable	
Relative humidity	0% to 80% (non-condensing)			
Digital interface	Micro-B USB 3.1 Gen 1 interface			
Camera controls	GenICam (GenICam Access)			
¹ See Mounting the heat sink on page 272. ² Output by <code>DeviceTemperature</code> ³ Ensure that the sensor is operated in the temperature range specified by the manufacturer. For any questions, please visit www.alliedvision.com/en/support . ⁴ Temperature values must be observed for the housing and for the cooling area.				

Table 28: Alvium 1800 U-120m/c specifications (sheet 2 of 2)

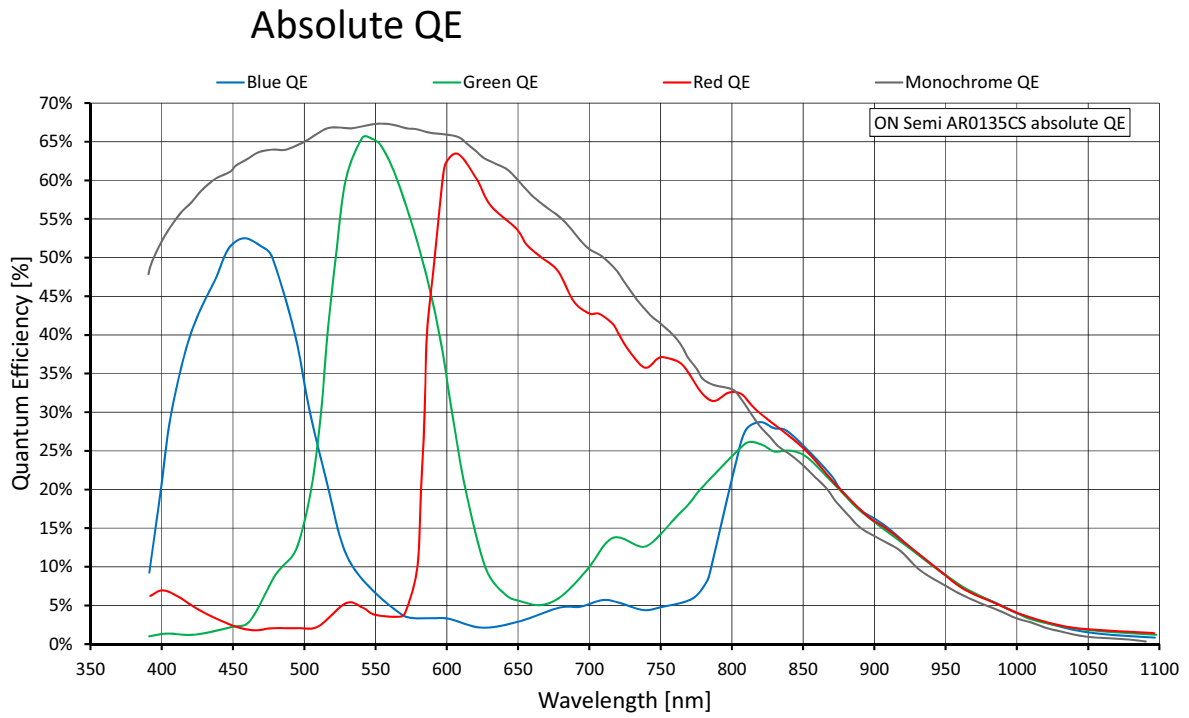

Figure 17: Alvium 1800 U-120m/c (ON Semi AR0135CS) absolute QE

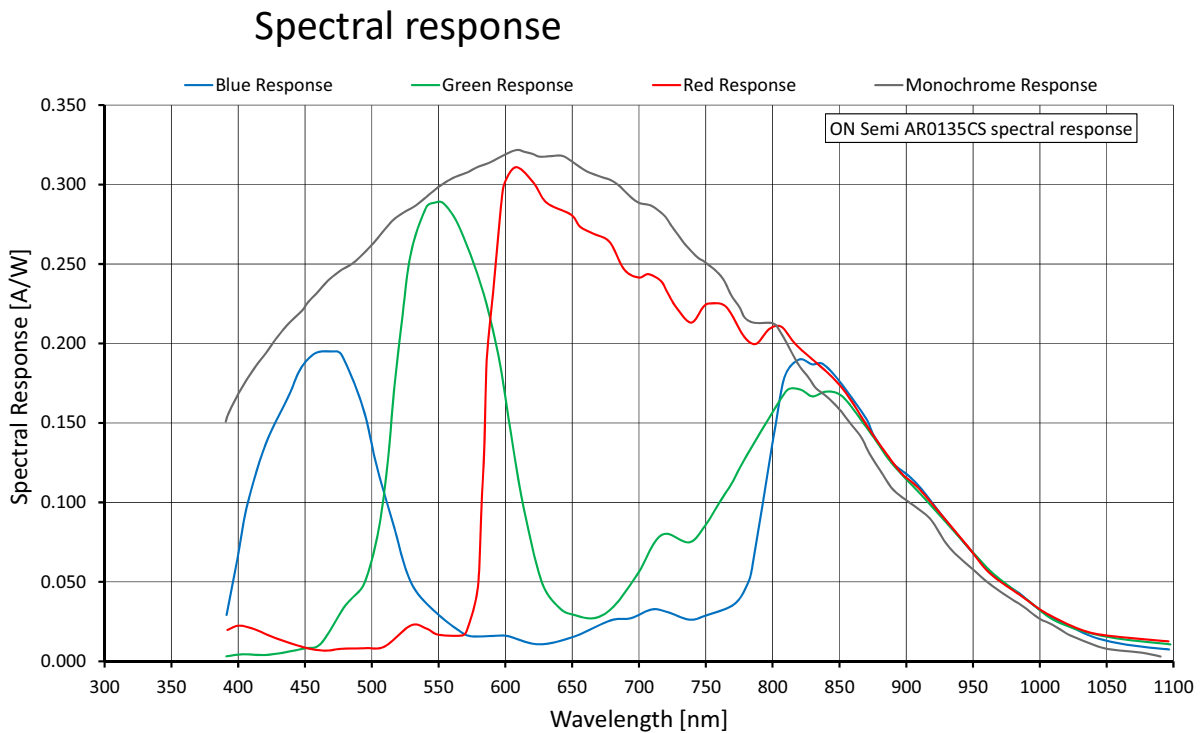

Figure 18: Alvium 1800 U-120m/c (ON Semi AR0135CS) spectral response

ROI frame rates

Values are based on the conditions defined in [Specified values](#) on page 77.

To reach the maximum frame rate available for this setup, the bandwidth for image traffic is 200 MByte/s. Increasing the `DeviceLinkThroughputLimit` value does not increase frame rates.

Alvium 1800 U-120 cameras do not allow overlapping of exposure and readout. **In triggered mode**, the maximum available frame rates may be reduced with long exposure times.

Image format	Width [pixels]	Height [pixels]	ROI area [MP]	Frame rate [fps] ¹		
				450 MByte/s	375 MByte/s	200 MByte/s
Full resolution	1280	960	1.229	52.8/52.8		
HD 720	1280	720	0.922	69.2/69.3	69.3/69.3	
XGA	1024	768	0.786	65.2/65.2		
SVGA	800	600	0.48	82.0/82.0		
VGA	640	480	0.307	100.5/100.5		
HVGA	480	320	0.154	143.8/143.8		
QVGA	320	240	0.077	161.2/161.2		
HQVGA	240	160	0.038	161.2/161.2		
QQVGA	160	120	0.019	161.2/161.2		
Max. × half	1280	480	0.614	100.5/100.5		
Max. × min.	1280	8	0.01	160.9/160.9		
Min. × max.	8	960	0.008	52.9/52.9		
Min. × min.	8	8	64 Px	161.2/161.2		

¹ Mono8 or Bayer...8⁽²⁾ at `SensorBitDepth` = 12-Bit /
Mono12 or Bayer...12 at `SensorBitDepth` = 12-Bit

² The three dots... represent the colors of a Bayer pixel format, such as in BayerRG8.

Table 29: Alvium 1800 U-120m/c ROI frame rates

Alvium 1800 U-130 VSWIR



Heat affecting your application

Image noise is increased by high operating temperatures, especially with Alvium VSWIR models. Therefore, we recommend you to optimize your SWIR application for heat dissipation. For more information on heat dissipation, see the Heat Dissipation for Housed Alvium CSI-2, USB, and G1 Cameras application note at www.alliedvision.com/en/support/technical-documentation/alvium-usb-documentation.

Feature	Specification
	1800 U-130 VSWIR
Sensor model	Sony IMX990
Resolution	1296 (H) × 1032 (V); 1.3 MP
Sensor type	InGaAs
Shutter type	Global shutter (GS)
Sensor size	Type 1/2; 6.4 mm × 5.1 mm; 8.2 mm diagonal
Pixel size	5 μm × 5 μm
CRA	0 deg
Sensor bit depth (ADC)	8-bit, 10-bit, 12-bit; Adaptive (10-bit, 12-bit)
Monochrome pixel formats	Mono8 (default), Mono10, Mono10p, Mono12, Mono12p
Maximum frame rate	130 fps (at ≥200 MByte/s)
Exposure time	15 μs to 10 s (200 MByte/s)
Exposure modes	Timed, TriggerControlled, TriggerWidth
Gain	0 dB to 42 dB; 0.1 dB increments
Digital binning	Horizontal: 1 to 8 columns; Vertical: 1 to 8 rows
Multiple ROI (H × V)	<i>Free Tile Horizontal: 1 × 1 to 1 × 4 Vertical: 1 × 1 to 1 × 4</i>
Image buffer (RAM)	256 KByte
Non-volatile memory (Flash)	1024 KByte
GPIOs	4 programmable GPIOs As direct inputs (push-pull): 0 to 5.5 VDC As direct outputs (push-pull): 0 to 3.3 VDC at 12 mA
Power requirements	Power over USB; External power
Power consumption (typical, at 5 VDC)	USB power: 2.1 W External power: 2.3 W

Table 30: Alvium 1800 U-130 VSWIR specifications (sheet 1 of 2)

Feature	Specification			
	1800 U-130 VSWIR			
Storage temperature	-20 °C to +85 °C ambient temperature			
Operating temperature	Hardware option	Housing	Cooling area¹	Mainboard²
	Bare board ³	Not applicable	-20 °C to +85 °C	-20 °C to +85 °C
	Open housing ⁴	-20 °C to +65 °C		
	Closed housing	-20 °C to +65 °C	Not applicable	
Relative humidity	0% to 80% (non-condensing)			
Digital interface	Micro-B USB 3.1 Gen 1 interface			
Camera controls	GenICam (GenICam Access)			

¹ See [Mounting the heat sink](#) on page 272.

² Output by `DeviceTemperature`

³ Ensure that the sensor is operated in the temperature range specified by the manufacturer. For any questions, please visit www.alliedvision.com/en/support.

⁴ Temperature values must be observed for the housing **and** for the cooling area.

Table 30: Alvium 1800 U-130 VSWIR specifications (sheet 2 of 2)

Absolute QE

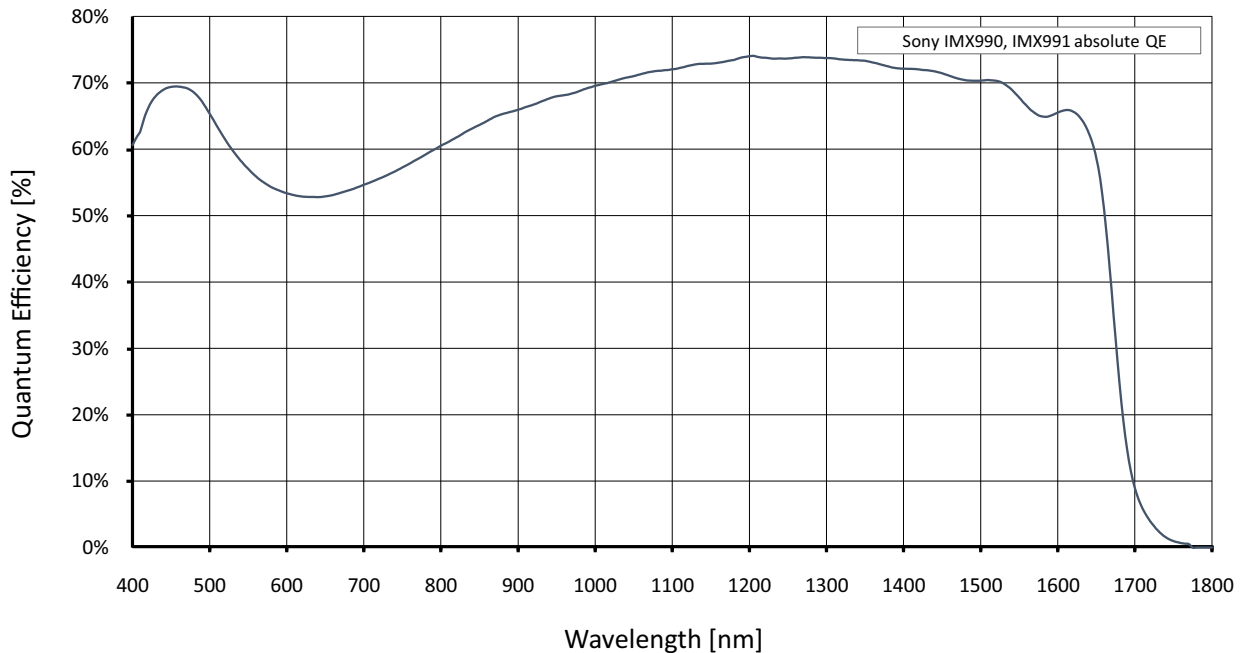

Figure 19: Alvium 1800 U-130 VSWIR (Sony IMX990) absolute QE

ROI frame rates

Values are based on the conditions defined in [Specified values](#) on page 77.

To reach the maximum frame rate available for this setup, the bandwidth for image traffic is 200 MByte/s. Increasing the `DeviceLinkThroughputLimit` value does not increase frame rates.

Image format	Width [pixels]	Height [pixels]	ROI area [MP]	Frame rate [fps] ¹		
				450 MByte/s	375 MByte/s	200 MByte/s
Full resolution	1296	1032	1.337	130.9/121.3/69.8		130.9/70.8/69.8
SXGA	1280	1024	1.311	131.8/122.2/70.3		131.8/72.4/70.3
HD 720	1280	720	0.922	183.3/169.8/97.8		183.3/100.8/97.8
XGA	1024	768	0.786	173.1/160.5/92.4		173.1/118.7/92.4
SVGA	800	600	0.48	218.3/202.1/116.4		218.3/190.5/116.4
VGA	640	480	0.307	267.9/248.3/143.0		267.9/248.3/143.0
HVGA	480	320	0.154	384.9/356.4/205.2		
QVGA	320	240	0.077	494.1/457.2/262.7		
HQVGA	240	160	0.038	683.2/634.4/365.0		
QQVGA	160	120	0.019	849.9/789.2/454.6		
Max. × half	1296	516	0.669	246.6/228.2/131.8		
Max. × min.	1296	8	0.01	2131.1/1921.6/1186.2		
Min. × max.	8	1032	0.008	132.5/123.0/70.4		
Min. × min.	8	8	64 Px	2644.2/2455.3/1405.9		

¹ Mono8 at `SensorBitDepth` = 8-Bit⁽²⁾ / Mono10 at `SensorBitDepth` = 10-Bit / Mono12 or at `SensorBitDepth` = 12-Bit

² The `SensorBitDepth` value must be set separately from `PixelFormat`. See [Sensor ADC readout modes for maximum frame rates](#) on page 77 for details.

Table 31: Alvium 1800 U-130 VSWIR ROI frame rates

Alvium 1800 U-131m/c



White balance with this Alvium model

Especially with long exposure times, bright image areas of e2v EV76C560 Sapphire sensors may appear slightly violet: At maximum saturation, the output for red and green is 255 as expected, while the output for blue drops down to approximately 240. Therefore, we recommend to slightly underexpose images to reduce this effect.

Feature	Specification	
	1800 U-131m (monochrome)	1800 U-131c (color)
Sensor model	e2v EV76C560 Sapphire	
Resolution	1280 (H) × 1024 (V); 1.3 MP	
Sensor type	CMOS	
Shutter type	Global shutter (GS)	
Sensor size	Type 1/1.8; 6.9 mm × 5.5 mm; 8.7 mm diagonal	
Pixel size	5.3 μm × 5.3 μm	
CRA	12 deg	
Sensor bit depth (ADC)	10-bit	
Monochrome pixel formats	Mono8 (default), Mono10, Mono10p, Mono12, Mono12p	Mono8, Mono10, Mono10p, Mono12, Mono12p
YUV color pixel formats	Not applicable	YCbCr411_8_CbYYCrYY, YCbCr422_8_CbYCrY, YCbCr8_CbYCr
RGB color pixel formats	Not applicable	BGR8, RGB8 (default)
Raw color pixel formats	Not applicable	BayerRG8, BayerRG10, BayerRG10p, BayerRG12, BayerRG12p
Maximum frame rate	60 fps (at ≥200 MByte/s)	
Exposure time	16 μs to 1 s (200 MByte/s)	
Exposure modes	Timed	
Gain	0 dB to 12.5 dB; 0.1 dB increments	
Digital binning	Horizontal: 1 to 8 columns; Vertical: 1 to 8 rows	
Image buffer (RAM)	256 KByte	
Non-volatile memory (Flash)	1024 KByte	
GPIOs	4 programmable GPIOs As direct inputs (push-pull): 0 to 5.5 VDC As direct outputs (push-pull): 0 to 3.3 VDC at 12 mA	

Table 32: Alvium 1800 U-131m/c specifications (sheet 1 of 2)

Feature	Specification			
	1800 U-131m/c			
Power requirements	Power over USB; External power			
Power consumption (typical, at 5 VDC)	USB power: 1.5 W External power: 1.5 W			
Storage temperature	-20 °C to +85 °C ambient temperature			
Operating temperature	Hardware option	Housing	Cooling area¹	Mainboard²
	Bare board ³	Not applicable	-20 °C to +85 °C	-20 °C to +85 °C
	Open housing ⁴	-20 °C to +65 °C		
	Closed housing	-20 °C to +65 °C	Not applicable	
Relative humidity	0% to 80% (non-condensing)			
Digital interface	Micro-B USB 3.1 Gen 1 interface			
Camera controls	GenICam (GenICam Access)			
¹ See Mounting the heat sink on page 272. ² Output by DeviceTemperature ³ Ensure that the sensor is operated in the temperature range specified by the manufacturer. For any questions, please visit www.alliedvision.com/en/support . ⁴ Temperature values must be observed for the housing and for the cooling area.				

Table 32: Alvium 1800 U-131m/c specifications (sheet 2 of 2)

Absolute QE, spectral response

We intend to add diagrams in a future version of this document.

ROI frame rates

Values are based on the conditions defined in [Specified values](#) on page 77.

To reach the maximum frame rate available for this setup, the bandwidth for image traffic is 200 MByte/s.

Image format	Width [pixels]	Height [pixels]	ROI area [MP]	Frame rate [fps] ¹		
				450 MByte/s	375 MByte/s	200 MByte/s
Full resolution, SXGA	1280	1024	1,311	60.7/60.7		
SXGA	1280	1024	1,311	60.7/60.7		
HD 720	1280	720	0,922	85.6/85.6		
XGA	1024	768	0,786	80.4/80.4		
SVGA	800	600	0,48	102.1/102.1		
VGA	640	480	0,307	126.4/126.4		
HVGA	480	320	0,154	185.4/185.4		
QVGA	320	240	0,077	241.8/241.8		
HQVGA	240	160	0,038	347.4/347.4		
QQVGA	160	120	0,019	444.5/444.5		
Max. × half	1280	512	0,655	118.9/118.9		
Max. × min.	1280	8	0,01	2046.2/2046.2		
Min. × max.	8	1024	0,008	60.7/60.7		
Min. × min.	8	8	64 Px	2046.3/2046.3		

¹ Mono8 or Bayer...8⁽²⁾ at **SensorBitDepth** = 10-Bit⁽³⁾ / Mono10 or Bayer...10 at **SensorBitDepth** = 10-Bit

² The three dots... represent the colors of a Bayer pixel format, such as in Bayer**RG8**.

³ The **SensorBitDepth** value must be set separately from **PixelFormat**.

See [Sensor ADC readout modes for maximum frame rates](#) on page 77 for details.

Table 33: Alvium 1800 U-131m/c ROI frame rates

Alvium 1800 U-158m/c

Feature	Specification	
	1800 U-158m (monochrome)	1800 U-158c (color)
Sensor model	Sony IMX273	
Resolution	1456 (H) × 1088 (V); 1.6 MP	
Sensor type	CMOS	
Shutter type	Global shutter (GS)	
Sensor size	Type 1/2.9; 5.0 mm × 3.8 mm; 6.3 mm diagonal	
Pixel size	3.45 μm × 3.45 μm	
CRA	0 deg	
Sensor bit depth (ADC)	8-bit, 10-bit, 12-bit; Adaptive (10-bit, 12-bit)	
Monochrome pixel formats	Mono8 (default), Mono10, Mono10p, Mono12, Mono12p	Mono8, Mono10, Mono10p, Mono12, Mono12p
YUV color pixel formats	Not applicable	YCbCr411_8_CbYYCrYY, YCbCr422_8_CbYCrY, YCbCr8_CbYCr
RGB color pixel formats	Not applicable	BGR8, RGB8 (default)
Raw color pixel formats	Not applicable	BayerRG8, BayerRG10, BayerRG10p, BayerRG12, BayerRG12p
Maximum frame rate	257 fps (at 450 MByte/s)	
Exposure time	28 μs to 10 s (450 MByte/s)	
Exposure modes	Timed, TriggerControlled, TriggerWidth	
Gain	0 dB to 48 dB; 0.1 dB increments	
Digital binning	Horizontal: 1 to 8 columns; Vertical: 1 to 8 rows	
Sensor binning (H × V)	1 × 2, 2 × 2 (<i>Sum</i>)	Not applicable
Multiple ROI (H × V)	<i>Free Tile</i>	
Image buffer (RAM)	256 KByte	
Non-volatile memory (Flash)	1024 KByte	
GPIOs	4 programmable GPIOs As direct inputs (push-pull): 0 to 5.5 VDC As direct outputs (push-pull): 0 to 3.3 VDC at 12 mA	
Power requirements	Power over USB; External power	
Power consumption (typical, at 5 VDC)	USB power: 2.5 W External power: 2.6 W	

Table 34: Alvium 1800 U-158m/c specifications (sheet 1 of 2)

Feature	Specification			
	1800 U-158m/c			
Storage temperature	-20 °C to +85 °C ambient temperature			
Operating temperature	Hardware option	Housing	Cooling area¹	Mainboard²
	Bare board ³	Not applicable	-20 °C to +85 °C	-20 °C to +85 °C
	Open housing ⁴	-20 °C to +65 °C		
	Closed housing	-20 °C to +65 °C	Not applicable	
Relative humidity	0% to 80% (non-condensing)			
Digital interface	Micro-B USB 3.1 Gen 1 interface			
Camera controls	GenICam (GenICam Access)			
¹ See Mounting the heat sink on page 272. ² Output by <code>DeviceTemperature</code> ³ Ensure that the sensor is operated in the temperature range specified by the manufacturer. For any questions, please visit www.alliedvision.com/en/support . ⁴ Temperature values must be observed for the housing and for the cooling area.				

Table 34: Alvium 1800 U-158m/c specifications (sheet 2 of 2)

Absolute QE

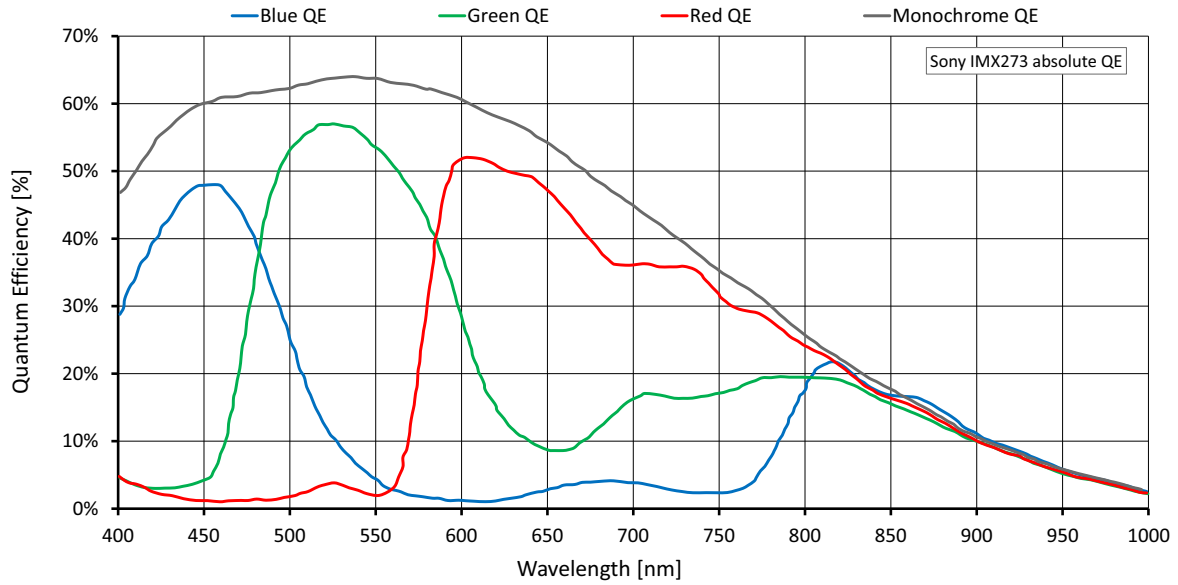

Figure 20: Alvium 1800 U-158m/c (Sony IMX273) absolute QE

Spectral response

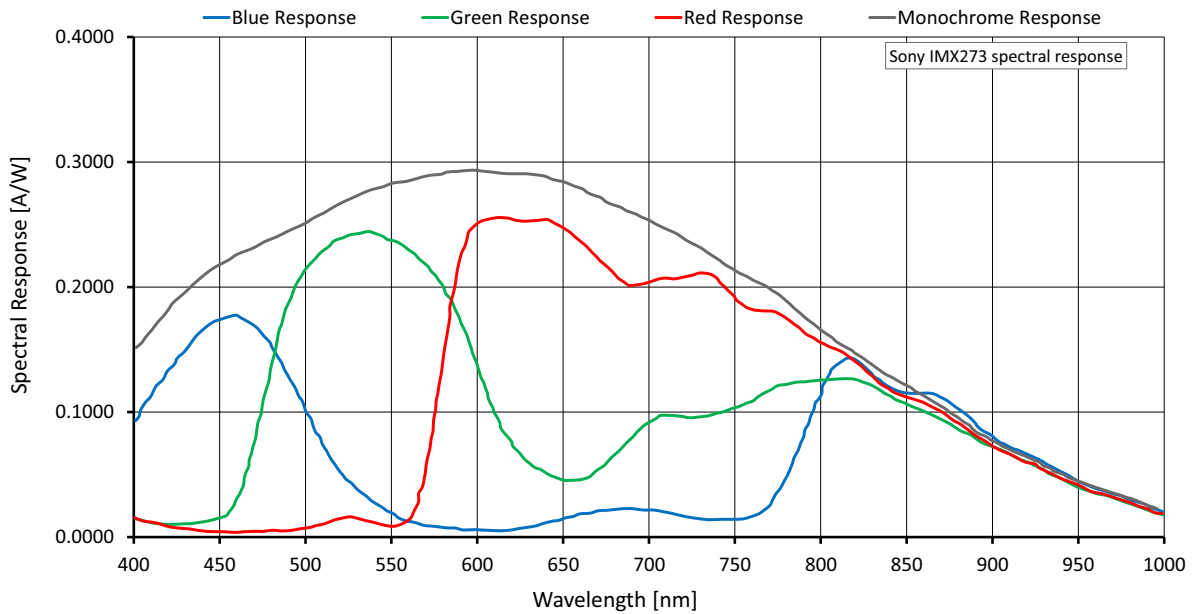

Figure 21: Alvium 1800 U-158m/c (Sony IMX273) spectral response

ROI frame rates

Values are based on the conditions defined in [Specified values](#) on page 77.

To reach the maximum frame rate available for this setup, the bandwidth for image traffic is 450 MByte/s.

Image format	Width [pixels]	Height [pixels]	ROI area [MP]	Frame rate [fps] ¹		
				450 MByte/s	375 MByte/s	200 MByte/s
Full resolution	1456	1088	1.584	257.9/130.3/130.8	216.8/110.5/109.7	118.1/59.8/59.3
WXGA+	1440	900	1.296	311.9/158.7/157.8	261.7/134.2/133.6	143.1/72.1/71.7
SXGA	1280	1024	1.311	278.2/157.1/155.7	261.3/133.0/132.5	142.8/72.0/71.5
HD 720	1280	720	0.922	382.9/217.2/214.8	359.8/184.1/183.1	198.0/99.9/99.3
XGA	1024	768	0.786	364.0/255.0/218.8	364.0/215.8/215.9	233.4/117.7/117.1
SVGA	800	600	0.48	457.6/372.9/275.3	457.6/344.8/275.3	368.8/188.5/188.2
VGA	640	480	0.307	560.5/456.8/337.7		560.5/288.4/284.3
HVGA	480	320	0.154	795.3/650.4/482.2		795.3/538.5/482.2
QVGA	320	240	0.077	1001.2/830.7/615.7		
HQVGA	240	160	0.038	1351.0/1138.9/847.2		
QQVGA	160	120	0.019	1636.9/1390.6/1037.6		
Max. × half	1456	544	0.792	478.5/244.8/244.8	404.3/208.2/206.1	223.0/113.4/112.4
Max. × min.	1456	8	0.012	3043.0/1825.6/ 1736.1	2734.2/1620.4/ 1537.1	1795.9/982.1/949.6
Min. × max.	8	1088	0.009	267.4/219.1/161.2		
Min. × min.	8	8	64 Px	4017.8/3647.7/2798.5		

¹ Mono8 or Bayer...8⁽²⁾ at SensorBitDepth = 8-Bit⁽³⁾ /
 Mono10 or Bayer...10 at SensorBitDepth = 10-Bit /
 Mono12 or Bayer...12 at SensorBitDepth = 12-Bit

² The three dots... represent the colors of a Bayer pixel format, such as in BayerRG8.

³ The SensorBitDepth value must be set separately from PixelFormat.

See [Sensor ADC readout modes for maximum frame rates](#) on page 77 for details.

Table 35: Alvium 1800 U-158m/c ROI frame rates

Alvium 1800 U-192m/c



White balance with this Alvium model

Especially with long exposure times, bright image areas of e2v EV76C570 Sapphire sensors may appear slightly violet: At maximum saturation, the output for red and green is 255 as expected, while the output for blue drops down to approximately 240. Therefore, we recommend to slightly underexpose images to reduce this effect.

Feature	Specification	
	1800 U-192m (monochrome)	1800 U-192c (color)
Sensor model	e2v EV76C570 Sapphire	
Resolution	1600 (H) × 1200 (V); 1.92 MP	
Sensor type	CMOS	
Shutter type	Global shutter (GS)	
Sensor size	Type 1/1.8; 7.2 mm × 5.4 mm; 9.0 mm diagonal	
Pixel size	4.5 μm × 4.5 μm	
CRA	12 deg	
Sensor bit depth (ADC)	10-bit	
Monochrome pixel formats	Mono8 (default), Mono10, Mono10p, Mono12, Mono12p	Mono8, Mono10, Mono10p, Mono12, Mono12p
YUV color pixel formats	Not applicable	YCbCr411_8_CbYYCrYY, YCbCr422_8_CbYCrY, YCbCr8_CbYCr
RGB color pixel formats	Not applicable	BGR8, RGB8 (default)
Raw color pixel formats	Not applicable	BayerRG8, BayerRG10, BayerRG10p, BayerRG12, BayerRG12p
Maximum frame rate	59 fps (at ≥200 MByte/s)	
Exposure time	14 μs to 0.8 s (200 MByte/s)	
Exposure modes	Timed	
Gain	0 dB to 12.5 dB; 0.1 dB increments	
Digital binning	Horizontal: 1 to 8 columns; Vertical: 1 to 8 rows	
Image buffer (RAM)	256 KByte	
Non-volatile memory (Flash)	1024 KByte	
GPIOs	4 programmable GPIOs As direct inputs (push-pull): 0 to 5.5 VDC As direct outputs (push-pull): 0 to 3.3 VDC at 12 mA	

Table 36: Alvium 1800 U-192m/c specifications (sheet 1 of 2)

Feature	Specification			
	1800 U-192m/c			
Power requirements	Power over USB; External power			
Power consumption (typical, at 5 VDC)	USB power: 1.6 W External power: 1.6 W			
Storage temperature	-20 °C to +85 °C ambient temperature			
Operating temperature	Hardware option	Housing	Cooling area¹	Mainboard²
	Bare board ³	Not applicable	-20 °C to +85 °C	-20 °C to +85 °C
	Open housing ⁴	-20 °C to +65 °C		
	Closed housing	-20 °C to +65 °C	Not applicable	
Relative humidity	0% to 80% (non-condensing)			
Digital interface	Micro-B USB 3.1 Gen 1 interface			
Camera controls	GenICam (GenICam Access)			
¹ See Mounting the heat sink on page 272. ² Output by DeviceTemperature ³ Ensure that the sensor is operated in the temperature range specified by the manufacturer. For any questions, please visit www.alliedvision.com/en/support . ⁴ Temperature values must be observed for the housing and for the cooling area.				

Table 36: Alvium 1800 U-192m/c specifications (sheet 2 of 2)

Absolute QE, spectral response

We intend to add diagrams in a future version of this document.

ROI frame rates

Values are based on the conditions defined in [Specified values](#) on page 77.

To reach the maximum frame rate available for this setup, the bandwidth for image traffic is 200 MByte/s.

Image format	Width [pixels]	Height [pixels]	ROI area [MP]	Frame rate [fps] ¹		
				450 MByte/s	375 MByte/s	200 MByte/s
Full resolution	1600	1200	1,92	59.5/59.5		59.5/51.1
UXGA	1600	1200	1,92	59.5/59.5		59.5/51.1
WXGA+	1440	900	1,296	79.6/79.6		79.6/75.2
SXGA	1280	1024	1,311	70.2/70.2		70.2/70.2
HD 720	1280	720	0,922	98.9/98.9		
XGA	1024	768	0,786	92.9/92.9		
SVGA	800	600	0,48	117.9/117.9		
VGA	640	480	0,307	145.9/145.9		
HVGA	480	320	0,154	213.9/213.9		
QVGA	320	240	0,077	278.7/278.7		
HQVGA	240	160	0,038	400.0/400.0		
QQVGA	160	120	0,019	511.2/511.2		
Max. × half	1600	600	0,96	116.7/116.7		
Max. × min.	1600	8	0,013	2288.7/2288.7		
Min. × max.	8	1200	0,01	60.1/60.1		
Min. × min.	8	8	64 Px	2310.8/2310.8		

¹ Mono8 or Bayer...8⁽²⁾ at **SensorBitDepth** = 8-Bit⁽³⁾ / Mono10 or Bayer...10 at **SensorBitDepth** = 10-Bit

² The three dots... represent the colors of a Bayer pixel format, such as in Bayer**RG8**.

³ The **SensorBitDepth** value must be set separately from **PixelFormat**.

See [Sensor ADC readout modes for maximum frame rates](#) on page 77 for details.

Table 37: Alvim 1800 U-192m/c ROI frame rates

Alvium 1800 U-203m/c

Feature	Specification	
	1800 U-203m (monochrome)	1800 U-203c (color)
Sensor model	IMX422	
Resolution	1632 (H) × 1248 (V); 2.03 MP	
Sensor type	CMOS	
Shutter type	Global shutter (GS)	
Sensor size	Type 1/1.7; 7.3 mm × 5.6 mm; 9.2 mm diagonal	
Pixel size	4.5 μm × 4.5 μm	
CRA	0° deg	
Sensor bit depth (ADC)	8-bit, 10-bit, 12-bit; Adaptive (10-bit, 12-bit)	
Monochrome pixel formats	Mono8 (default), Mono10, Mono10p, Mono12, Mono12p	Mono8, Mono10, Mono10p, Mono12, Mono12p
YUV color pixel formats	Not applicable	YCbCr411_8_CbYYCrYY, YCbCr422_8_CbYCrY, YCbCr8_CbYCr
RGB color pixel formats	Not applicable	BGR8, RGB8 (default)
Raw color pixel formats	Not applicable	BayerRG8, BayerRG10, BayerRG10p, BayerRG12, BayerRG12p
Maximum frame rate	200 fps (at 450 MByte/s)	
Exposure time	16 μs to 10 s (450 MByte/s)	
Exposure modes	Timed, TriggerControlled, TriggerWidth	
Gain	0 dB to 48 dB; 0.1 dB increments	
Digital binning	Horizontal: 1 to 8 columns; Vertical: 1 to 8 rows	
Sensor binning (H × V)	2 × 2 (<i>Sum, Average</i>)	Not applicable
Multiple ROI (H × V)	<i>Free Tile Horizontal</i> : 1 × 1 to 1 × 4 <i>Vertical</i> : 1 × 1 to 1 × 4	
Image buffer (RAM)	256 KByte	
Non-volatile memory (Flash)	1024 KByte	
GPIOs	4 programmable GPIOs As direct inputs (push-pull): 0 to 5.5 VDC As direct outputs (push-pull): 0 to 3.3 VDC at 12 mA	
Power requirements	Power over USB; External power	
Power consumption (typical, at 5 VDC)	USB power: 3.3 W External power: 3.3 W	

Table 38: Alvium 1800 U-203m/c specifications (sheet 1 of 2)

Feature	Specification			
	1800 U-203m/c			
Storage temperature	-20 °C to +85 °C ambient temperature			
Operating temperature	Hardware option	Housing	Cooling area¹	Mainboard²
	Bare board ³	Not applicable	-20 °C to +85 °C	-20 °C to +85 °C
	Open housing ⁴	-20 °C to +65 °C		
	Closed housing	-20 °C to +65 °C	Not applicable	
Relative humidity	0% to 80% (non-condensing)			
Digital interface	Micro-B USB 3.1 Gen 1 interface			
Camera controls	GenICam (GenICam Access)			
¹ See Mounting the heat sink on page 272. ² Output by <code>DeviceTemperature</code> ³ Ensure that the sensor is operated in the temperature range specified by the manufacturer. For any questions, please visit www.alliedvision.com/en/support . ⁴ Temperature values must be observed for the housing and for the cooling area.				

Table 38: Alvium 1800 U-203m/c specifications (sheet 2 of 2)

Absolute QE

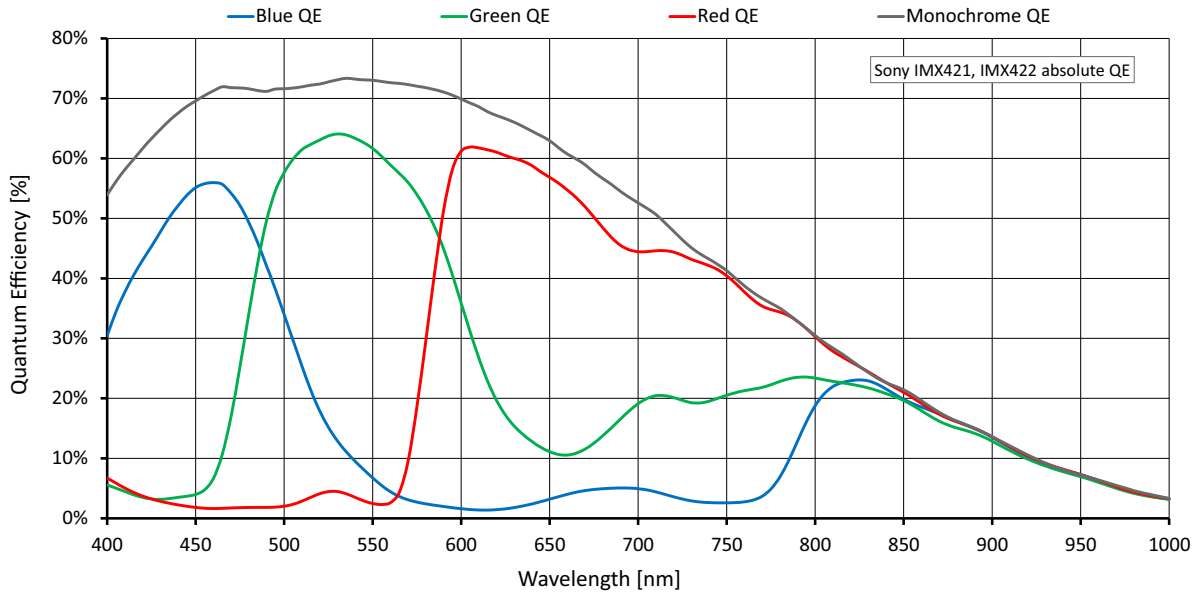

Figure 22: Alvium 1800 U-203m/c (Sony IMX422) absolute QE

Spectral response

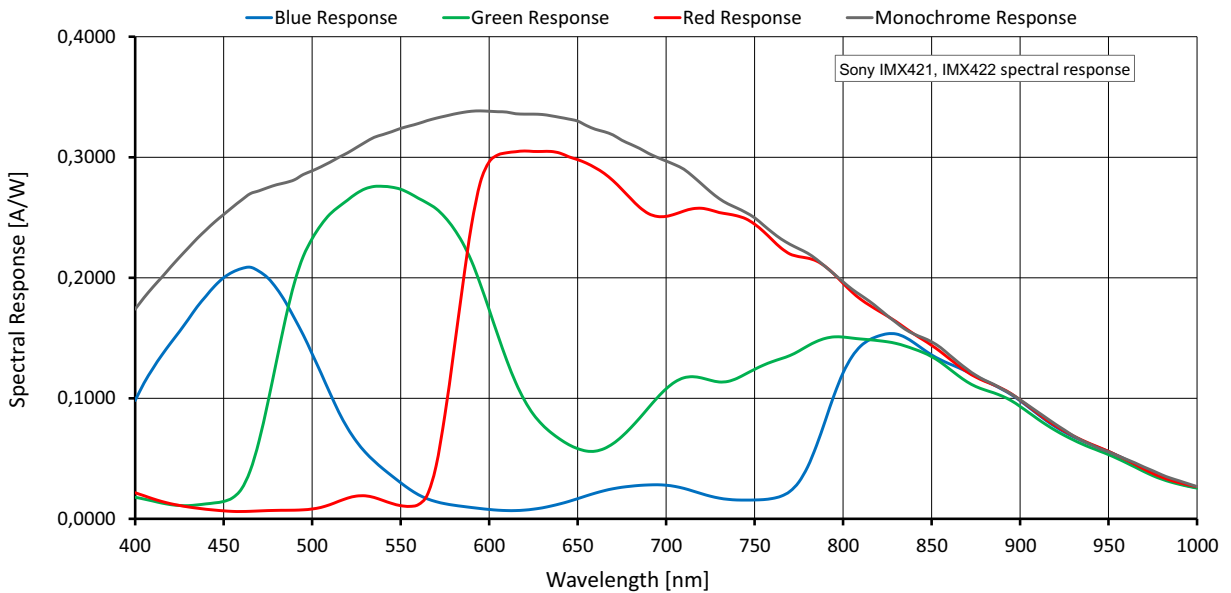

Figure 23: Alvium 1800 U-203m/c (Sony IMX422) spectral response

ROI frame rates

Values are based on the conditions defined in [Specified values](#) on page 77.

To reach the maximum frame rate available for this setup, the bandwidth for image traffic is 450 MByte/s.

Image format	Width [pixels]	Height [pixels]	ROI area [MP]	Frame rate [fps] ¹		
				450 MByte/s	375 MByte/s	200 MByte/s
Full resolution	1632	1248	2.037	200.0/101.0/100.7	168.8/84.9/85.2	91.0/45.7/45.9
WXGA+	1440	900	1.296	302.7/153.9/153.8	254.0/130.1/130.1	138.8/70.0/69.8
SXGA	1280	1024	1.311	271.9/153.5/152.6	255.3/129.9/129.9	139.5/70.3/70.1
HD 720	1280	720	0.922	370.9/210.3/209.1	348.6/178.2/178.2	191.6/96.7/96.6
XGA	1024	768	0.786	353.2/247.4/245.0	353.2/209.4/210.4	226.4/114.1/114.1
SVGA	800	600	0.48	440.7/359.0/306.1	440.7/331.9/306.1	355.1/181.4/182.2
VGA	640	480	0.307	535.2/436.2/373.0	535.2/436.2/373.0	535.2/275.2/273.3
HVGA	480	320	0.154	747.3/609.4/522.9		747.3/504.3/505.5
QVGA	320	240	0.077	937.5/765.0/658.5		
HQVGA	240	160	0.038	1247.5/1019.0/881.7		
QQVGA	160	120	0.019	1501.8/1227.8/1066.8		
Max. × half	1632	624	1.018	368.4/187.9/187.3	312.2/158.4/158.9	170.1/85.8/86.3
Max. × min.	1632	8	0.013	2183.8/1249.9/ 1236.2	1942.1/1087.9/ 1091.3	1197.3/636.6/651.7
Min. × max.	8	1248	0.01	232.6/189.4/161.1		
Min. × min.	8	8	64 Px	3437.4/2828.0/2540.0		

¹ Mono8 or Bayer...8⁽²⁾ at **SensorBitDepth** = 8-Bit⁽³⁾ /
 Mono10 or Bayer...10 at **SensorBitDepth** = 10-Bit /
 Mono12 or Bayer...12 at **SensorBitDepth** = 12-Bit

² The three dots... represent the colors of a Bayer pixel format, such as in BayerRG8.

³ The **SensorBitDepth** value must be set separately from **PixelFormat**.

See [Sensor ADC readout modes for maximum frame rates](#) on page 77 for details.

Table 39: Alvium 1800 U-203m/c ROI frame rates

Alvium 1800 U-234m/c

Feature	Specification	
	1800 U-234m	1800 U-234c
Sensor model	Sony IMX249	
Resolution	1936 (H) × 1216 (V); 2.35 MP	
Sensor type	CMOS	
Shutter type	Global shutter (GS)	
Sensor size	Type 1/1.2; 11.3 mm × 7.1 mm; 13.4 mm diagonal	
Pixel size	5.86 μm × 5.86 μm	
CRA	0 deg	
Sensor bit depth (ADC)	10-bit, 12-bit; Adaptive (10-bit, 12-bit)	
Monochrome pixel formats	Mono8 (default), Mono10, Mono10p, Mono12, Mono12p	Mono8, Mono10, Mono10p, Mono12, Mono12p
YUV color pixel formats	Not applicable	YCbCr411_8_CbYYCrYY, YCbCr422_8_CbYCrY, YCbCr8_CbYCr
RGB color pixel formats	Not applicable	BGR8, RGB8 (default)
Raw color pixel formats	Not applicable	BayerRG8, BayerRG10, BayerRG10p, BayerRG12, BayerRG12p
Maximum frame rate	40 fps (at ≥200 MByte/s)	
Exposure time	34 μs to 10 s (200 MByte/s)	
Exposure modes	Timed	
Gain	0 dB to 48 dB; 0.1 dB increments	
Digital binning	Horizontal: 1 to 8 columns; Vertical: 1 to 8 rows	
Multiple ROI (H × V)	<i>Free</i>	
Image buffer (RAM)	256 KByte	
Non-volatile memory (Flash)	1024 KByte	
GPIOs	4 programmable GPIOs As direct inputs (push-pull): 0 to 5.5 VDC As direct outputs (push-pull): 0 to 3.3 VDC at 12 mA	
Power requirements	Power over USB; External power	
Power consumption (typical, at 5 VDC)	USB power: 2.1 W External power: 2.3 W	

Table 40: Alvium 1800 U-234m/c specifications (sheet 1 of 2)

Feature	Specification			
	1800 U-234m/c			
Storage temperature	-20 °C to +85 °C ambient temperature			
Operating temperature	Hardware option	Housing	Cooling area¹	Mainboard²
	Bare board ³	Not applicable	-20 °C to +85 °C	-20 °C to +85 °C
	Open housing ⁴	-20 °C to +65 °C		
	Closed housing	-20 °C to +65 °C	Not applicable	
Relative humidity	0% to 80% (non-condensing)			
Digital interface	Micro-B USB 3.1 Gen 1 interface			
Camera controls	GenICam (GenICam Access)			
¹ See Mounting the heat sink on page 272. ² Output by <code>DeviceTemperature</code> ³ Ensure that the sensor is operated in the temperature range specified by the manufacturer. For any questions, please visit www.alliedvision.com/en/support . ⁴ Temperature values must be observed for the housing and for the cooling area.				

Table 40: Alvium 1800 U-234m/c specifications (sheet 2 of 2)

Absolute QE

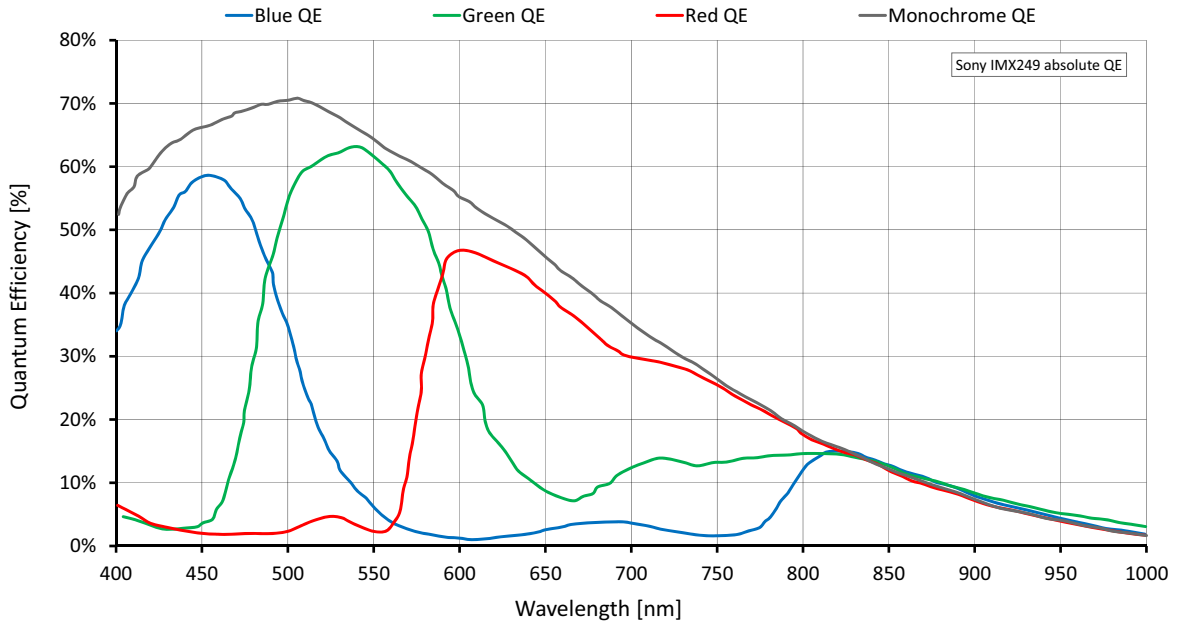

Figure 24: Alvim 1800 U-234m/c (Sony IMX249) absolute QE

Spectral response

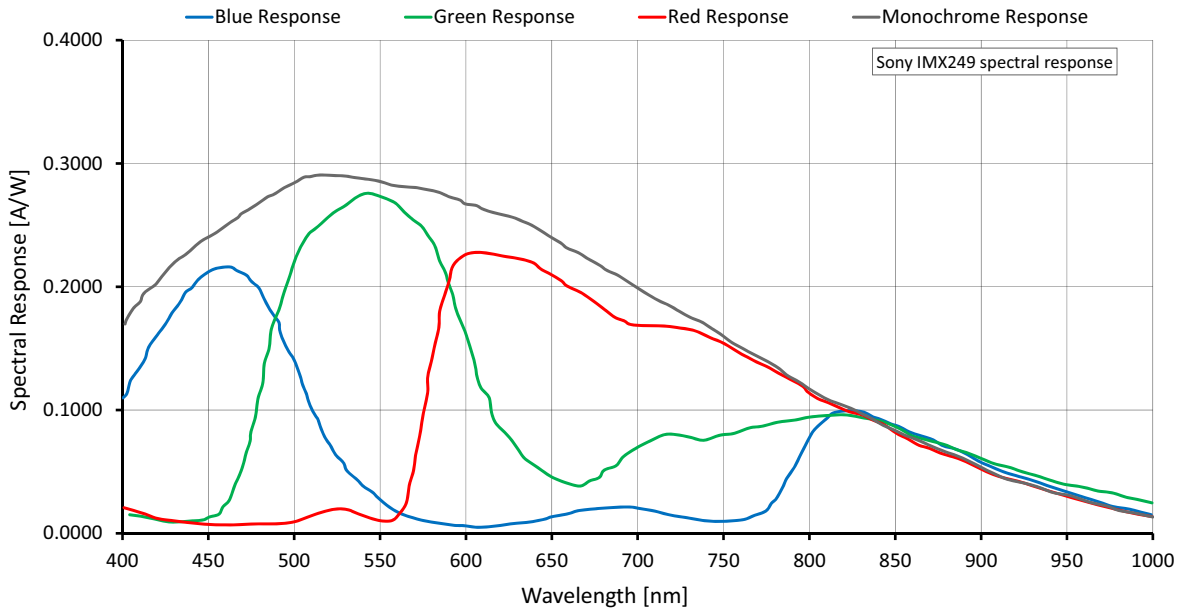

Figure 25: Alvim 1800 U-234m/c (Sony IMX249) spectral response

ROI frame rates

Values are based on the conditions defined in [Specified values](#) on page 77.

To reach the maximum frame rate available for this setup, the bandwidth for image traffic is 200 MByte/s. Increasing the `DeviceLinkThroughputLimit` value does not increase frame rates.

Image format	Width [pixels]	Height [pixels]	ROI area [MP]	Frame rate [fps] ¹		
				450 MByte/s	375 MByte/s	200 MByte/s
Full resolution	1936	1216	2.354	40.5/40.5/31.6		
Full HD	1920	1080	2.074	45.3/45.3/35.3		
UXGA	1600	1200	1.92	41.0/41.0/32.0		
WXGA+	1440	900	1.296	54.0/54.0/42.1		
SXGA	1280	1024	1.311	47.8/47.8/37.3		
HD 720	1280	720	0.922	66.6/66.6/51.9		
XGA	1024	768	0.786	62.7/62.7/48.9		
SVGA	800	600	0.48	79.1/79.1/61.6		
VGA	640	480	0.307	97.0/97.0/75.6		
HVGA	480	320	0.154	139.3/139.3/108.5		
QVGA	320	240	0.077	177.8/177.8/138.6		
HQVGA	240	160	0.038	245.9/245.9/192.5		
QQVGA	160	120	0.019	305.9/305.9/238.4		
Max. × half	1936	608	1.177	77.6/77.6/60.6		
Max. × min.	1936	8	0.015	828.8/828.8/656.5		
Min. × max.	8	1216	0.01	40.7/40.7/31.7		
Min. × min.	8	8	64 Px	917.6/917.6/715.1		

¹ Mono8 or Mono10, or Bayer...8⁽²⁾ or Bayer...10 at `SensorBitDepth` = 10-Bit⁽³⁾ / Mono12 or Bayer...12 at `SensorBitDepth` = 12-Bit

² The three dots... represent the colors of a Bayer pixel format, such as in BayerRG8.

³ The `SensorBitDepth` value must be set separately from `PixelFormat`.

See [Sensor ADC readout modes for maximum frame rates](#) on page 77 for details.

Table 41: Alvium 1800 U-234m/c ROI frame rates

Alvium 1800 U-235m/c

Feature	Specification	
	1800 U-235m	1800 U-235c
Sensor model	Sony IMX174	
Resolution	1936 (H) × 1216 (V); 2.35 MP	
Sensor type	CMOS	
Shutter type	Global shutter (GS)	
Sensor size	Type 1/1.2; 11.3 mm × 7.1 mm; 13.4 mm diagonal	
Pixel size	5.86 μm × 5.86 μm	
CRA	0 deg	
Sensor bit depth (ADC)	10-bit, 12-bit; Adaptive (10-bit, 12-bit)	
Monochrome pixel formats	Mono8 (default), Mono10, Mono10p, Mono12, Mono12p	Mono8, Mono10, Mono10p, Mono12, Mono12p
YUV color pixel formats	Not applicable	YCbCr411_8_CbYYCrYY, YCbCr422_8_CbYCrY, YCbCr8_CbYCr
RGB color pixel formats	Not applicable	BGR8, RGB8 (default)
Raw color pixel formats	Not applicable	BayerRG8, BayerRG10, BayerRG10p, BayerRG12, BayerRG12p
Maximum frame rate	155 fps (at 450 MByte/s)	
Exposure time	19 μs to 10 s (450 MByte/s)	
Exposure modes	Timed	
Gain	0 dB to 48 dB; 0.1 dB increments	
Digital binning	Horizontal: 1 to 8 columns; Vertical: 1 to 8 rows	
Multiple ROI (H × V)	<i>Free</i> <i>Tile</i> <i>Horizontal</i> : 1 × 1 to 1 × 4 <i>Vertical</i> : 1 × 1 to 1 × 4	
Image buffer (RAM)	256 KByte	
Non-volatile memory (Flash)	1024 KByte	
GPIOs	4 programmable GPIOs As direct inputs (push-pull): 0 to 5.5 VDC As direct outputs (push-pull): 0 to 3.3 VDC at 12 mA	
Power requirements	Power over USB; External power	
Power consumption (typical, at 5 VDC)	USB power: 2.8 W External power: 3.0 W	

Table 42: Alvium 1800 U-235m/c specifications (sheet 1 of 2)

Feature	Specification			
	1800 U-235m/c			
Storage temperature	-20 °C to +85 °C ambient temperature			
Operating temperature	Hardware option	Housing	Cooling area¹	Mainboard²
	Bare board ³	Not applicable	-20 °C to +85 °C	-20 °C to +85 °C
	Open housing ⁴	-20 °C to +65 °C		
	Closed housing	-20 °C to +65 °C	Not applicable	
Relative humidity	0% to 80% (non-condensing)			
Digital interface	Micro-B USB 3.1 Gen 1 interface			
Camera controls	GenICam (GenICam Access)			
¹ See Mounting the heat sink on page 272. ² Output by <code>DeviceTemperature</code> ³ Ensure that the sensor is operated in the temperature range specified by the manufacturer. For any questions, please visit www.alliedvision.com/en/support . ⁴ Temperature values must be observed for the housing and for the cooling area.				

Table 42: Alvium 1800 U-235m/c specifications (sheet 2 of 2)

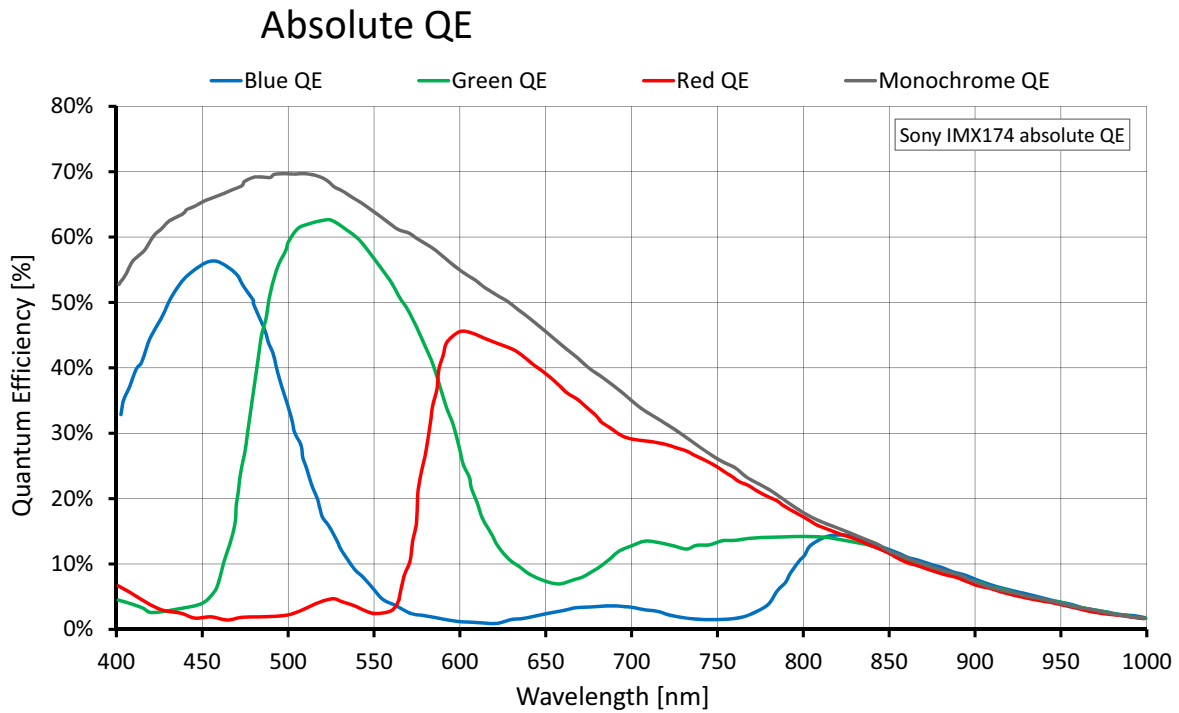

Figure 26: Alvium 1800 U-235m/c (Sony IMX174) absolute QE

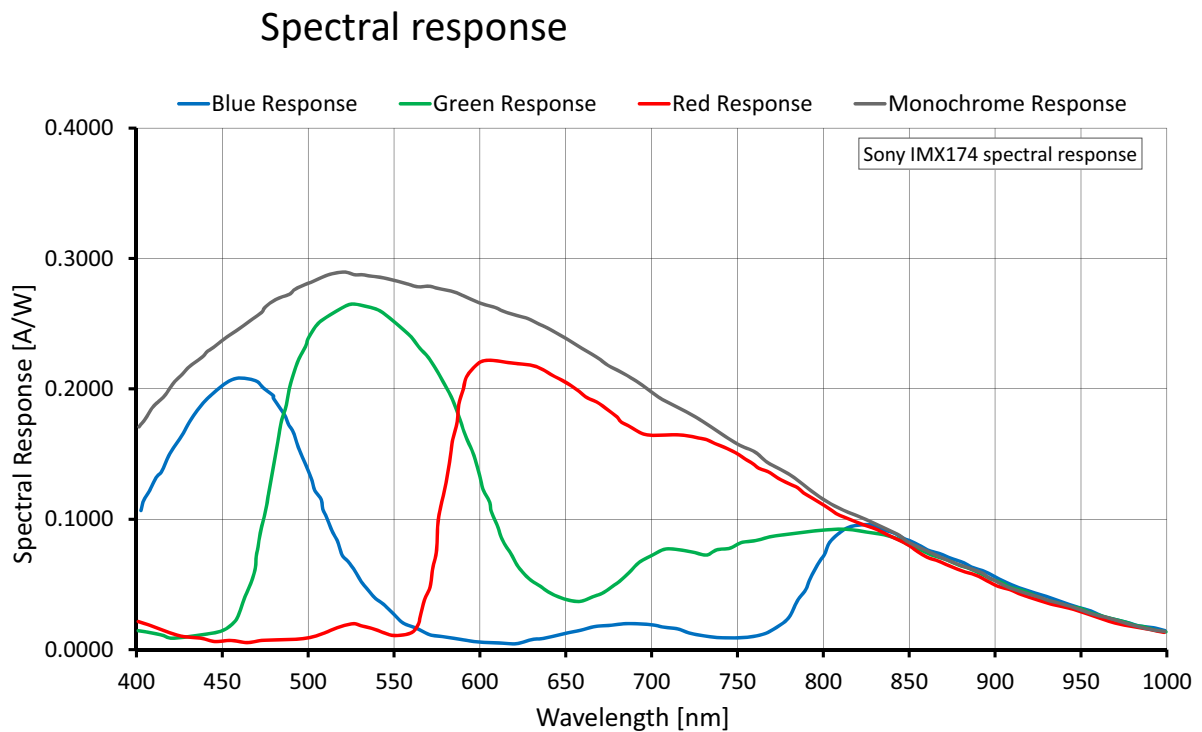

Figure 27: Alvium 1800 U-235m/c (Sony IMX174) spectral response

ROI frame rates

Values are based on the conditions defined in [Specified values](#) on page 77.

To reach the maximum frame rate available for this setup, the bandwidth for image traffic is 450 MByte/s.

Image format	Width [pixels]	Height [pixels]	ROI area [MP]	Frame rate [fps] ¹		
				450 MByte/s	375 MByte/s	200 MByte/s
Full resolution	1936	1216	2.354	155.9/88.8/88.8	148.0/75.2/75.1	80.3/40.5/40.4
Full HD	1920	1080	2.074	174.0/100.8/100.0	165.4/85.2/84.7	90.5/45.8/45.6
UXGA	1600	1200	1.92	158.7/109.2/109.0	158.7/92.3/91.9	98.3/49.6/49.6
WXGA+	1440	900	1.296	208.0/159.3/158.5	208.0/134.7/134.2	143.2/72.4/72.0
SXGA	1280	1024	1.311	185.1/157.7/144.6	185.1/133.4/133.0	143.0/72.2/71.8
HD 720	1280	720	0.922	255.9/218.3/200.1	255.9/185.0/184.1	198.1/100.5/99.8
XGA	1024	768	0.786	242.7/242.7/189.8	242.7/216.9/189.8	233.4/118.3/117.7
SVGA	800	600	0.48	305.9/305.9/238.9		305.9/189.6/189.4
VGA	640	480	0.307	375.3/375.3/293.3		375.3/290.5/286.5
HVGA	480	320	0.154	538.2/538.2/419.7		
QVGA	320	240	0.077	689.6/689.6/537.8		
HQVGA	240	160	0.038	955.0/955.0/744.8		
QQVGA	160	120	0.019	1182.7/1182.7/927.8		
Max. × half	1936	608	1.177	291.9/168.2/167.8	277.5/142.9/142.4	152.6/77.4/77.2
Max. × min.	1936	8	0.015	2097.1/1445.9/ 1380.5	2030.0/1285.7/ 1223.8	1356.9/781.2/ 758.3
Min. × max.	8	1216	0.01	160.7/160.7/125.3		
Min. × min.	8	8	64 Px	3507.3/3507.3/ 2735.4		

¹ Mono8 or Bayer...8⁽²⁾ at $\text{SensorBitDepth} = 10\text{-Bit}^{(3)}$ /
 Mono10 or Bayer...10⁽²⁾ at $\text{SensorBitDepth} = 10\text{-Bit}^{(3)}$ /
 Mono12 or Bayer...12 at $\text{SensorBitDepth} = 12\text{-Bit}$

² The three dots... represent the colors of a Bayer pixel format, such as in BayerRG8.

³ The **SensorBitDepth** value must be set separately from **PixelFormat**.

See [Sensor ADC readout modes for maximum frame rates](#) on page 77 for details.

Table 43: Alvium 1800 U-235m/c ROI frame rates

Alvium 1800 U-240m/c

Feature	Specification	
	1800 U-240m (monochrome)	1800 U-240c (color)
Sensor model	Sony IMX392	
Resolution	1936 (H) × 1216 (V); 2.4 MP	
Sensor type	CMOS	
Shutter type	Global shutter (GS)	
Sensor size	Type 1/2.3; 6.7 mm × 4.2 mm; 7.9 mm diagonal	
Pixel size	3.45 μm × 3.45 μm	
CRA	0 deg	
Sensor bit depth (ADC)	8-bit, 10-bit, 12-bit; Adaptive (10-bit, 12-bit)	
Monochrome pixel formats	Mono8 (default), Mono10, Mono10p, Mono12, Mono12p	Mono8, Mono10, Mono10p, Mono12, Mono12p
YUV color pixel formats	Not applicable	YCbCr411_8_CbYYCrYY, YCbCr422_8_CbYCrY, YCbCr8_CbYCr
RGB color pixel formats	Not applicable	BGR8, RGB8 (default)
Raw color pixel formats	Not applicable	BayerRG8, BayerRG10, BayerRG10p, BayerRG12, BayerRG12p
Maximum frame rate	176 fps (at 450 MByte/s)	
Exposure time	23 μs to 10 s (450 MByte/s)	
Exposure modes	Timed, TriggerControlled, TriggerWidth	
Gain	0 dB to 48 dB; 0.1 dB increments	
Digital binning	Horizontal: 1 to 8 columns; Vertical: 1 to 8 rows	
Sensor binning (H × V)	2 × 2 (<i>Sum</i>)	Not applicable
Multiple ROI (H × V)	<i>Free</i> <i>Tile</i>	
Image buffer (RAM)	256 KByte	
Non-volatile memory (Flash)	1024 KByte	
GPIOs	4 programmable GPIOs As direct inputs (push-pull): 0 to 5.5 VDC As direct outputs (push-pull): 0 to 3.3 VDC at 12 mA	
Power requirements	Power over USB; External power	
Power consumption (typical, at 5 VDC)	USB power: 2.8 W External power: 3.0 W	

Table 44: Alvium 1800 U-240m/c specifications (sheet 1 of 2)

Feature	Specification			
	1800 U-240m/c			
Storage temperature	-20 °C to +85 °C ambient temperature			
Operating temperature	Hardware option	Housing	Cooling area¹	Mainboard²
	Bare board ³	Not applicable	-20 °C to +85 °C	-20 °C to +85 °C
	Open housing ⁴	-20 °C to +65 °C		
	Closed housing	-20 °C to +65 °C	Not applicable	
Relative humidity	0% to 80% (non-condensing)			
Digital interface	Micro-B USB 3.1 Gen 1 interface			
Camera controls	GenICam (GenICam Access)			
¹ See Mounting the heat sink on page 272. ² Output by <code>DeviceTemperature</code> ³ Ensure that the sensor is operated in the temperature range specified by the manufacturer. For any questions, please visit www.alliedvision.com/en/support . ⁴ Temperature values must be observed for the housing and for the cooling area.				

Table 44: Alvium 1800 U-240m/c specifications (sheet 2 of 2)

Absolute QE

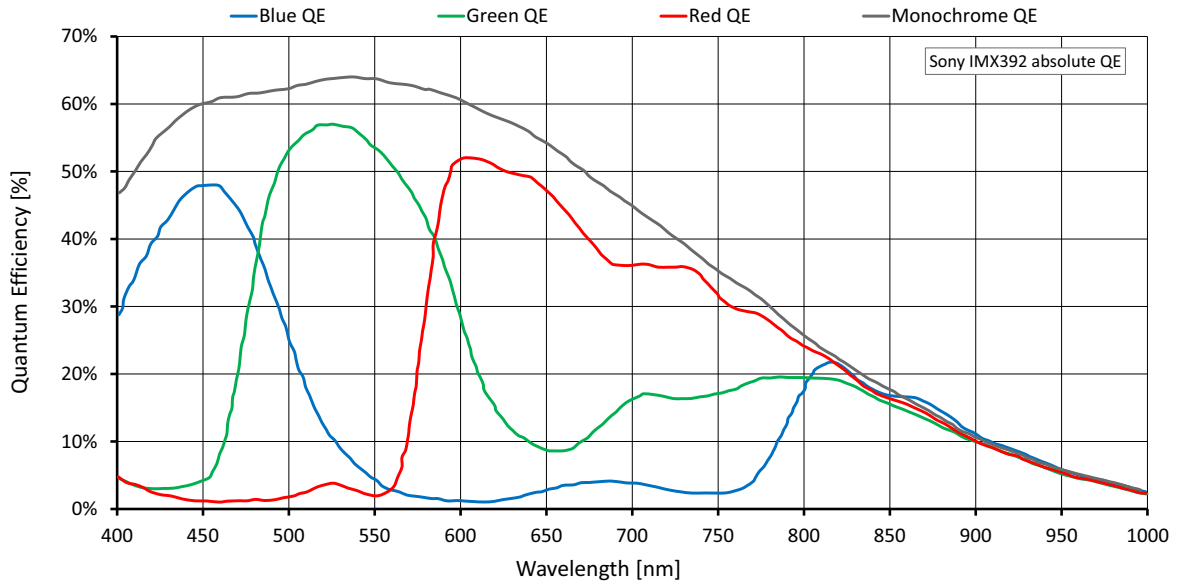

Figure 28: Alvium 1800 U-240m/c (Sony IMX392) absolute QE

Spectral response

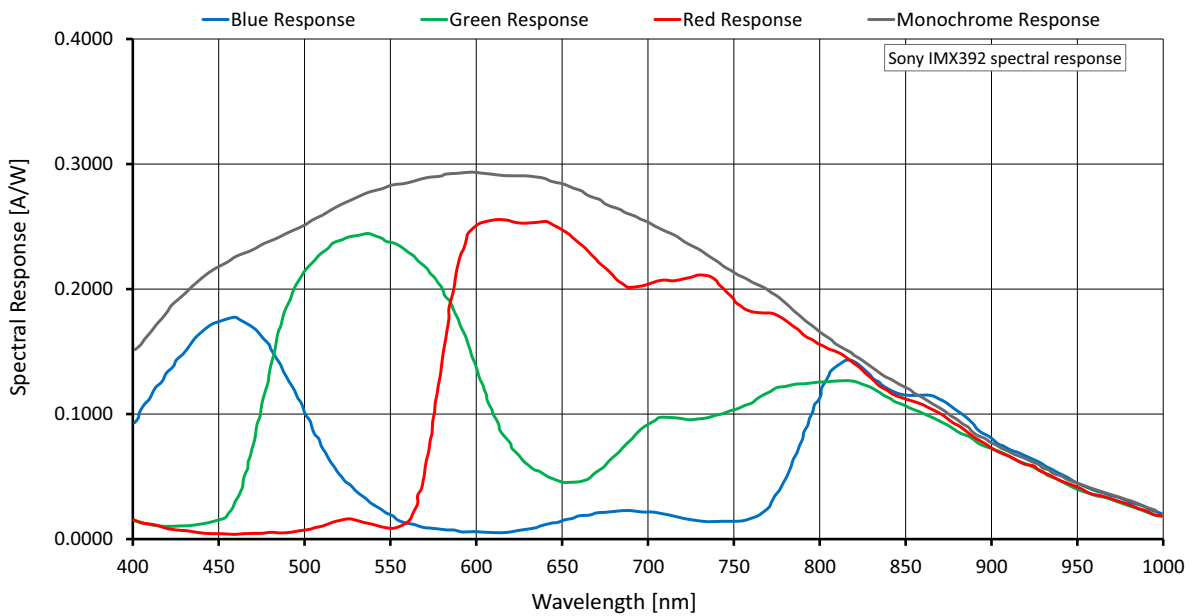

Figure 29: Alvium 1800 U-240m/c (Sony IMX392) spectral response

ROI frame rates

Values are based on the conditions defined in [Specified values](#) on page 77.

To reach the maximum frame rate available for this setup, the bandwidth for image traffic is 450 MByte/s.

Image format	Width [pixels]	Height [pixels]	ROI area [MP]	Frame rate [fps] ¹		
				450 MByte/s	375 MByte/s	200 MByte/s
Full resolution	1936	1216	2.354	176.0/88.9/89.0	149.3/75.3/75.4	80.6/40.5/40.5
Full HD	1920	1080	2.074	199.0/101.0/100.4	166.8/85.3/85.0	90.6/45.9/45.8
UXGA	1600	1200	1.92	195.5/109.4/109.3	181.3/92.4/92.1	98.6/49.7/49.8
WXGA+	1440	900	1.296	256.0/159.6/159.1	256.0/135.0/134.7	143.7/72.6/72.3
SXGA	1280	1024	1.311	227.8/158.0/152.7	227.8/133.7/133.4	143.4/72.4/72.1
HD 720	1280	720	0.922	314.7/218.9/211.4	314.7/185.5/185.0	199.0/100.7/100.3
XGA	1024	768	0.786	299.0/246.4/200.8	299.0/217.4/200.8	234.6/118.6/118.3
SVGA	800	600	0.48	376.1/310.6/253.0		371.1/190.2/190.5
VGA	640	480	0.307	461.1/381.2/310.8		461.1/291.6/288.6
HVGA	480	320	0.154	658.4/547.1/447.1		
QVGA	320	240	0.077	833.4/701.5/574.7		
HQVGA	240	160	0.038	1135.0/968.3/796.3		
QQVGA	160	120	0.019	1385.9/1192.2/983.7		
Max. × half	1936	608	1.177	330.2/168.7/168.8	281.5/143.3/143.2	153.5/77.7/77.7
Max. × min.	1936	8	0.015	2438.0/1483.5/ 1450.4	2222.5/1320.9/ 1289.1	1432.3/805.7/ 805.7
Min. × max.	8	1216	0.01	196.4/162.5/132.1		
Min. × min.	8	8	64 Px	3635.5/3381.1/2883.3		

¹ Mono8 or Bayer...8⁽²⁾ at **SensorBitDepth** = 8-Bit⁽³⁾ /
 Mono10 or Bayer...10 at **SensorBitDepth** = 10-Bit /
 Mono12 or Bayer...12 at **SensorBitDepth** = 12-Bit

² The three dots... represent the colors of a Bayer pixel format, such as in Bayer**RG8**.

³ The **SensorBitDepth** value must be set separately from **PixelFormat**.
 See [Sensor ADC readout modes for maximum frame rates](#) on page 77 for details.

Table 45: Alvium 1800 U-240m/c ROI frame rates

Alvium 1800 U-291m/c

Feature	Specification	
	1800 U-291m (monochrome)	1800 U-291c (color)
Sensor model	Sony IMX421	
Resolution	1944 (H) x 1472 (V); 2.9 MP	
Sensor type	CMOS	
Shutter type	Global shutter (GS)	
Sensor size	Type 2/3; 8.8 mm x 6.6 mm; 10.8 mm diagonal	
Pixel size	4.5 μm x 4.5 μm	
CRA	0 deg	
Sensor bit depth (ADC)	8-bit, 10-bit, 12-bit; Adaptive (10-bit, 12-bit)	
Monochrome pixel formats	Mono8 (default), Mono10, Mono10p, Mono12, Mono12p	Mono8, Mono10, Mono10p, Mono12, Mono12p
YUV color pixel formats	Not applicable	YCbCr411_8_CbYYCrYY, YCbCr422_8_CbYCrY, YCbCr8_CbYCr
RGB color pixel formats	Not applicable	BGR8, RGB8 (default)
Raw color pixel formats	Not applicable	BayerRG8, BayerRG10, BayerRG10p, BayerRG12, BayerRG12p
Maximum frame rate	144 fps (at 450 MByte/s)	
Exposure time	14 μs to 10 s (450 MByte/s)	
Exposure modes	Timed, TriggerControlled, TriggerWidth	
Gain	0 dB to 48 dB; 0.1 dB increments	
Digital binning	Horizontal: 1 to 8 columns; Vertical: 1 to 8 rows	
Sensor binning (H x V)	2 x 2 (<i>Sum, Average</i>)	Not applicable
Multiple ROI (H x V)	<i>Free Tile Horizontal</i> : 1 x 1 to 1 x 4 <i>Vertical</i> : 1 x 1 to 1 x 4	
Image buffer (RAM)	256 KByte	
Non-volatile memory (Flash)	1024 KByte	
GPIOs	4 programmable GPIOs As direct inputs (push-pull): 0 to 5.5 VDC As direct outputs (push-pull): 0 to 3.3 VDC at 12 mA	
Power requirements	Power over USB; External power	
Power consumption (typical, at 5 VDC)	USB power: 4.0 W External power: 4.2 W	

Table 46: Alvium 1800 U-291m/c specifications (sheet 1 of 2)

Feature	Specification			
	1800 U-291m/c			
Storage temperature	-20 °C to +85 °C ambient temperature			
Operating temperature	Hardware option	Housing	Cooling area¹	Mainboard²
	Bare board ³	Not applicable	-20 °C to +85 °C	-20 °C to +85 °C
	Open housing ⁴	-20 °C to +65 °C		
	Closed housing	-20 °C to +65 °C	Not applicable	
Relative humidity	0% to 80% (non-condensing)			
Digital interface	Micro-B USB 3.1 Gen 1 interface			
Camera controls	GenICam (GenICam Access)			
¹ See Mounting the heat sink on page 272. ² Output by <code>DeviceTemperature</code> ³ Ensure that the sensor is operated in the temperature range specified by the manufacturer. For any questions, please visit www.alliedvision.com/en/support . ⁴ Temperature values must be observed for the housing and for the cooling area.				

Table 46: Alvium 1800 U-291m/c specifications (sheet 2 of 2)

Absolute QE

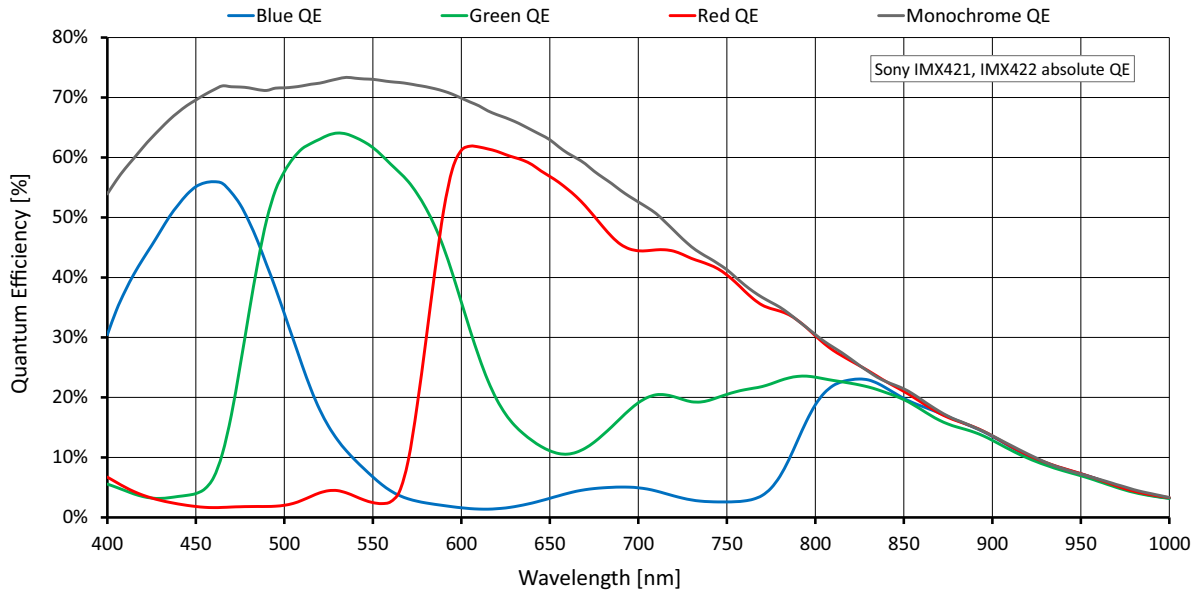

Figure 30: Alvium 1800 U-291m/c (Sony IMX421) absolute QE

Spectral response

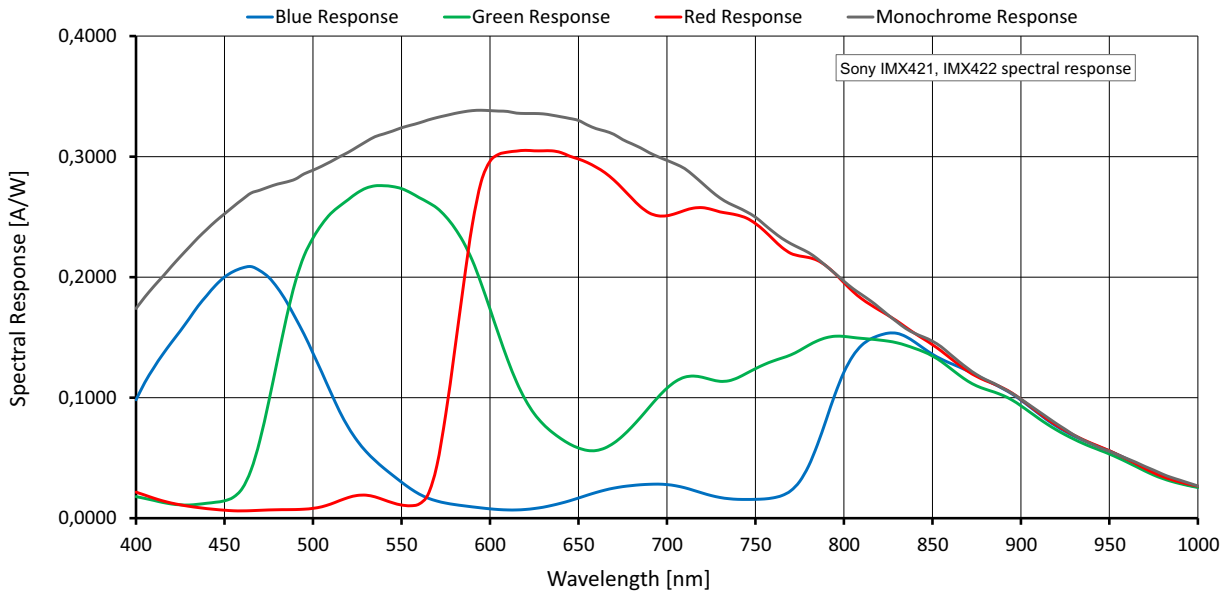

Figure 31: Alvium 1800 U-291m/c (Sony IMX421) spectral response

ROI frame rates

Values are based on the conditions defined in [Specified values](#) on page 77.

To reach the maximum frame rate available for this setup, the bandwidth for image traffic is 450 MByte/s.

Image format	Width [pixels]	Height [pixels]	ROI area [MP]	Frame rate [fps] ¹		
				450 MByte/s	375 MByte/s	200 MByte/s
Full resolution	1944	1472	2.862	144.3/72.8/73.0	121.0/61.6/61.3	65.5/33.0/33.0
Full HD	1920	1080	2.074	194.0/98.6/98.2	162.6/83.3/83.1	88.3/44.8/44.7
UXGA	1600	1200	1.92	201.7/107.0/107.1	177.1/90.4/90.3	96.3/48.6/48.8
WXGA+	1440	900	1.296	261.0/154.5/154.4	254.0/130.7/130.7	138.8/70.2/70.1
SXGA	1280	1024	1.311	234.3/154.0/153.2	234.3/130.3/130.3	139.5/70.5/70.4
HD 720	1280	720	0.922	320.3/211.3/210.1	320.3/179.1/179.1	191.6/97.2/97.0
XGA	1024	768	0.786	304.4/248.5/214.3	304.4/210.3/211.4	226.4/114.7/114.6
SVGA	800	600	0.48	379.9/315.1/268.1		355.1/182.4/183.3
VGA	640	480	0.307	462.0/383.1/326.9		462.0/277.2/275.2
HVGA	480	320	0.154	645.2/537.9/460.6		645.2/509.3/460.6
QVGA	320	240	0.077	810.9/676.1/580.8		
HQVGA	240	160	0.038	1077.9/906.1/782.6		
QQVGA	160	120	0.019	1299.9/1097.4/952.1		
Max. x half	1944	736	1.431	269.0/137.1/137.4	226.5/116.3/115.7	123.6/62.7/62.8
Max. x min.	1944	8	0.016	1848.1/1087.9/ 1081.0	1635.6/954.7/949.8	1005.4/558.5/570.5
Min. x max.	8	1472	0.012	170.7/141.1/119.7		
Min. x min.	8	8	64 Px	2979.5/2599.7/ 2338.0	2979.5/2599.8/2338.0	

¹ Mono8 or Bayer...8⁽²⁾ at **SensorBitDepth** = 8-Bit⁽³⁾ /
 Mono10 or Bayer...10 at **SensorBitDepth** = 10-Bit /
 Mono12 or Bayer...12 at **SensorBitDepth** = 12-Bit

² The three dots... represent the colors of a Bayer pixel format, such as in Bayer**RG8**.

³ The **SensorBitDepth** value must be set separately from **PixelFormat**.

See [Sensor ADC readout modes for maximum frame rates](#) on page 77 for details.

Table 47: Alvium 1800 U-291m/c ROI frame rates

Alvium 1800 U-319m/c

Feature	Specification	
	1800 U-319m (monochrome)	1800 U-319c (color)
Sensor model	Sony IMX265	
Resolution	2064 (H) × 1544 (V); 3.2 MP	
Sensor type	CMOS	
Shutter type	Global shutter (GS)	
Sensor size	Type 1/1.8; 7.1 mm × 5.3 mm; 8.9 mm diagonal	
Pixel size	3.45 μm × 3.45 μm	
CRA	0 deg	
Sensor bit depth (ADC)	12-bit	
Monochrome pixel formats	Mono8 (default), Mono10, Mono10p, Mono12, Mono12p	Mono8, Mono10, Mono10p, Mono12, Mono12p
YUV color pixel formats	Not applicable	YCbCr411_8_CbYYCrYY, YCbCr422_8_CbYCrY, YCbCr8_CbYCr
RGB color pixel formats	Not applicable	BGR8, RGB8 (default)
Raw color pixel formats	Not applicable	BayerRG8, BayerRG10, BayerRG10p, BayerRG12, BayerRG12p
Maximum frame rate	54 fps (at ≥200 MByte/s)	
Exposure time	26 μs to 10 s (200 MByte/s)	
Exposure modes	Timed, TriggerControlled, TriggerWidth	
Gain	0 dB to 48 dB; 0.1 dB increments	
Digital binning	Horizontal: 1 to 8 columns; Vertical: 1 to 8 rows	
Multiple ROI (H × V)	<i>Free</i>	
Image buffer (RAM)	256 KByte	
Non-volatile memory (Flash)	1024 KByte	
GPIOs	4 programmable GPIOs As direct inputs (push-pull): 0 to 5.5 VDC As direct outputs (push-pull): 0 to 3.3 VDC at 12 mA	
Power requirements	Power over USB; External power	
Power consumption (typical, at 5 VDC)	USB power: 2.2 W External power: 2.4 W	

Table 48: Alvium 1800 U-319m/c specifications (sheet 1 of 2)

Feature	Specification			
	1800 U-319m/c			
Storage temperature	-20 °C to +85 °C ambient temperature			
Operating temperature	Hardware option	Housing	Cooling area¹	Mainboard²
	Bare board ³	Not applicable	-20 °C to +85 °C	-20 °C to +85 °C
	Open housing ⁴	-20 °C to +65 °C		
	Closed housing	-20 °C to +65 °C	Not applicable	
Relative humidity	0% to 80% (non-condensing)			
Digital interface	Micro-B USB 3.1 Gen 1 interface			
Camera controls	GenICam (GenICam Access)			
¹ See Mounting the heat sink on page 272. ² Output by <code>DeviceTemperature</code> ³ Ensure that the sensor is operated in the temperature range specified by the manufacturer. For any questions, please visit www.alliedvision.com/en/support . ⁴ Temperature values must be observed for the housing and for the cooling area.				

Table 48: Alvium 1800 U-319m/c specifications (sheet 2 of 2)

Absolute QE

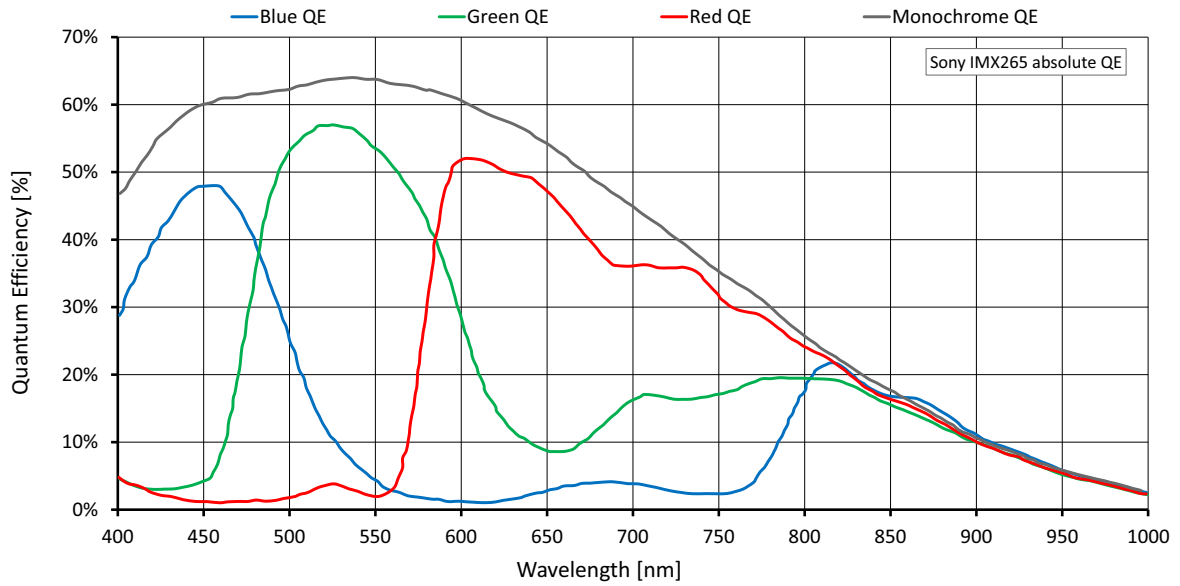

Figure 32: Alvium 1800 U-319m/c (Sony IMX265) absolute QE

Spectral response

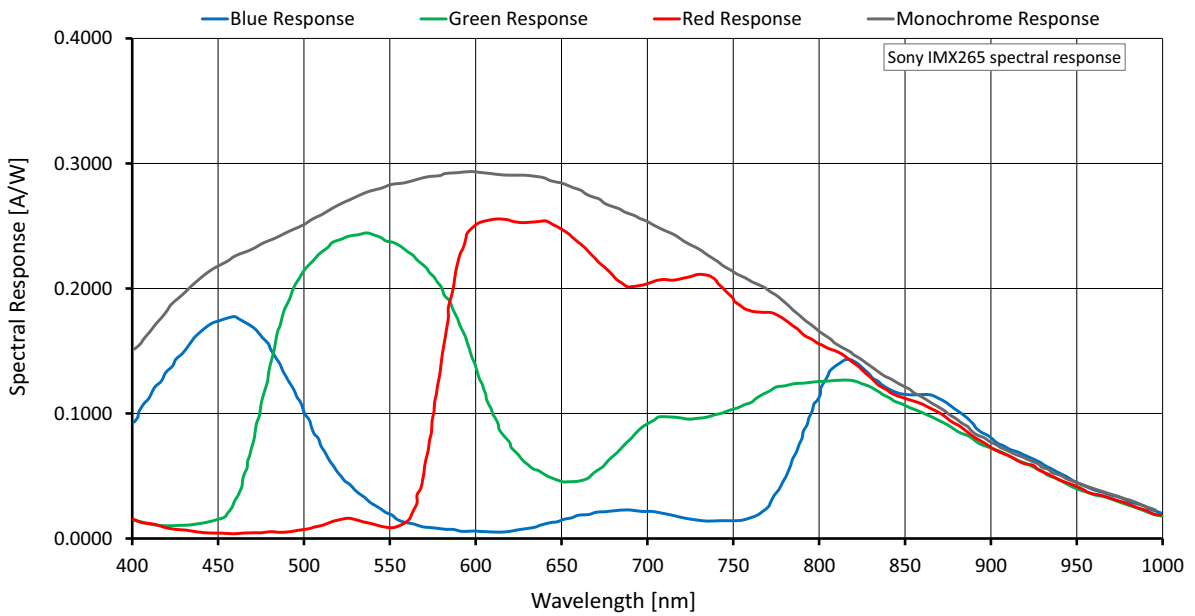

Figure 33: Alvium 1800 U-319m/c (Sony IMX265) spectral response

ROI frame rates

Values are based on the conditions defined in [Specified values](#) on page 77.

To reach the maximum frame rate available for this setup, the bandwidth for image traffic is 200 MByte/s. Increasing the `DeviceLinkThroughputLimit` value does not increase frame rates.

Image format	Width [pixels]	Height [pixels]	ROI area [MP]	Frame rate [fps] ¹		
				450 MByte/s	375 MByte/s	200 MByte/s
Full resolution	2064	1544	3.187	54.2/54.2		
QXGA	2048	1536	3.146	54.4/54.4		
Full HD	1920	1080	2.074	76.2/76.2		
UXGA	1600	1200	1.92	69.1/69.1		
WXGA+	1440	900	1.296	90.9/90.9		
SXGA	1280	1024	1.311	80.5/80.5		
HD 720	1280	720	0.922	112.0/112.0		
XGA	1024	768	0.786	105.9/105.9		
SVGA	800	600	0.48	133.5/133.5		
VGA	640	480	0.307	163.8/163.8		
HVGA	480	320	0.154	235.5/235.5		
QVGA	320	240	0.077	301.5/301.5		
HQVGA	240	160	0.038	419.0/419.0		
QQVGA	160	120	0.019	518.7/518.7		
Max. × half	2064	772	1.593	104.1/104.1		
Max. × min.	2064	8	0.017	1193.8/1193.8		
Min. × max.	8	1544	0.012	54.7/54.7		
Min. × min.	8	8	64 Px	1556.2/1556.2		

¹ Mono8 or Bayer...8⁽²⁾ at `SensorBitDepth` = 12-Bit / Mono12 or Bayer...12 at `SensorBitDepth` = 12-Bit

² The three dots... represent the colors of a Bayer pixel format, such as in BayerRG8.

Table 49: Alvim 1800 U-319m/c ROI frame rates

Alvium 1800 U-320 VSWIR



Heat affecting your application

Image noise is increased by high operating temperatures, especially with Alvium VSWIR models. Therefore, we recommend you to optimize your SWIR application for heat dissipation. For more information on heat dissipation, see the Heat Dissipation for Housed Alvium CSI-2, USB, and G1 Cameras application note at www.alliedvision.com/en/support/technical-documentation/alvium-usb-documentation.

Feature	Specification
	1800 U-320 VSWIR
Sensor model	Sony IMX993
Resolution	2080(H) × 1544 (V); 3.2 MP
Sensor type	InGaAs
Shutter type	Global shutter (GS)
Sensor size	Type 1/1.8; 7.2 mm × 5.3 mm; 8.9 mm diagonal
Pixel size	3.45 μm × 3.45 μm
CRA	0 deg
Sensor bit depth (ADC)	8-bit, 10-bit, 12-bit; Adaptive (10-bit, 12-bit)
Monochrome pixel formats	Mono8 (default), Mono10, Mono10p, Mono12, Mono12p
Maximum frame rate	123 fps (at 450 MByte/s)
Exposure time	34 μs to 10 s (450 MByte/s)
Exposure modes	Timed, TriggerControlled, TriggerWidth
Gain	0 dB to 42 dB; 0.1 dB increments
Digital binning	Horizontal: 1 to 8 columns; Vertical: 1 to 8 rows
Multiple ROI (H × V)	<i>Free Tile Horizontal: 1 × 1 to 1 × 4 Vertical: 1 × 1 to 1 × 4</i>
Image buffer (RAM)	256 KByte
Non-volatile memory (Flash)	1024 KByte
GPIOs	4 programmable GPIOs As direct inputs (push-pull): 0 to 5.5 VDC As direct outputs (push-pull): 0 to 3.3 VDC at 12 mA
Power requirements	Power over USB; External power
Power consumption (typical, at 5 VDC)	USB power: 2.8 W External power: 2.8 W

Table 50: Alvium 1800 U-320 VSWIR specifications (sheet 1 of 2)

Feature	Specification			
	1800 U-320 VSWIR			
Storage temperature	-20 °C to +85 °C ambient temperature			
Operating temperature	Hardware option	Housing	Cooling area¹	Mainboard²
	Bare board ³	Not applicable	-20 °C to +85 °C	-20 °C to +85 °C
	Open housing ⁴	-20 °C to +65 °C		
	Closed housing	-20 °C to +65 °C	Not applicable	
Relative humidity	0% to 80% (non-condensing)			
Digital interface	Micro-B USB 3.1 Gen 1 interface			
Camera controls	GenICam (GenICam Access)			

¹ See [Mounting the heat sink](#) on page 272.

² Output by `DeviceTemperature`

³ Ensure that the sensor is operated in the temperature range specified by the manufacturer. For any questions, please visit www.alliedvision.com/en/support.

⁴ Temperature values must be observed for the housing **and** for the cooling area.

Table 50: Alvium 1800 U-320 VSWIR specifications (sheet 2 of 2)

Absolute QE

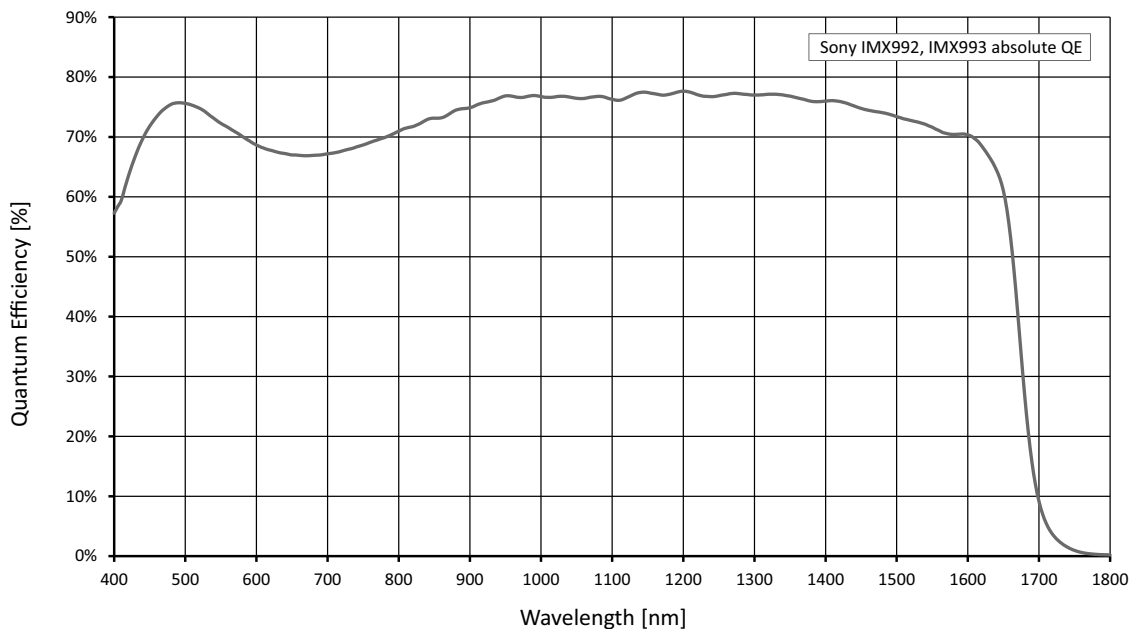

Figure 34: Alvium 1800 U-320 VSWIR (Sony IMX993) absolute QE
According to manufacturer data

ROI frame rates

Values are based on the conditions defined in [Specified values](#) on page 77.

To reach the maximum frame rate available for this setup, the bandwidth for image traffic is 450 MByte/s.

Image format	Width [pixels]	Height [pixels]	ROI area [MP]	Frame rate [fps] ¹		
				450 MByte/s	375 MByte/s	200 MByte/s
Full resolution	2080	1544	3,212	123.9/62.6/62.3	105.1/52.8/52.5	56.6/28.4/28.3
QXGA	2048	1536	3,146	125.9/63.8/63.7	106.6/53.7/53.6	57.7/29.0/28.9
Full HD	1920	1080	2,074	180.1/93.3/92.7	154.6/78.9/78.4	83.9/42.4/42.2
UXGA	1600	1200	1,92	165.1/101.8/101.6	165.1/86.0/85.7	91.9/46.2/46.2
WXGA+	1440	900	1,296	211.2/145.0/140.9	211.2/122.5/122.1	130.7/65.8/65.5
SXGA	1280	1024	1,311	190.4/145.5/127.0	190.4/123.1/122.7	132.2/66.6/66.2
HD 720	1280	720	0,922	255.8/195.6/170.7	255.8/165.6/164.9	178.1/89.8/89.3
XGA	1024	768	0,786	243.9/200.0/162.8	243.9/195.4/162.8	211.2/106.4/105.9
SVGA	800	600	0,48	299.4/245.5/199.9		299.4/166.4/166.2
VGA	640	480	0,307	357.6/293.7/238.8		357.6/248.1/238.8
HVGA	480	320	0,154	481.6/395.8/321.8		
QVGA	320	240	0,077	584.9/480.9/391.0		
HQVGA	240	160	0,038	739.8/608.6/494.8		
QQVGA	160	120	0,019	857.5/705.8/573.8		
Max. × half	2080	772	1,606	223.6/113.8/113.1	190.3/96.3/95.5	103.2/51.9/51.7
Max. × min.	2080	8	0,017	1147.1/624.8/609.6	1006.8/538.9/524.4	586.5/304.2/299.8
Min. × max.	8	1544	0,012	134.3/110.2/89.6		
Min. × min.	8	8	0	1509.1/1245.8/1019.7		

¹ Mono8 at **SensorBitDepth** = 8-Bit⁽²⁾ / Mono10 at **SensorBitDepth** = 10-Bit / Mono12 or at **SensorBitDepth** = 12-Bit

² The **SensorBitDepth** value must be set separately from **PixelFormat**.
See [Sensor ADC readout modes for maximum frame rates](#) on page 77 for details.

Table 51: Alvium 1800 U-320 VSWIR ROI frame rates

Alvium 1800 U-500m/c

Feature	Specification	
	1800 U-500m (monochrome)	1800 U-500c (color)
Sensor model	ON Semiconductor AR0521SR	
Resolution	2592 (H) × 1944 (V); 5.0 MP	
Sensor type	CMOS	
Shutter type	Rolling shutter (RS)	
Sensor size	Type 1/2.5; 5.7 mm × 4.3 mm; 7.1 mm diagonal	
Pixel size	2.2 μm × 2.2 μm	
CRA	9 deg	
Sensor bit depth (ADC)	10-bit	
Monochrome pixel formats	Mono8 (default), Mono10, Mono10p, Mono12, Mono12p	Mono8, Mono10, Mono10p, Mono12, Mono12p
YUV color pixel formats	Not applicable	YCbCr411_8_CbYYCrYY, YCbCr422_8_CbYCrY, YCbCr8_CbYCr
RGB color pixel formats	Not applicable	BGR8, RGB8 (default)
Raw color pixel formats	Not applicable	BayerGR8, BayerGR10, BayerGR10p, BayerGR12, BayerGR12p
Maximum frame rate	68 fps ¹ (at ≥375 MByte/s)	
Exposure time	8 μs to 0.48 s (375 MByte/s)	
Exposure modes	Timed	
Gain	0 dB to 24.1 dB; 0.1 dB increments	
Digital binning	Horizontal: 1 to 8 columns; Vertical: 1 to 8 rows	
Sensor binning (H × V)	2 × 2 (<i>Sum</i>)	
Image buffer (RAM)	256 KByte	
Non-volatile memory (Flash)	1024 KByte	
GPIOs	4 programmable GPIOs As direct inputs (push-pull): 0 to 5.5 VDC As direct outputs (push-pull): 0 to 3.3 VDC at 12 mA	
Power requirements	Power over USB; External power	
Power consumption (typical at 5 VDC)	USB power: 2.2 W External power: 2.4 W	

¹ In triggered mode: ~34 fps

Table 52: Alvium 1800 U-500m/c specifications (sheet 1 of 2)

Feature	Specification			
	1800 U-500m/c			
Storage temperature	-20 °C to +85 °C ambient temperature			
Operating temperature	Hardware option	Housing	Cooling area²	Mainboard³
	Bare board ⁴	Not applicable	-20 °C to +85 °C	-20 °C to +85 °C
	Open housing ⁵	-20 °C to +65 °C		
	Closed housing	-20 °C to +65 °C	Not applicable	
Relative humidity	0% to 80% (non-condensing)			
Digital interface	Micro-B USB 3.1 Gen 1 interface			
Camera controls	GenICam (GenICam Access)			
² See Mounting the heat sink on page 272. ³ Output by <code>DeviceTemperature</code> ⁴ Ensure that the sensor is operated in the temperature range specified by the manufacturer. For any questions, please visit www.alliedvision.com/en/support . ⁵ Temperature values must be observed for the housing and for the cooling area.				

Table 52: Alvium 1800 U-500m/c specifications (sheet 2 of 2)

Absolute QE

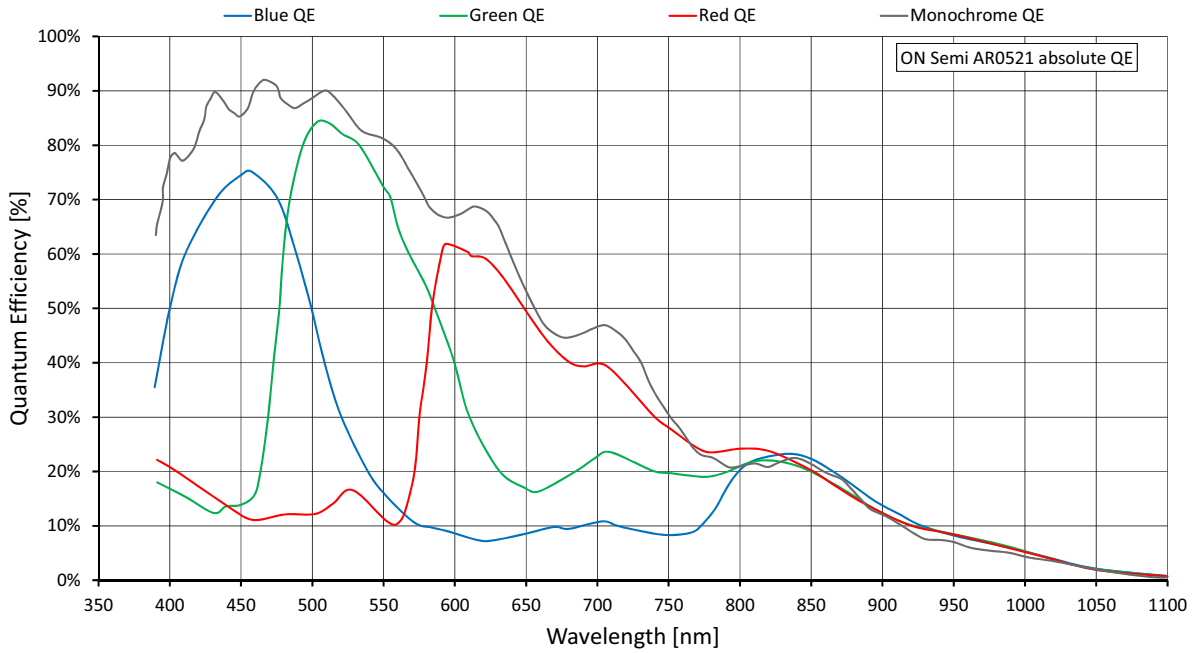

Figure 35: Alvim 1800 U-500m/c (ON Semi AR0521SR) absolute QE

Spectral response

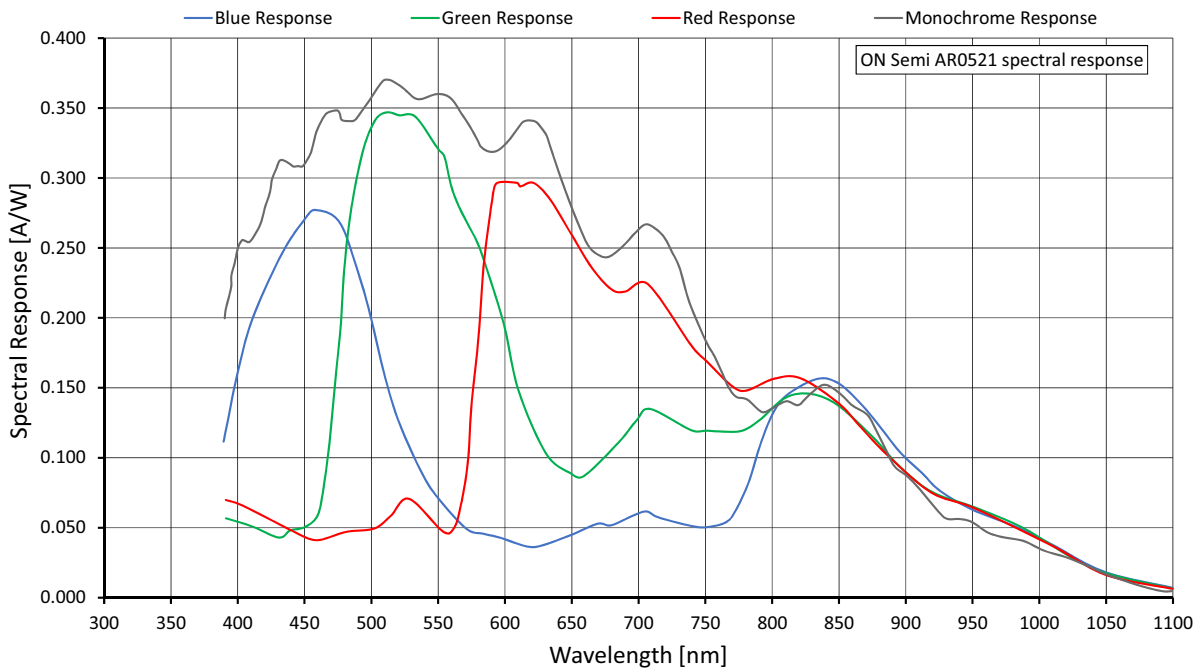

Figure 36: Alvim 1800 U-500m/c (ON Semi AR0521SR) spectral response

ROI frame rates

Values are based on the conditions defined in [Specified values](#) on page 77.

To reach the maximum frame rate available for this setup, the bandwidth for image traffic is 375 MByte/s. Increasing the `DeviceLinkThroughputLimit` value does not increase frame rates.

Shutter mode	User mode	Available frame rates
Rolling shutter (RS)	Freerun	Values in Table 54 below are reached.
Rolling shutter (RS)	Triggered	>50% of the values for in Table 54 below are reached.

Table 53: Frame rate behavior for different configurations

Image format	Width [pixels]	Height [pixels]	ROI area [MP]	Frame rate [fps] ¹		
				450 MByte/s	375 MByte/s	200 MByte/s
Full resolution	2592	1944	5.039	68.2/43.2	68.2/36.4	38.8/19.5
WQHD	2560	1440	3.686	91.1/58.5	91.1/49.4	52.6/26.4
QXGA	2048	1536	3.146	85.9/68.7	85.9/57.9	61.8/31.0
Full HD	1920	1080	2.074	120.6/102.9	120.6/86.9	92.6/46.5
UXGA	1600	1200	1.92	109.2/109.2	109.2/94.1	100.3/50.4
WXGA+	1440	900	1.296	143.9/143.9	143.9/137.9	143.9/73.9
SXGA	1280	1024	1.311	127.4/127.4		127.4/73.5
HD 720	1280	720	0.922	178.0/178.0		178.0/102.8
XGA	1024	768	0.786	167.9/167.9		167.9/120.8
SVGA	800	600	0.48	212.4/212.4		212.4/195.2
VGA	640	480	0.307	261.9/261.9		
HVGA	480	320	0.154	379.3/379.3		
QVGA	320	240	0.077	489.7/489.7		
HQVGA	240	160	0.038	687.5/687.5		
QQVGA	160	120	0.019	861.5/861.5		
Max. x half	2592	972	2.519	132.7/84.4	132.7/71.2	75.8/38.1
Max. x min.	2592	8	0.021	2194.0/1561.7	2194.0/1364.6	1428.2/787.8
Min. x max.	8	1944	0.016	68.7/68.7		
Min. x min.	8	8	64 Px	2956.0/2956.0		

¹ Mono8 or Bayer...8⁽²⁾ at `SensorBitDepth` = 10-Bit /
Mono10 or Bayer...10 at `SensorBitDepth` = 10-Bit

² The three dots... represent the colors of a Bayer pixel format, such as in BayerRG8.

Table 54: Alvium 1800 U-500m/c ROI frame rates

Alvium 1800 U-501m/c NIR

Feature	Specification	
	1800 U-501m NIR (monochrome)	1800 U-501c NIR (color)
Sensor model	ON Semiconductor AR0522	
Resolution	2592 (H) × 1944 (V); 5.0 MP	
Sensor type	CMOS	
Shutter type	Rolling shutter (RS)	
Sensor size	Type 1/2.5; 5.7 mm × 4.3 mm; 7.1 mm diagonal	
Pixel size	2.2 μm × 2.2 μm	
CRA	9 deg	
Sensor bit depth (ADC)	10-bit	
Monochrome pixel formats	Mono8 (default), Mono10, Mono10p, Mono12, Mono12p	Mono8, Mono10, Mono10p, Mono12, Mono12p
YUV color pixel formats	Not applicable	YCbCr411_8_CbYYCrYY, YCbCr422_8_CbYCrY, YCbCr8_CbYCr
RGB color pixel formats	Not applicable	BGR8, RGB8 (default)
Raw color pixel formats	Not applicable	BayerGR8, BayerGR10, BayerGR10p, BayerGR12, BayerGR12p
Maximum frame rate	68 fps ¹ (at ≥375 MByte/s)	
Exposure time	8 μs to 0.48 s (375 MByte/s)	
Exposure modes	Timed	
Gain	0 dB to 24.1 dB; 0.1 dB increments	
Digital binning	Horizontal: 1 to 8 columns; Vertical: 1 to 8 rows	
Sensor binning (H × V)	2 × 2 (<i>Sum</i>)	
Image buffer (RAM)	256 KByte	
Non-volatile memory (Flash)	1024 KByte	
GPIOs	4 programmable GPIOs As direct inputs (push-pull): 0 to 5.5 VDC As direct outputs (push-pull): 0 to 3.3 VDC at 12 mA	
Power requirements	Power over USB; External power	
Power consumption (typical at 5 VDC)	USB power: 2.2 W External power: 2.4 W	

¹ In triggered mode: ~34 fps

Table 55: Alvium 1800 U-501m/c NIR specifications (sheet 1 of 2)

Feature	Specification			
	1800 U-501m/c NIR (monochrome)			
Storage temperature	-20 °C to +85 °C ambient temperature			
Operating temperature	Hardware option	Housing	Cooling area²	Mainboard³
	Bare board ⁴	Not applicable	-20 °C to +85 °C	-20 °C to +85 °C
	Open housing ⁵	-20 °C to +65 °C		
	Closed housing	-20 °C to +65 °C	Not applicable	
Relative humidity	0% to 80% (non-condensing)			
Digital interface	Micro-B USB 3.1 Gen 1 interface			
Camera controls	GenICam (GenICam Access)			
² See Mounting the heat sink on page 272. ³ Output by <code>DeviceTemperature</code> ⁴ Ensure that the sensor is operated in the temperature range specified by the manufacturer. For any questions, please visit www.alliedvision.com/en/support . ⁵ Temperature values must be observed for the housing and for the cooling area.				

Table 55: Alvium 1800 U-501m/c NIR specifications (sheet 2 of 2)

Absolute QE

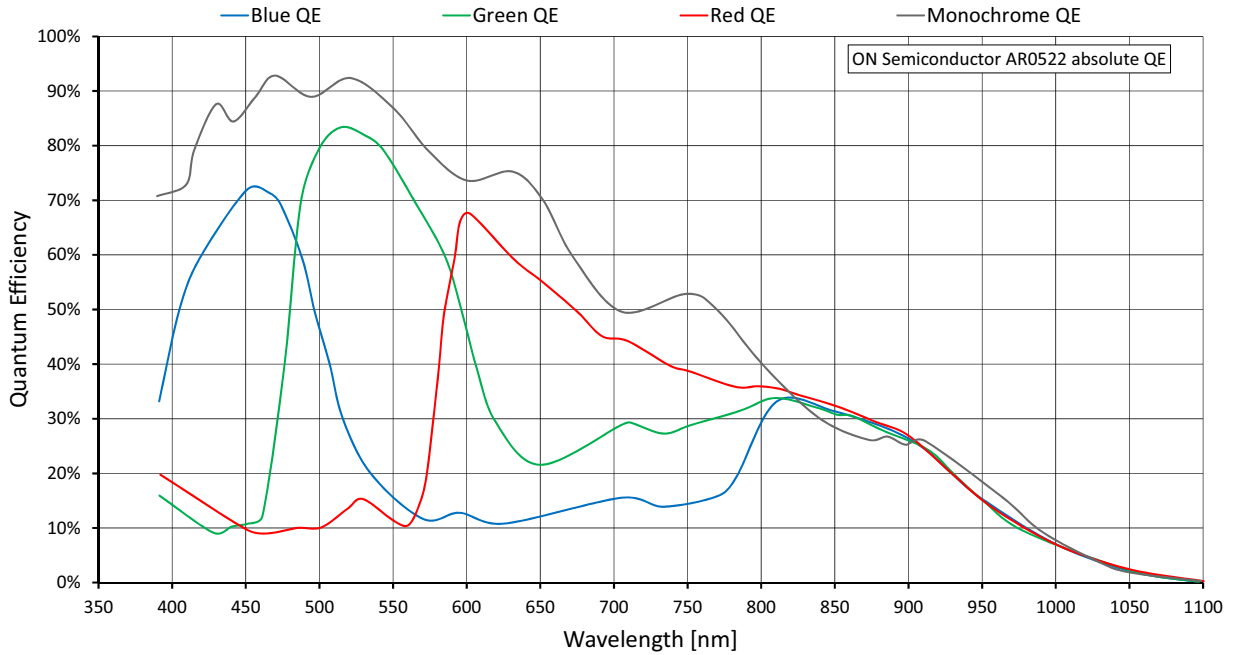

Figure 37: Alvium 1800 U-501m/c NIR (ON Semi AR0522) absolute QE

Spectral response

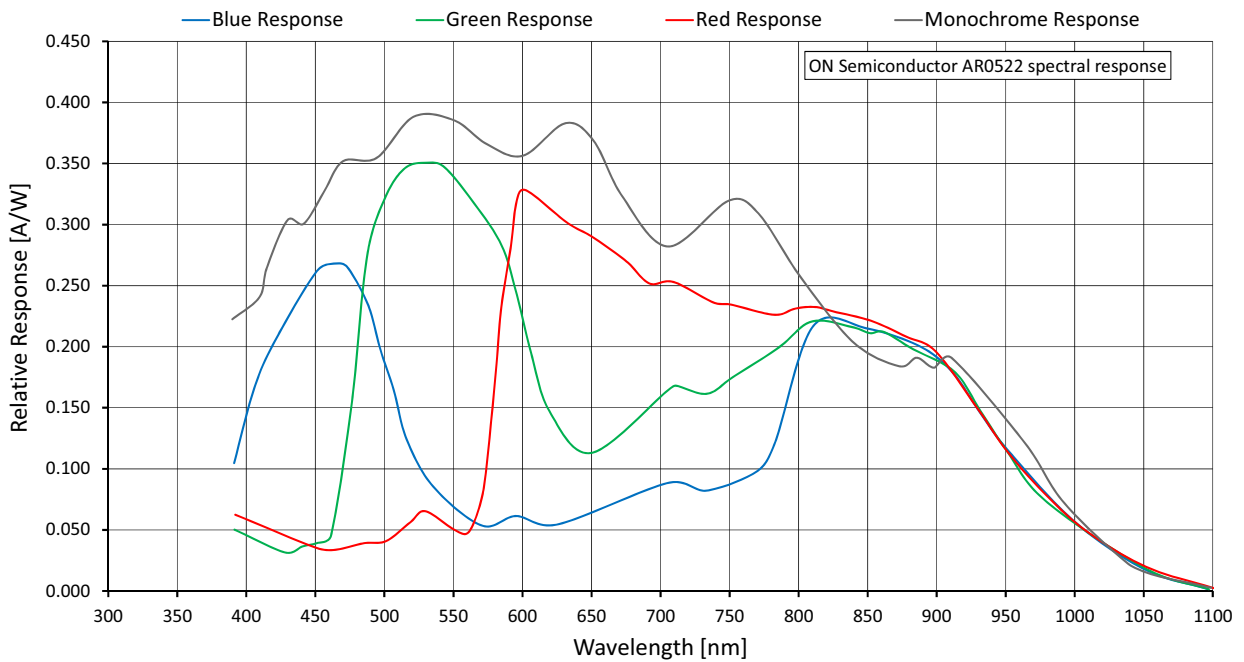

Figure 38: Alvium 1800 U-501m/c NIR (ON Semi AR0522) spectral response

ROI frame rates

Values are based on the conditions defined in [Specified values](#) on page 77.

To reach the maximum frame rate available for this setup, the bandwidth for image traffic is 375 MByte/s. Increasing the `DeviceLinkThroughputLimit` value does not increase frame rates.

Shutter mode	User mode	Available frame rates
Rolling shutter (RS)	Freerun	Values in Table 57 below are reached.
Rolling shutter (RS)	Triggered	>50% of the values for in Table 57 below are reached.

Table 56: Frame rate behavior for different configurations

Image format	Width [pixels]	Height [pixels]	ROI area [MP]	Frame rate [fps] ¹		
				450 MByte/s	375 MByte/s	200 MByte/s
Full resolution	2592	1944	5.039	68.2/43.2	68.2/36.4	38.8/19.5
WQHD	2560	1440	3.686	91.1/58.5	91.1/49.4	52.6/26.4
QXGA	2048	1536	3.146	85.9/68.7	85.9/57.9	61.8/31.0
Full HD	1920	1080	2.074	120.6/102.9	120.6/86.9	92.6/46.5
UXGA	1600	1200	1.92	109.2/109.2	109.2/94.1	100.3/50.4
WXGA+	1440	900	1.296	143.9/143.9	143.9/137.9	143.9/73.9
SXGA	1280	1024	1.311	127.4/127.4		127.4/73.5
HD 720	1280	720	0.922	178.0/178.0		178.0/102.8
XGA	1024	768	0.786	167.9/167.9		167.9/120.8
SVGA	800	600	0.48	212.4/212.4		212.4/195.2
VGA	640	480	0.307	261.9/261.9		
HVGA	480	320	0.154	379.3/379.3		
QVGA	320	240	0.077	489.7/489.7		
HQVGA	240	160	0.038	687.5/687.5		
QQVGA	160	120	0.019	861.5/861.5		
Max. x half	2592	972	2.519	132.7/84.4	132.7/71.2	75.8/38.1
Max. x min.	2592	8	0.021	2194.0/1561.7	2194.0/1364.6	1428.2/787.8
Min. x max.	8	1944	0.016	68.7/68.7		
Min. x min.	8	8	64 Px	2956.0/2956.0		

¹ Mono8 or Bayer...8⁽²⁾ at `SensorBitDepth` = 10-Bit /
Mono10 or Bayer...10 at `SensorBitDepth` = 10-Bit

² The three dots... represent the colors of a Bayer pixel format, such as in BayerRG8.

Table 57: Alvium 1800 U-501m/c NIR ROI frame rates

Alvium 1800 U-507m/c

Feature	Specification	
	1800 U-507m (monochrome)	1800 U-507c (color)
Sensor model	Sony IMX264	
Resolution	2464 (H) × 2056 (V); 5.1 MP	
Sensor type	CMOS	
Shutter type	Global shutter (GS)	
Sensor size	Type 2/3; 8.5 mm × 7.1 mm; 11.1 mm diagonal	
Pixel size	3.45 μm × 3.45 μm	
CRA	0 deg	
Sensor bit depth (ADC)	12-bit	
Monochrome pixel formats	Mono8 (default), Mono10, Mono10p, Mono12, Mono12p	Mono8, Mono10, Mono10p, Mono12, Mono12p
YUV color pixel formats	Not applicable	YCbCr411_8_CbYYCrYY, YCbCr422_8_CbYCrY, YCbCr8_CbYCr
RGB color pixel formats	Not applicable	BGR8, RGB8 (default)
Raw color pixel formats	Not applicable	BayerRG8, BayerRG10, BayerRG10p, BayerRG12, BayerRG12p
Maximum frame rate	34 fps (at ≥200 MByte/s)	
Exposure time	28 μs to 10 s (200 MByte/s)	
Exposure modes	Timed, TriggerControlled, TriggerWidth	
Gain	0 dB to 48 dB; 0.1 dB increments	
Digital binning	Horizontal: 1 to 8 columns; Vertical: 1 to 8 rows	
Multiple ROI (H × V)	<i>Free</i>	
Image buffer (RAM)	256 KByte	
Non-volatile memory (Flash)	1024 KByte	
GPIOs	4 programmable GPIOs As direct inputs (push-pull): 0 to 5.5 VDC As direct outputs (push-pull): 0 to 3.3 VDC at 12 mA	
Power requirements	Power over USB; External power	
Power consumption (typical, at 5 VDC)	USB power: 2.0 W External power: 2.2 W	

Table 58: Alvium 1800 U-507m/c specifications (sheet 1 of 2)

Feature	Specification			
	1800 U-507m/c			
Storage temperature	-20 °C to +85 °C ambient temperature			
Operating temperature	Hardware option	Housing	Cooling area¹	Mainboard²
	Bare board ³	Not applicable	-20 °C to +85 °C	-20 °C to +85 °C
	Open housing ⁴	-20 °C to +65 °C		
	Closed housing	-20 °C to +65 °C	Not applicable	
Relative humidity	0% to 80% (non-condensing)			
Digital interface	Micro-B USB 3.1 Gen 1 interface			
Camera controls	GenICam (GenICam Access)			
¹ See Mounting the heat sink on page 272. ² Output by <code>DeviceTemperature</code> ³ Ensure that the sensor is operated in the temperature range specified by the manufacturer. For any questions, please visit www.alliedvision.com/en/support . ⁴ Temperature values must be observed for the housing and for the cooling area.				

Table 58: Alvium 1800 U-507m/c specifications (sheet 2 of 2)

Absolute QE

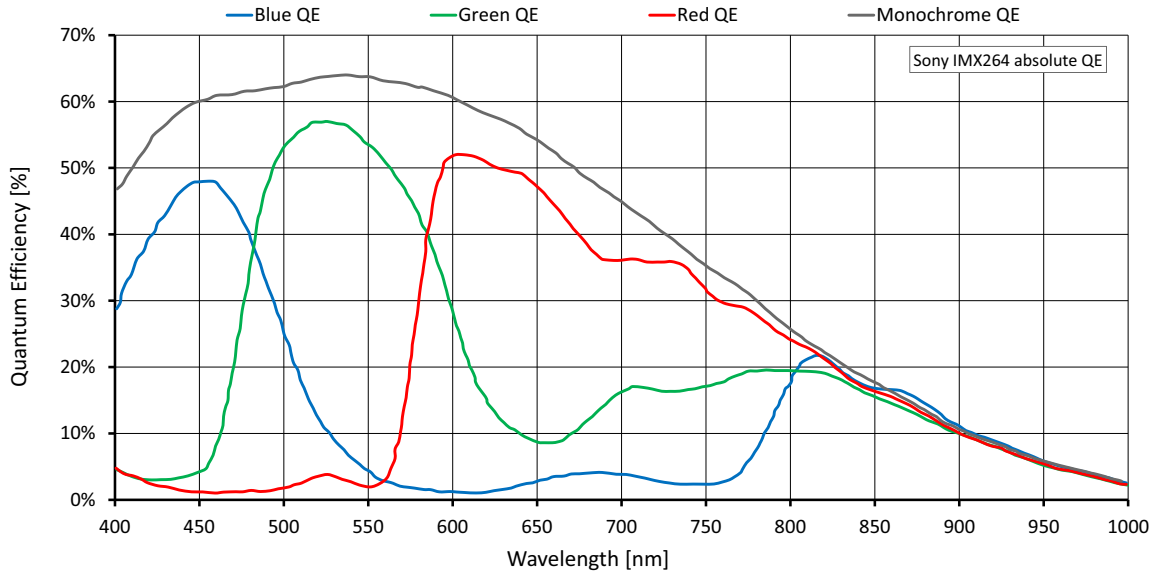

Figure 39: Alvim 1800 U-507m/c (Sony IMX264) absolute QE

Spectral response

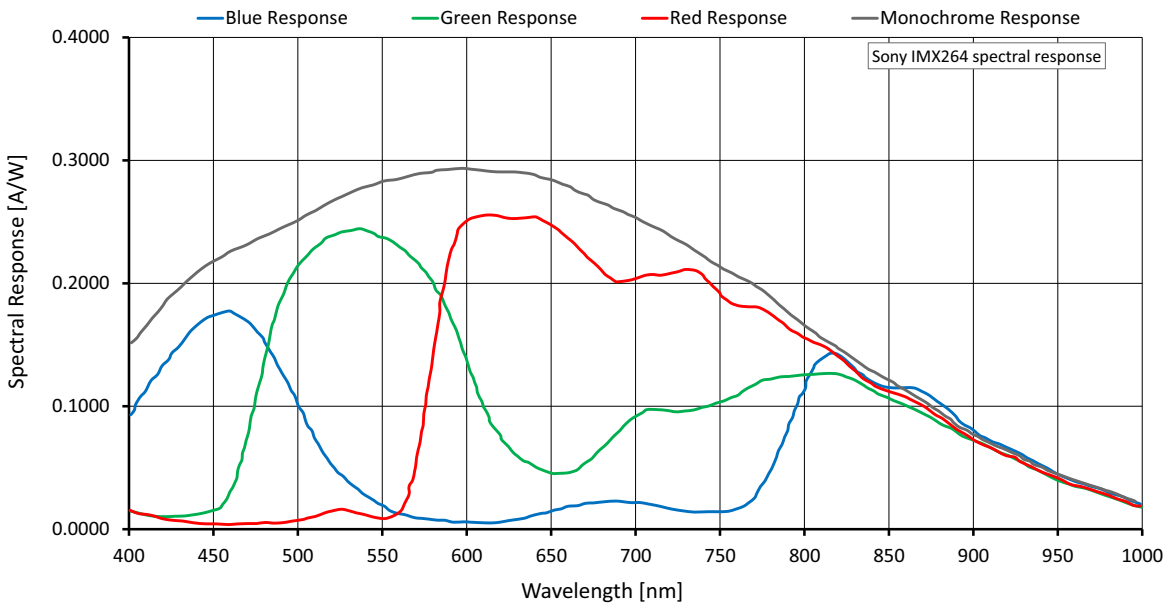

Figure 40: Alvim 1800 U-507m/c (Sony IMX264) spectral response

ROI frame rates

Values are based on the conditions defined in [Specified values](#) on page 77.

To reach the maximum frame rate available for this setup, the bandwidth for image traffic is 200 MByte/s. Increasing the `DeviceLinkThroughputLimit` value does not increase frame rates.

Image format	Width [pixels]	Height [pixels]	ROI area [MP]	Frame rate [fps] ¹		
				450 MByte/s	375 MByte/s	200 MByte/s
Full resolution	2464	2056	5.066	34.9/34.9		34.9/19.2
QXGA	2048	1536	3.146	46.4/46.4		46.4/30.6
Full HD	1920	1080	2.074	64.9/64.9		64.9/45.8
UXGA	1600	1200	1.92	58.9/58.9		58.9/49.8
WXGA+	1440	900	1.296	77.4/77.4		77.4/72.3
SXGA	1280	1024	1.311	68.6/68.6		68.6/68.6
HD 720	1280	720	0.922	95.5/95.5		
XGA	1024	768	0.786	90.1/90.1		
SVGA	800	600	0.48	113.7/113.7		
VGA	640	480	0.307	139.5/139.5		
HVGA	480	320	0.154	200.3/200.3		
QVGA	320	240	0.077	257.3/257.3		
HQVGA	240	160	0.038	356.3/356.3		
QQVGA	160	120	0.019	441.1/441.1		
Max. × half	2464	1028	2.533	67.8/67.8		67.8/37.4
Max. × min.	2464	8	0.02	1015.1/1015.1	1015.1/1015.1	1015.1/634.0
Min. × max.	8	2056	0.016	35.2/35.2		
Min. × min.	8	8	64 Px	1323.2/1323.2		

¹ Mono8 or Bayer...8⁽²⁾ at `SensorBitDepth` = 12-Bit⁽³⁾ / Mono12 or Bayer...12 at `SensorBitDepth` = 12-Bit

² The three dots... represent the colors of a Bayer pixel format, such as in BayerRG8.

Table 59: Alvim 1800 U-507m/c ROI frame rates

Alvium 1800 U-507m/c Pol



Please observe

For first series models, pixel processing has not been adjusted to enable the complete functionality available with non-polarizer models:

- Only raw pixel formats are supported, but no formats for polarizer sensors.
- Features based on pixel processing are available but cannot be used to generate a proper output. For example, color processing, binning, convolution filter, DPC, or FPNC are not supported.

Feature	Specification	
	1800 U-507m Pol (monochrome)	1800 U-507c Pol (color)
Sensor model	Sony IMX264MZR	Sony IMX264MYR
Resolution	2464 (H) × 2056 (V); 5.1 MP	
Sensor type	CMOS	
Shutter type	Global shutter (GS)	
Sensor size	Type 2/3; 8.5 mm × 7.1 mm; 11.1 mm diagonal	
Pixel size	3.45 μm × 3.45 μm	
CRA	0 deg	
Sensor bit depth (ADC)	12-bit	
Monochrome pixel formats	Mono8 (default), Mono10, Mono10p, Mono12, Mono12p	Not applicable
Raw color pixel formats	Not applicable	BayerRG8, BayerRG10, BayerRG10p, BayerRG12, BayerRG12p
Maximum frame rate	34 fps (at ≥200 MByte/s)	
Exposure time	28 μs to 10 s (200 MByte/s)	
Exposure modes	Timed, TriggerControlled, TriggerWidth	
Gain	0 dB to 48 dB; 0.1 dB increments	
Multiple ROI (H × V)	<i>Free</i>	
Image buffer (RAM)	256 KByte	
Non-volatile memory (Flash)	1024 KByte	
GPIOs	4 programmable GPIOs As direct inputs (push-pull): 0 to 5.5 VDC As direct outputs (push-pull): 0 to 3.3 VDC at 12 mA	
Power requirements	Power over USB; External power	
Power consumption (typical, at 5 VDC)	USB power: 2.0 W External power: 2.2 W	

Table 60: Alvium 1800 U-507m/c Pol specifications (sheet 1 of 2)

Feature	Specification			
	1800 U-507m/c			
Storage temperature	-20 °C to +85 °C ambient temperature			
Operating temperature	Hardware option	Housing	Cooling area¹	Mainboard²
	Bare board ³	Not applicable	-20 °C to +85 °C	-20 °C to +85 °C
	Open housing ⁴	-20 °C to +65 °C		
	Closed housing	-20 °C to +65 °C	Not applicable	
Relative humidity	0% to 80% (non-condensing)			
Digital interface	Micro-B USB 3.1 Gen 1 interface			
Camera controls	GenICam (GenICam Access)			
¹ See Mounting the heat sink on page 272. ² Output by <code>DeviceTemperature</code> ³ Ensure that the sensor is operated in the temperature range specified by the manufacturer. For any questions, please visit www.alliedvision.com/en/support . ⁴ Temperature values must be observed for the housing and for the cooling area.				

Table 60: Alvium 1800 U-507m/c Pol specifications (sheet 2 of 2)

Absolute QE, spectral response

We intend to add diagrams in a future version of this document.

ROI frame rates

Values are based on the conditions defined in [Specified values](#) on page 77.

To reach the maximum frame rate available for this setup, the bandwidth for image traffic is 200 MByte/s. Increasing the `DeviceLinkThroughputLimit` value does not increase frame rates.

Image format	Width [pixels]	Height [pixels]	ROI area [MP]	Frame rate [fps] ¹		
				450 MByte/s	375 MByte/s	200 MByte/s
Full resolution	2464	2056	5.066	34.9/34.9		34.9/19.2
QXGA	2048	1536	3.146	46.4/46.4		46.4/30.6
Full HD	1920	1080	2.074	64.9/64.9		64.9/45.8
UXGA	1600	1200	1.92	58.9/58.9		58.9/49.8
WXGA+	1440	900	1.296	77.4/77.4		77.4/72.3
SXGA	1280	1024	1.311	68.6/68.6		68.6/68.6
HD 720	1280	720	0.922	95.5/95.5		
XGA	1024	768	0.786	90.1/90.1		
SVGA	800	600	0.48	113.7/113.7		
VGA	640	480	0.307	139.5/139.5		
HVGA	480	320	0.154	200.3/200.3		
QVGA	320	240	0.077	257.3/257.3		
HQVGA	240	160	0.038	356.3/356.3		
QQVGA	160	120	0.019	441.1/441.1		
Max. × half	2464	1028	2.533	67.8/67.8		67.8/37.4
Max. × min.	2464	8	0.02	1015.1/1015.1	1015.1/1015.1	1015.1/634.0
Min. × max.	8	2056	0.016	35.2/35.2		
Min. × min.	8	8	64 Px	1323.2/1323.2		

¹ Mono8 or Bayer...8⁽²⁾ at `SensorBitDepth` = 12-Bit⁽³⁾ / Mono12 or Bayer...12 at `SensorBitDepth` = 12-Bit

² The three dots... represent the colors of a Bayer pixel format, such as in BayerRG8.

Table 61: Alvim 1800 U-507m/c Pol ROI frame rates

Alvium 1800 U-508m/c

Feature	Specification	
	1800 U-508m (monochrome)	1800 U-508c (color)
Sensor model	Sony IMX250	
Resolution	2464 (H) x 2056 (V); 5.1 MP	
Sensor type	CMOS	
Shutter type	Global shutter (GS)	
Sensor size	Type 2/3; 8.5 mm x 7.1 mm; 11.1 mm diagonal	
Pixel size	3.45 μm x 3.45 μm	
CRA	0 deg	
Sensor bit depth (ADC)	8-bit, 10-bit, 12-bit; Adaptive (10-bit, 12-bit)	
Monochrome pixel formats	Mono8 (default), Mono10, Mono10p, Mono12, Mono12p	Mono8, Mono10, Mono10p, Mono12, Mono12p
YUV color pixel formats	Not applicable	YCbCr411_8_CbYYCrYY, YCbCr422_8_CbYCrY, YCbCr8_CbYCr
RGB color pixel formats	Not applicable	BGR8, RGB8 (default)
Raw color pixel formats	Not applicable	BayerRG8, BayerRG10, BayerRG10p, BayerRG12, BayerRG12p
Maximum frame rate	84 fps (at 450 MByte/s)	
Exposure time	20 μs to 10 s (450 MByte/s)	
Exposure modes	Timed, TriggerControlled, TriggerWidth	
Gain	0 dB to 48 dB; 0.1 dB increments	
Digital binning	Horizontal: 1 to 8 columns; Vertical: 1 to 8 rows	
Sensor binning (H x V)	1 x 2 (<i>Sum</i>)	Not applicable
Multiple ROI (H x V)	<i>Free Tile Horizontal</i> : 1 x 1 to 1 x 4 <i>Vertical</i> : 1 x 1 to 1 x 4	
Image buffer (RAM)	256 KByte	
Non-volatile memory (Flash)	1024 KByte	
GPIOs	4 programmable GPIOs As direct inputs (push-pull): 0 to 5.5 VDC As direct outputs (push-pull): 0 to 3.3 VDC at 12 mA	
Power requirements	Power over USB; External power	
Power consumption (typical, at 5 VDC)	USB power: 2.9 W External power: 3.1 W	

Table 62: Alvium 1800 U-508m/c specifications (sheet 1 of 2)

Feature	Specification			
	1800 U-508m/c			
Storage temperature	-20 °C to +85 °C ambient temperature			
Operating temperature	Hardware option	Housing	Cooling area¹	Mainboard²
	Bare board ³	Not applicable	-20 °C to +85 °C	-20 °C to +85 °C
	Open housing ⁴	-20 °C to +65 °C		
	Closed housing	-20 °C to +65 °C	Not applicable	
Relative humidity	0% to 80% (non-condensing)			
Digital interface	Micro-B USB 3.1 Gen 1 interface			
Camera controls	GenICam (GenICam Access)			
¹ See Mounting the heat sink on page 272. ² Output by <code>DeviceTemperature</code> ³ Ensure that the sensor is operated in the temperature range specified by the manufacturer. For any questions, please visit www.alliedvision.com/en/support . ⁴ Temperature values must be observed for the housing and for the cooling area.				

Table 62: Alvium 1800 U-508m/c specifications (sheet 2 of 2)

Absolute QE

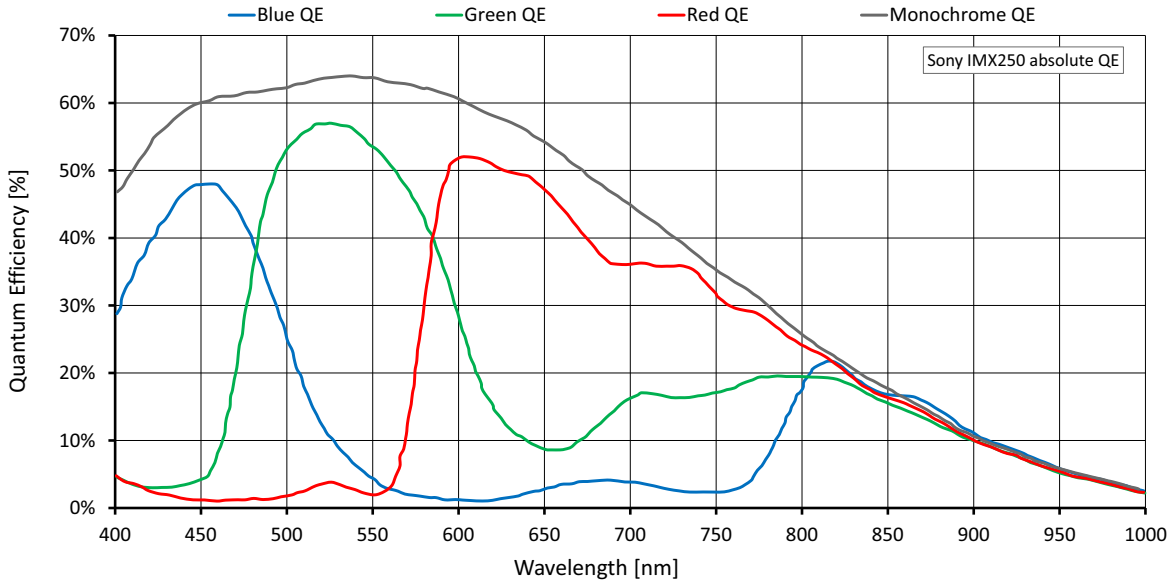

Figure 41: Alvium 1800 U-508m/c (Sony IMX250) absolute QE

Spectral response

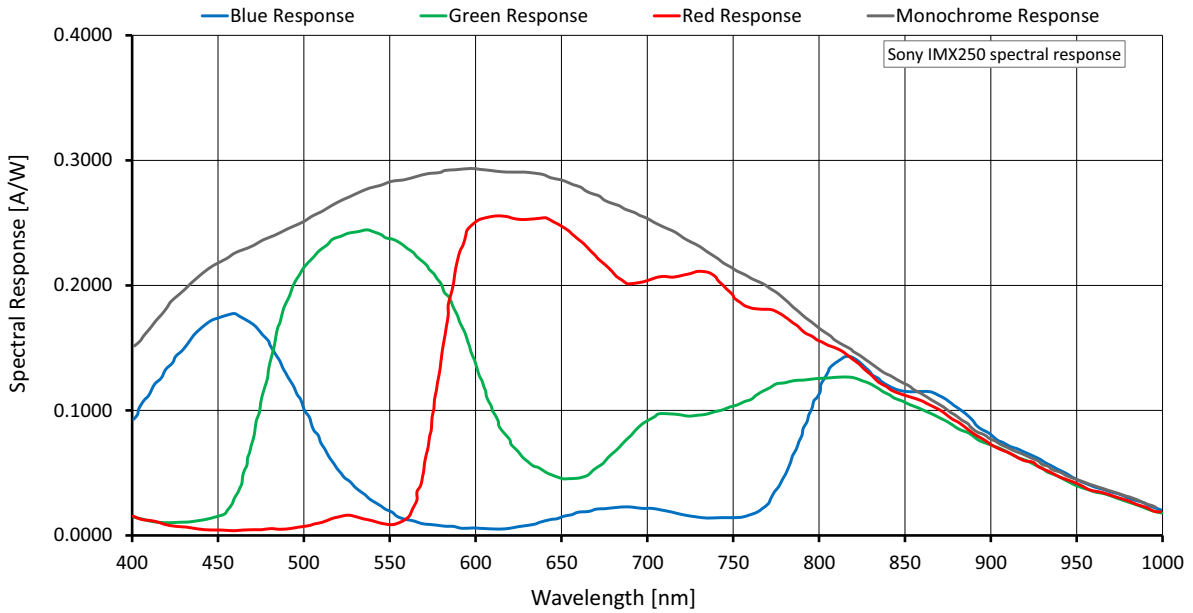

Figure 42: Alvium 1800 U-508m/c (Sony IMX250) spectral response

ROI frame rates

Values are based on the conditions defined in [Specified values](#) on page 77.

To reach the maximum frame rate available for this setup, the bandwidth for image traffic is 450 MByte/s.

Image format	Width [pixels]	Height [pixels]	ROI area [MP]	Frame rate [fps] ¹		
				450 MByte/s	375 MByte/s	200 MByte/s
Full resolution	2464	2056	5.066	84.2/42.3/42.4	71.3/35.7/35.7	38.2/19.2/19.2
QXGA	2048	1536	3.146	126.0/67.4/67.3	112.7/56.8/56.6	61.1/30.6/30.5
Full HD	1920	1080	2.074	175.8/100.8/100.0	166.8/85.2/84.7	90.6/45.8/45.6
UXGA	1600	1200	1.92	160.0/109.2/109.0	160.0/92.3/91.9	98.6/49.6/49.6
WXGA+	1440	900	1.296	209.9/159.3/146.2	209.9/134.7/134.2	143.7/72.4/72.0
SXGA	1280	1024	1.311	186.5/152.5/129.9	186.5/133.4/129.9	143.4/72.2/71.8
HD 720	1280	720	0.922	258.2/211.2/179.8	258.2/185.0/179.8	199.0/100.5/99.8
XGA	1024	768	0.786	244.9/200.1/170.6		234.6/118.3/117.7
SVGA	800	600	0.48	308.1/252.0/214.9		308.1/189.6/189.4
VGA	640	480	0.307	378.4/309.6/263.9		378.4/290.5/263.9
HVGA	480	320	0.154	541.1/443.8/377.3		
QVGA	320	240	0.077	686.8/567.5/483.8		
HQVGA	240	160	0.038	940.0/783.3/667.8		
QQVGA	160	120	0.019	1152.4/964.5/822.2		
Max. × half	2464	1028	2.533	161.9/81.9/81.9	137.4/69.2/69.1	74.2/37.4/37.3
Max. × min.	2464	8	0.02	1937.8/1139.2/ 1088.3	1748.8/1010.2/961.0	1125.8/614.7/596.7
Min. × max.	8	2056	0.016	96.5/79.1/67.4		
Min. × min.	8	8	64 Px	3138.1/2735.3/2331.8		

¹ Mono8 or Bayer...8⁽²⁾ at SensorBitDepth = 8-Bit⁽³⁾ /
 Mono10 or Bayer...10 at SensorBitDepth = 10-Bit /
 Mono12 or Bayer...12 at SensorBitDepth = 12-Bit

² The three dots... represent the colors of a Bayer pixel format, such as in BayerRG8.

³ The SensorBitDepth value must be set separately from PixelFormat.

See [Sensor ADC readout modes for maximum frame rates](#) on page 77 for details.

Table 63: Alvium 1800 U-508m/c ROI frame rates

Alvium 1800 U-508m/c Pol



Please observe

For first series models, pixel processing has not been adjusted to enable the complete functionality available with non-polarizer models:

- Only raw pixel formats are supported, but no formats for polarizer sensors.
- Features based on pixel processing are available but cannot be used to generate a proper output. For example, color processing, binning, convolution filter, DPC, or FPNC are not supported.

Feature	Specification	
	1800 U-508m Pol (monochrome)	1800 U-508c Pol (color)
Sensor model	Sony IMX250MZR	Sony IMX250MYR
Resolution	2464 (H) x 2056 (V); 5.1 MP	
Sensor type	CMOS	
Shutter type	Global shutter (GS)	
Sensor size	Type 2/3; 8.5 mm x 7.1 mm; 11.1 mm diagonal	
Pixel size	3.45 μm x 3.45 μm	
CRA	0 deg	
Sensor bit depth (ADC)	8-bit, 10-bit, 12-bit; Adaptive (10-bit, 12-bit)	
Monochrome pixel formats	Mono8 (default), Mono10, Mono10p, Mono12, Mono12p	Not applicable
Raw color pixel formats	Not applicable	BayerRG8, BayerRG10, BayerRG10p, BayerRG12, BayerRG12p
Maximum frame rate	84 fps (at 450 MByte/s)	
Exposure time	20 μs to 10 s (450 MByte/s)	
Exposure modes	Timed, TriggerControlled, TriggerWidth	
Gain	0 dB to 48 dB; 0.1 dB increments	
Multiple ROI (H x V)	<i>Free Tile Horizontal</i> : 1 x 1 to 1 x 4 <i>Vertical</i> : 1 x 1 to 1 x 4	
Image buffer (RAM)	256 KByte	
Non-volatile memory (Flash)	1024 KByte	
GPIOs	4 programmable GPIOs As direct inputs (push-pull): 0 to 5.5 VDC As direct outputs (push-pull): 0 to 3.3 VDC at 12 mA	
Power requirements	Power over USB; External power	
Power consumption (typical, at 5 VDC)	USB power: 2.9 W External power: 3.1 W	

Table 64: Alvium 1800 U-508m/c Pol specifications (sheet 1 of 2)

Feature	Specification			
	1800 U-508m/c			
Storage temperature	-20 °C to +85 °C ambient temperature			
Operating temperature	Hardware option	Housing	Cooling area¹	Mainboard²
	Bare board ³	Not applicable	-20 °C to +85 °C	-20 °C to +85 °C
	Open housing ⁴	-20 °C to +65 °C		
	Closed housing	-20 °C to +65 °C	Not applicable	
Relative humidity	0% to 80% (non-condensing)			
Digital interface	Micro-B USB 3.1 Gen 1 interface			
Camera controls	GenICam (GenICam Access)			
¹ See Mounting the heat sink on page 272. ² Output by <code>DeviceTemperature</code> ³ Ensure that the sensor is operated in the temperature range specified by the manufacturer. For any questions, please visit www.alliedvision.com/en/support . ⁴ Temperature values must be observed for the housing and for the cooling area.				

Table 64: Alvium 1800 U-508m/c Pol specifications (sheet 2 of 2)

Absolute QE, spectral response

We intend to add diagrams in a future version of this document.

ROI frame rates

Values are based on the conditions defined in [Specified values](#) on page 77.

To reach the maximum frame rate available for this setup, the bandwidth for image traffic is 450 MByte/s.

Image format	Width [pixels]	Height [pixels]	ROI area [MP]	Frame rate [fps] ¹		
				450 MByte/s	375 MByte/s	200 MByte/s
Full resolution	2464	2056	5.066	84.2/42.3/42.4	71.3/35.7/35.7	38.2/19.2/19.2
QXGA	2048	1536	3.146	126.0/67.4/67.3	112.7/56.8/56.6	61.1/30.6/30.5
Full HD	1920	1080	2.074	175.8/100.8/100.0	166.8/85.2/84.7	90.6/45.8/45.6
UXGA	1600	1200	1.92	160.0/109.2/109.0	160.0/92.3/91.9	98.6/49.6/49.6
WXGA+	1440	900	1.296	209.9/159.3/146.2	209.9/134.7/134.2	143.7/72.4/72.0
SXGA	1280	1024	1.311	186.5/152.5/129.9	186.5/133.4/129.9	143.4/72.2/71.8
HD 720	1280	720	0.922	258.2/211.2/179.8	258.2/185.0/179.8	199.0/100.5/99.8
XGA	1024	768	0.786	244.9/200.1/170.6		234.6/118.3/117.7
SVGA	800	600	0.48	308.1/252.0/214.9		308.1/189.6/189.4
VGA	640	480	0.307	378.4/309.6/263.9		378.4/290.5/263.9
HVGA	480	320	0.154	541.1/443.8/377.3		
QVGA	320	240	0.077	686.8/567.5/483.8		
HQVGA	240	160	0.038	940.0/783.3/667.8		
QQVGA	160	120	0.019	1152.4/964.5/822.2		
Max. × half	2464	1028	2.533	161.9/81.9/81.9	137.4/69.2/69.1	74.2/37.4/37.3
Max. × min.	2464	8	0.02	1937.8/1139.2/ 1088.3	1748.8/1010.2/961.0	1125.8/614.7/596.7
Min. × max.	8	2056	0.016	96.5/79.1/67.4		
Min. × min.	8	8	64 Px	3138.1/2735.3/2331.8		

¹ Mono8 or Bayer...8⁽²⁾ at SensorBitDepth = 8-Bit⁽³⁾ /
 Mono10 or Bayer...10 at SensorBitDepth = 10-Bit /
 Mono12 or Bayer...12 at SensorBitDepth = 12-Bit

² The three dots... represent the colors of a Bayer pixel format, such as in BayerRG8.

³ The SensorBitDepth value must be set separately from PixelFormat.

See [Sensor ADC readout modes for maximum frame rates](#) on page 77 for details.

Table 65: Alvium 1800 U-508m/c Pol ROI frame rates

Alvium 1800 U-510m/c

Feature	Specification	
	1800 U-510m (monochrome)	1800 U-510c (color)
Sensor model	Sony IMX548	
Resolution	2472 (H) × 2064 (V); 5.1 MP	
Sensor type	CMOS	
Shutter type	Global shutter (GS)	
Sensor size	Type 1/1.8; 6.8 mm × 5.7 mm; 8.8 mm diagonal	
Pixel size	2.74 μm × 2.74 μm	
CRA	0 deg	
Sensor bit depth (ADC)	12-bit	
Monochrome pixel formats	Mono8 (default), Mono10, Mono10p, Mono12, Mono12p	Mono8, Mono10, Mono10p, Mono12, Mono12p
YUV color pixel formats	Not applicable	YCbCr411_8_CbYYCrYY, YCbCr422_8_CbYCrY, YCbCr8_CbYCr
RGB color pixel formats	Not applicable	BGR8, RGB8 (default)
Raw color pixel formats	Not applicable	BayerRG8, BayerRG10, BayerRG10p, BayerRG12, BayerRG12p
Maximum frame rate	79 fps (at 450 MByte/s)	
Exposure time	8 μs to 10 s (450 MByte/s)	
Exposure modes	Timed	
Gain	0 dB to 48 dB; 0.1 dB increments	
Digital binning	Horizontal: 1 to 8 columns; Vertical: 1 to 8 rows	
Sensor binning (H × V)	2 × 2 (<i>Sum</i>)	Not applicable
Multiple ROI (H × V)	<i>Free Tile Horizontal</i> : 1 × 1 to 1 × 4 <i>Vertical</i> : 1 × 1 to 1 × 4	
Image buffer (RAM)	256 KByte	
Non-volatile memory (Flash)	1024 KByte	
GPIOs	4 programmable GPIOs As direct inputs (push-pull): 0 to 5.5 VDC As direct outputs (push-pull): 0 to 3.3 VDC at 12 mA	
Power requirements	Power over USB; External power	
Power consumption (typical, at 5 VDC)	USB power: 3.0 W External power: 3.2 W	

Table 66: Alvium 1800 U-510m/c specifications (sheet 1 of 2)

Feature	Specification			
	1800 U-510m/c			
Storage temperature	-20 °C to +85 °C ambient temperature			
Operating temperature	Hardware option	Housing	Cooling area¹	Mainboard²
	Bare board ³	Not applicable	-20 °C to +85 °C	-20 °C to +85 °C
	Open housing ⁴	-20 °C to +65 °C		
	Closed housing	-20 °C to +65 °C	Not applicable	
Relative humidity	0% to 80% (non-condensing)			
Digital interface	Micro-B USB 3.1 Gen 1 interface			
Camera controls	GenICam (GenICam Access)			
¹ See Mounting the heat sink on page 272. ² Output by <code>DeviceTemperature</code> ³ Ensure that the sensor is operated in the temperature range specified by the manufacturer. For any questions, please visit www.alliedvision.com/en/support . ⁴ Temperature values must be observed for the housing and for the cooling area.				

Table 66: Alvium 1800 U-510m/c specifications (sheet 2 of 2)

Absolute QE

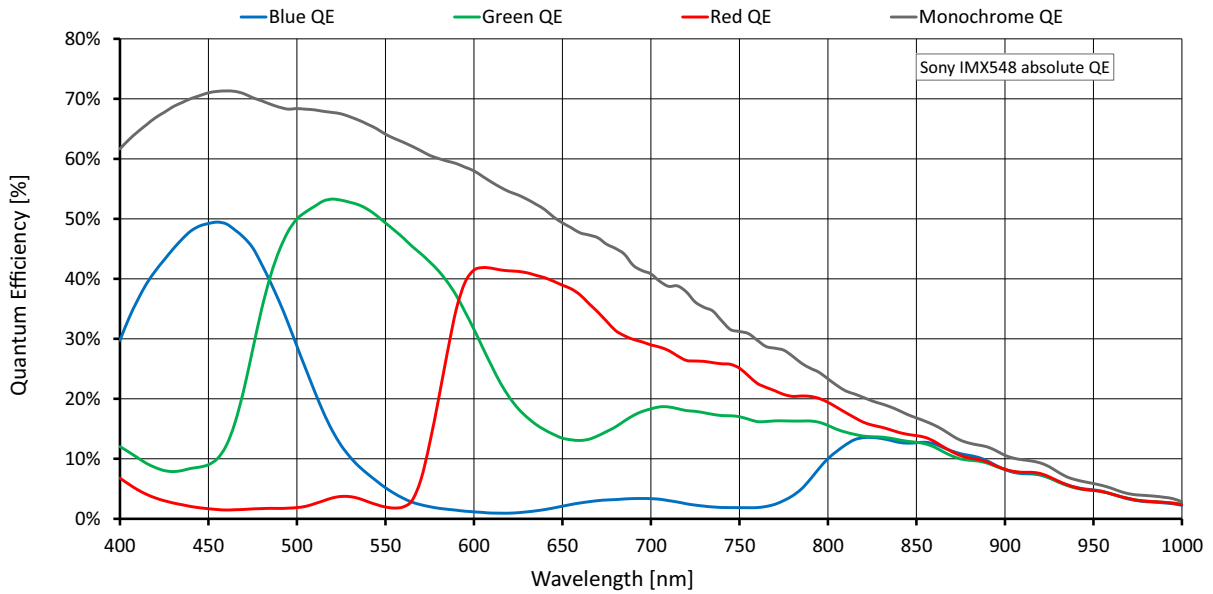

Figure 43: Alvium 1800 U-510m/c (Sony IMX548) absolute QE

Spectral response

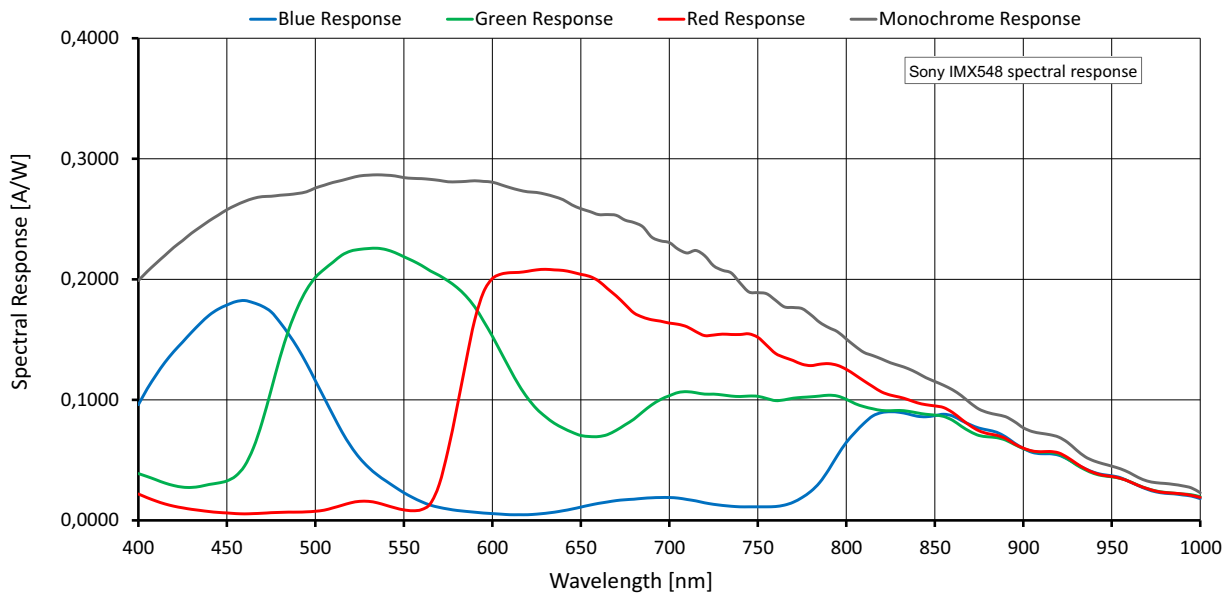

Figure 44: Alvium 1800 U-510m/c (Sony IMX548) spectral response

ROI frame rates

Values are based on the conditions defined in [Specified values](#) on page 77.

To reach the maximum frame rate available for this setup, the bandwidth for image traffic is 450 MByte/s.

Image format	Width [pixels]	Height [pixels]	ROI area [MP]	Frame rate [fps] ¹		
				450 MByte/s	375 MByte/s	200 MByte/s
Full resolution	2472	2064	5.102	79.9/40.3	67.1/33.9	36.1/18.2
QXGA	2048	1536	3.146	106.8/63.6	105.7/53.6	57.0/28.8
Full HD	1920	1080	2.074	145.5/92.7	145.5/78.2	83.0/41.9
UXGA	1600	1200	1.92	133.4/101.0	133.4/85.3	90.9/45.9
WXGA+	1440	900	1.296	170.2/143.8	170.2/121.0	129.0/65.0
SXGA	1280	1024	1.311	153.5/145.0	153.5/122.5	130.6/65.8
HD 720	1280	720	0.922	205.8/194.5	205.8/164.4	175.3/88.4
XGA	1024	768	0.786	195.9/195.9	195.9/194.2	195.9/105.1
SVGA	800	600	0.48	239.9/239.9		239.9/163.5
VGA	640	480	0.307	285.4/285.4		285.4/243.0
HVGA	480	320	0.154	380.5/380.5		380.5/340.8
QVGA	320	240	0.077	456.0/456.0		456.0/408.6
HQVGA	240	160	0.038	569.0/569.0		569.0/510.2
QQVGA	160	120	0.019	649.4/649.4		649.4/582.5
Max. × half	2472	1032	2.551	147.4/74.8	124.0/63.1	67.1/33.9
Max. × min.	2472	8	0.02	905.6/500.6	781.9/428.0	453.4/237.9
Min. × max.	8	2064	0.017	82.5/82.5		82.5/73.8
Min. × min.	8	8	64 Px	1074.8/1074.8		1074.8/966.3

¹ Mono8 or Bayer...8⁽²⁾ at SensorBitDepth = 12-Bit / Mono12 or Bayer...12 at SensorBitDepth = 12-Bit

² The three dots... represent the colors of a Bayer pixel format, such as in BayerRG8.

Table 67: Alvium 1800 U-510m/c ROI frame rates

Alvium 1800 U-511m/c

Feature	Specification	
	1800 U-511m (monochrome)	1800 U-511c (color)
Sensor model	Sony IMX547	
Resolution	2472 (H) × 2064 (V); 5.1 MP	
Sensor type	CMOS	
Shutter type	Global shutter (GS)	
Sensor size	Type 1/1.8; 6.8 mm × 5.7 mm; 8.8 mm diagonal	
Pixel size	2.74 μm × 2.74 μm	
CRA	0 deg	
Sensor bit depth (ADC)	12-bit	
Monochrome pixel formats	Mono8 (default), Mono10, Mono10p, Mono12, Mono12p	Mono8, Mono10, Mono10p, Mono12, Mono12p
YUV color pixel formats	Not applicable	YCbCr411_8_CbYYCrYY, YCbCr422_8_CbYCrY, YCbCr8_CbYCr
RGB color pixel formats	Not applicable	BGR8, RGB8 (default)
Raw color pixel formats	Not applicable	BayerRG8, BayerRG10, BayerRG10p, BayerRG12, BayerRG12p
Maximum frame rate	79 fps (at 450 MByte/s)	
Exposure time	8 μs to 10 s (450 MByte/s)	
Exposure modes	Timed, TriggerControlled, TriggerWidth	
Gain	0 dB to 48 dB; 0.1 dB increments	
Digital binning	Horizontal: 1 to 8 columns; Vertical: 1 to 8 rows	
Sensor binning (H × V)	2 × 2 (<i>Sum</i>)	Not applicable
Multiple ROI (H × V)	<i>Free Tile Horizontal</i> : 1 × 1 to 1 × 4 <i>Vertical</i> : 1 × 1 to 1 × 4	
Image buffer (RAM)	256 KByte	
Non-volatile memory (Flash)	1024 KByte	
GPIOs	4 programmable GPIOs As direct inputs (push-pull): 0 to 5.5 VDC As direct outputs (push-pull): 0 to 3.3 VDC at 12 mA	
Power requirements	Power over USB; External power	
Power consumption (typical, at 5 VDC)	USB power: 3.2 W External power: 3.4 W	

Table 68: Alvium 1800 U-511m/c specifications (sheet 1 of 2)

Feature	Specification			
	1800 U-511m/c			
Storage temperature	-20 °C to +85 °C ambient temperature			
Operating temperature	Hardware option	Housing	Cooling area¹	Mainboard²
	Bare board ³	Not applicable	-20 °C to +85 °C	-20 °C to +85 °C
	Open housing ⁴	-20 °C to +65 °C		
	Closed housing	-20 °C to +65 °C	Not applicable	
Relative humidity	0% to 80% (non-condensing)			
Digital interface	Micro-B USB 3.1 Gen 1 interface			
Camera controls	GenICam (GenICam Access)			
¹ See Mounting the heat sink on page 272. ² Output by <code>DeviceTemperature</code> ³ Ensure that the sensor is operated in the temperature range specified by the manufacturer. For any questions, please visit www.alliedvision.com/en/support . ⁴ Temperature values must be observed for the housing and for the cooling area.				

Table 68: Alvium 1800 U-511m/c specifications (sheet 2 of 2)

Absolute QE

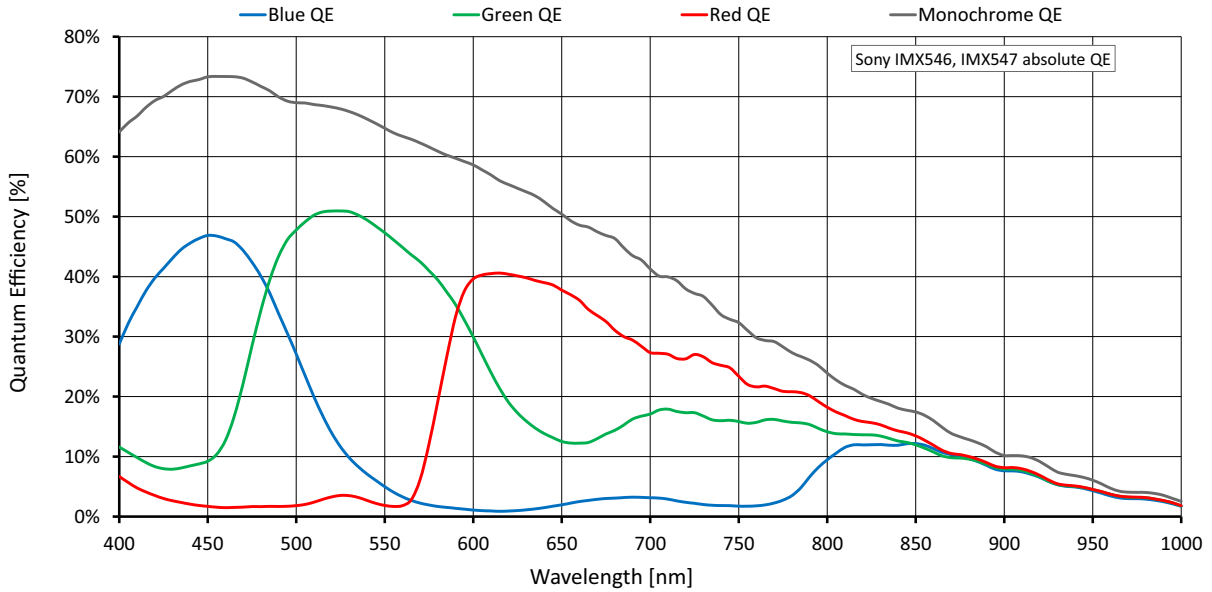

Figure 45: Alvium 1800 U-511m/c (Sony IMX547) absolute QE

Spectral response

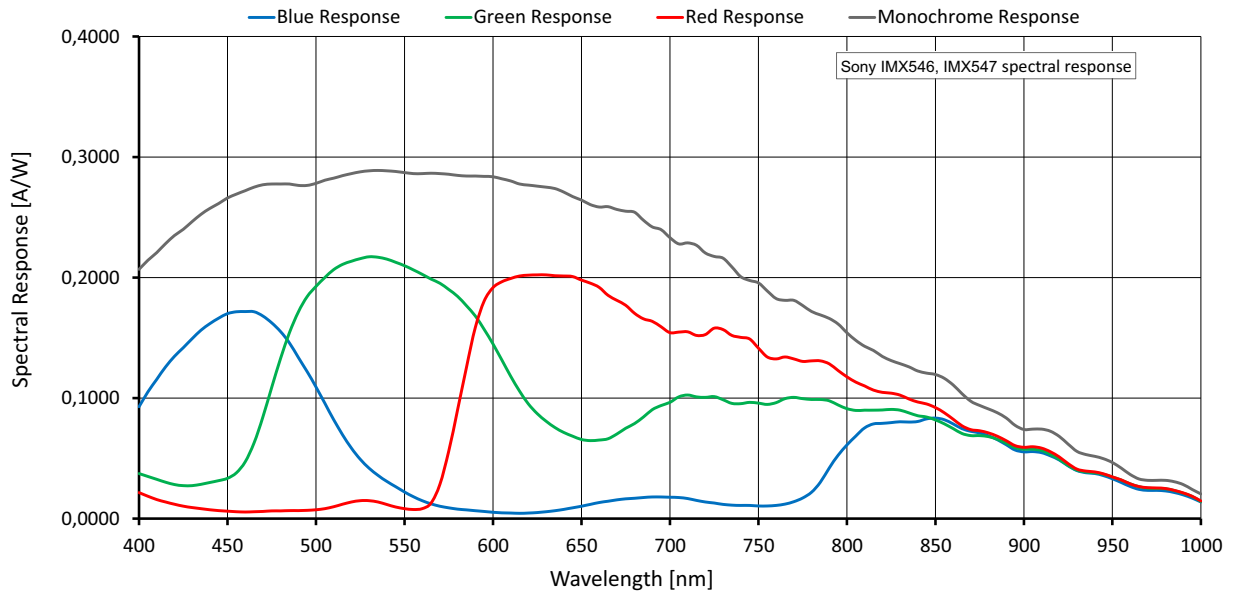

Figure 46: Alvium 1800 U-511m/c (Sony IMX547) spectral response

ROI frame rates

Values are based on the conditions defined in [Specified values](#) on page 77.

To reach the maximum frame rate available for this setup, the bandwidth for image traffic is 450 MByte/s.

Image format	Width [pixels]	Height [pixels]	ROI area [MP]	Frame rate [fps] ¹		
				450 MByte/s	375 MByte/s	200 MByte/s
Full resolution	2472	2064	5.102	79.9/40.3	67.1/33.9	36.1/18.2
QXGA	2048	1536	3.146	104.7/63.6	104.7/53.6	57.0/28.8
Full HD	1920	1080	2.074	142.7/92.7	142.7/78.2	83.0/41.9
UXGA	1600	1200	1.92	130.8/101.0	130.8/85.3	90.9/45.9
WXGA+	1440	900	1.296	167.0/143.8	167.0/121.0	129.0/65.0
SXGA	1280	1024	1.311	150.6/145.0	150.6/122.5	130.6/65.8
HD 720	1280	720	0.922	201.8/194.5	201.8/164.4	175.3/88.4
XGA	1024	768	0.786	192.3/192.3		192.3/105.0
SVGA	800	600	0.48	235.3/235.3		235.3/163.5
VGA	640	480	0.307	279.8/279.8		279.8/243.0
HVGA	480	320	0.154	373.1/373.1		373.1/340.8
QVGA	320	240	0.077	447.2/447.2		447.2/408.6
HQVGA	240	160	0.038	557.9/557.9		557.9/510.1
QQVGA	160	120	0.019	636.8/636.8		636.8/582.5
Max. × half	2472	1032	2.551	147.4/74.8	124.0/63.1	67.1/33.9
Max. × min.	2472	8	0.02	905.6/500.6	781.9/428.0	453.4/237.9
Min. × max.	8	2064	0.017	80.9/80.9	80.9/80.9	80.9/73.8
Min. × min.	8	8	64 Px	1053.9/1053.9	1053.9/1053.9	1053.9/966.3

¹ Mono8 or Bayer...8⁽²⁾ at SensorBitDepth = 12-Bit / Mono12 or Bayer...12 at SensorBitDepth = 12-Bit

² The three dots... represent the colors of a Bayer pixel format, such as in BayerRG8.

Table 69: Alvium 1800 U-511m/c ROI frame rates

Alvium 1800 U-530 VSWIR



Heat affecting your application

Image noise is increased by high operating temperatures, especially with Alvium VSWIR models. Therefore, we recommend you to optimize your SWIR application for heat dissipation. For more information on heat dissipation, see the Heat Dissipation for Housed Alvium CSI-2, USB, and G1 Cameras application note at www.alliedvision.com/en/support/technical-documentation/alvium-usb-documentation.

Feature	Specification
	1800 U-530 VSWIR
Sensor model	Sony IMX992
Resolution	2592(H) × 2056(V); 5.3 MP
Sensor type	InGaAs
Shutter type	Global shutter (GS)
Sensor size	Type 1/1.4; 8.9 mm × 7.1 mm; 11.4 mm diagonal
Pixel size	3.45 μm × 3.45 μm
CRA	0 deg
Sensor bit depth (ADC)	8-bit, 10-bit, 12-bit; Adaptive (10-bit, 12-bit)
Monochrome pixel formats	Mono8 (default), Mono10, Mono10p, Mono12, Mono12p
Maximum frame rate	77 fps (at 450 MByte/s)
Exposure time	38 μs to 10 s (450 MByte/s)
Exposure modes	Timed, TriggerControlled, TriggerWidth
Gain	0 dB to 42 dB; 0.1 dB increments
Digital binning	Horizontal: 1 to 8 columns; Vertical: 1 to 8 rows
Multiple ROI (H × V)	<i>Free Tile Horizontal: 1 × 1 to 1 × 4 Vertical: 1 × 1 to 1 × 4</i>
Image buffer (RAM)	256 KByte
Non-volatile memory (Flash)	1024 KByte
GPIOs	4 programmable GPIOs As direct inputs (push-pull): 0 to 5.5 VDC As direct outputs (push-pull): 0 to 3.3 VDC at 12 mA
Power requirements	Power over USB; External power
Power consumption (typical, at 5 VDC)	USB power: 2.9 W External power: 2.9 W

Table 70: Alvium 1800 U-530 VSWIR specifications (sheet 1 of 2)

Feature	Specification			
	1800 U-530 VSWIR			
Storage temperature	-20 °C to +85 °C ambient temperature			
Operating temperature	Hardware option	Housing	Cooling area¹	Mainboard²
	Bare board ³	Not applicable	-20 °C to +85 °C	-20 °C to +85 °C
	Open housing ⁴	-20 °C to +65 °C		
	Closed housing	-20 °C to +65 °C	Not applicable	
Relative humidity	0% to 80% (non-condensing)			
Digital interface	Micro-B USB 3.1 Gen 1 interface			
Camera controls	GenICam (GenICam Access)			

¹ See [Mounting the heat sink](#) on page 272.

² Output by `DeviceTemperature`

³ Ensure that the sensor is operated in the temperature range specified by the manufacturer. For any questions, please visit www.alliedvision.com/en/support.

⁴ Temperature values must be observed for the housing **and** for the cooling area.

Table 70: Alvium 1800 U-530 VSWIR specifications (sheet 2 of 2)

Absolute QE

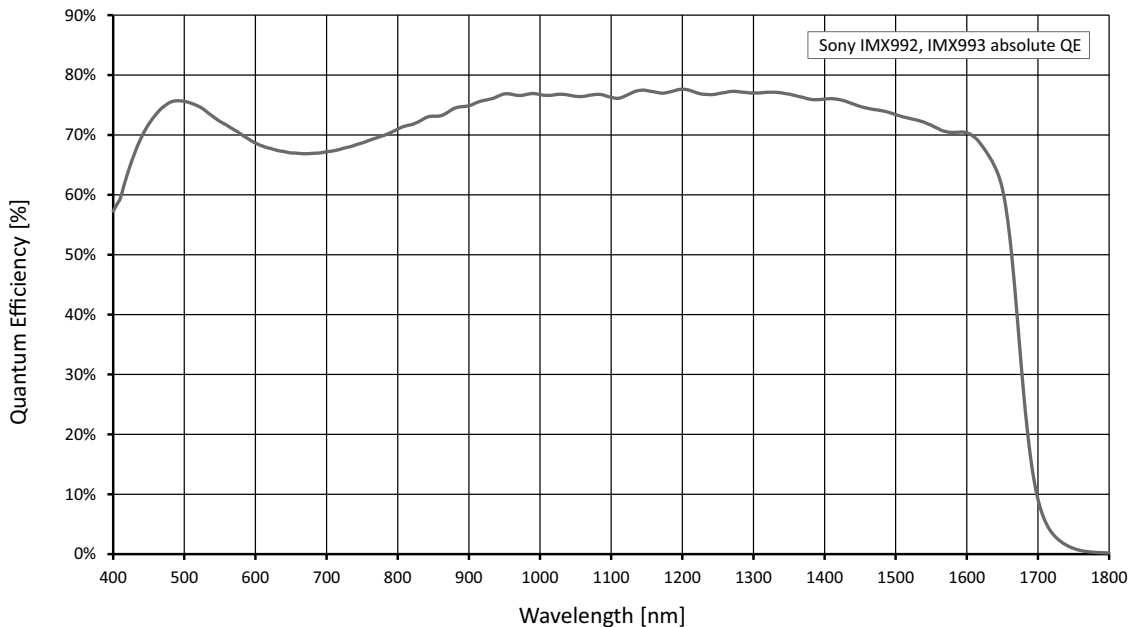

Figure 47: Alvium 1800 U-530 VSWIR (Sony IMX992) absolute QE
According to manufacturer data

ROI frame rates

Values are based on the conditions defined in [Specified values](#) on page 77.

To reach the maximum frame rate available for this setup, the bandwidth for image traffic is 450 MByte/s.

Image format	Width [pixels]	Height [pixels]	ROI area [MP]	Frame rate [fps] ¹		
				450 MByte/s	375 MByte/s	200 MByte/s
Full resolution	2592	2056	5,329	77.0/38.7/38.7	64.6/32.5/32.6	34.8/17.5/17.5
QSXGA	2560	2048	5,243	78.0/39.3/39.1	65.9/33.1/33.1	35.4/17.8/17.7
WQHD	2560	1440	3,686	107.3/54.2/53.9	90.7/45.7/45.7	48.9/24.6/24.5
QXGA	2048	1536	3,146	110.9/63.8/63.7	106.6/53.7/53.6	57.7/29.0/28.9
Full HD	1920	1080	2,074	151.5/93.3/92.7	151.5/78.9/78.4	83.9/42.4/42.2
UXGA	1600	1200	1,92	138.8/101.8/96.4	138.8/86.0/85.7	91.9/46.2/46.2
WXGA+	1440	900	1,296	177.5/145.0/123.3	177.5/122.5/122.1	130.7/65.8/65.5
SXGA	1280	1024	1,311	160.0/130.5/111.1	160.0/123.1/111.1	132.2/66.6/66.2
HD 720	1280	720	0,922	215.2/175.6/149.4	215.2/165.6/149.4	178.1/89.8/89.3
XGA	1024	768	0,786	205.0/167.4/142.3		205.0/106.4/105.9
SVGA	800	600	0,48	251.5/205.4/174.8		251.5/166.4/166.2
VGA	640	480	0,307	300.7/245.5/208.6		
HVGA	480	320	0,154	404.7/330.5/281.3		
QVGA	320	240	0,077	492.0/401.8/341.9		
HQVGA	240	160	0,038	623.1/508.8/433.1		
QQVGA	160	120	0,019	720.2/588.2/500.6		
Max. × half	2592	1028	2,665	142.2/71.8/71.7	119.6/60.5/60.6	64.8/32.6/32.6
Max. × min.	2592	8	0,021	929.0/502.0/491.1	803.9/431.7/423.2	469.6/244.1/240.9
Min. × max.	8	2056	0,016	86.3/70.4/59.9		
Min. × min.	8	8	64 Px	1279.8/1045.2/889.5		

¹ Mono8 at **SensorBitDepth** = 8-Bit⁽²⁾ / Mono10 at **SensorBitDepth** = 10-Bit / Mono12 or at **SensorBitDepth** = 12-Bit

² The **SensorBitDepth** value must be set separately from **PixelFormat**.
See [Sensor ADC readout modes for maximum frame rates](#) on page 77 for details.

Table 71: Alvium 1800 U-530 VSWIR ROI frame rates

Alvium 1800 U-811m/c

Feature	Specification	
	1800 U-811m (monochrome)	1800 U-811c (color)
Sensor model	Sony IMX546	
Resolution	2848 (H) × 2848 (V); 8.1 MP	
Sensor type	CMOS	
Shutter type	Global shutter (GS)	
Sensor size	Type 2/3; 7.8 mm × 7.8 mm; 11 mm diagonal	
Pixel size	2.74 μm × 2.74 μm	
CRA	0 deg	
Sensor bit depth (ADC)	12-bit	
Monochrome pixel formats	Mono8 (default), Mono10, Mono10p, Mono12, Mono12p	Mono8, Mono10, Mono10p, Mono12, Mono12p
YUV color pixel formats	Not applicable	YCbCr411_8_CbYYCrYY, YCbCr422_8_CbYCrY, YCbCr8_CbYCr
RGB color pixel formats	Not applicable	BGR8, RGB8 (default)
Raw color pixel formats	Not applicable	BayerRG8, BayerRG10, BayerRG10p, BayerRG12, BayerRG12p
Maximum frame rate	51 fps (at 450 MByte/s)	
Exposure time	9 μs to 10 s (450 MByte/s)	
Exposure modes	Timed, TriggerControlled, TriggerWidth	
Gain	0 dB to 48 dB; 0.1 dB increments	
Digital binning	Horizontal: 1 to 8 columns; Vertical: 1 to 8 rows	
Sensor binning (H × V)	2 × 2 (<i>Sum</i>)	Not applicable
Multiple ROI (H × V)	<i>Free Tile Horizontal</i> : 1 × 1 to 1 × 4 <i>Vertical</i> : 1 × 1 to 1 × 4	
Image buffer (RAM)	256 KByte	
Non-volatile memory (Flash)	1024 KByte	
GPIOs	4 programmable GPIOs As direct inputs (push-pull): 0 to 5.5 VDC As direct outputs (push-pull): 0 to 3.3 VDC at 12 mA	
Power requirements	Power over USB; External power	
Power consumption (typical, at 5 VDC)	USB power: 3.3 W External power: 3.5 W	

Table 72: Alvium 1800 U-811m/c specifications (sheet 1 of 2)

Feature	Specification			
	1800 U-811m/c			
Storage temperature	-20 °C to +85 °C ambient temperature			
Operating temperature	Hardware option	Housing	Cooling area¹	Mainboard²
	Bare board ³	Not applicable	-20 °C to +85 °C	-20 °C to +85 °C
	Open housing ⁴	-20 °C to +65 °C		
	Closed housing	-20 °C to +65 °C	Not applicable	
Relative humidity	0% to 80% (non-condensing)			
Digital interface	Micro-B USB 3.1 Gen 1 interface			
Camera controls	GenICam (GenICam Access)			
¹ See Mounting the heat sink on page 272. ² Output by <code>DeviceTemperature</code> ³ Ensure that the sensor is operated in the temperature range specified by the manufacturer. For any questions, please visit www.alliedvision.com/en/support . ⁴ Temperature values must be observed for the housing and for the cooling area.				

Table 72: Alvium 1800 U-811m/c specifications (sheet 2 of 2)

Absolute QE

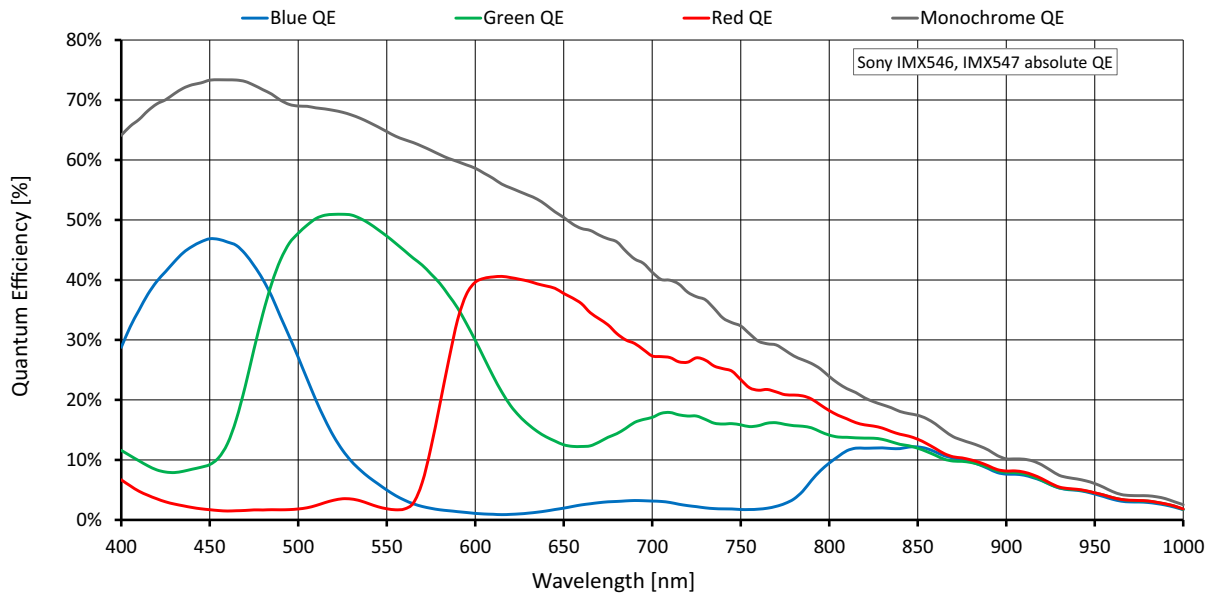

Figure 48: Alvium 1800 U-811m/c (Sony IMX546) absolute QE

Spectral response

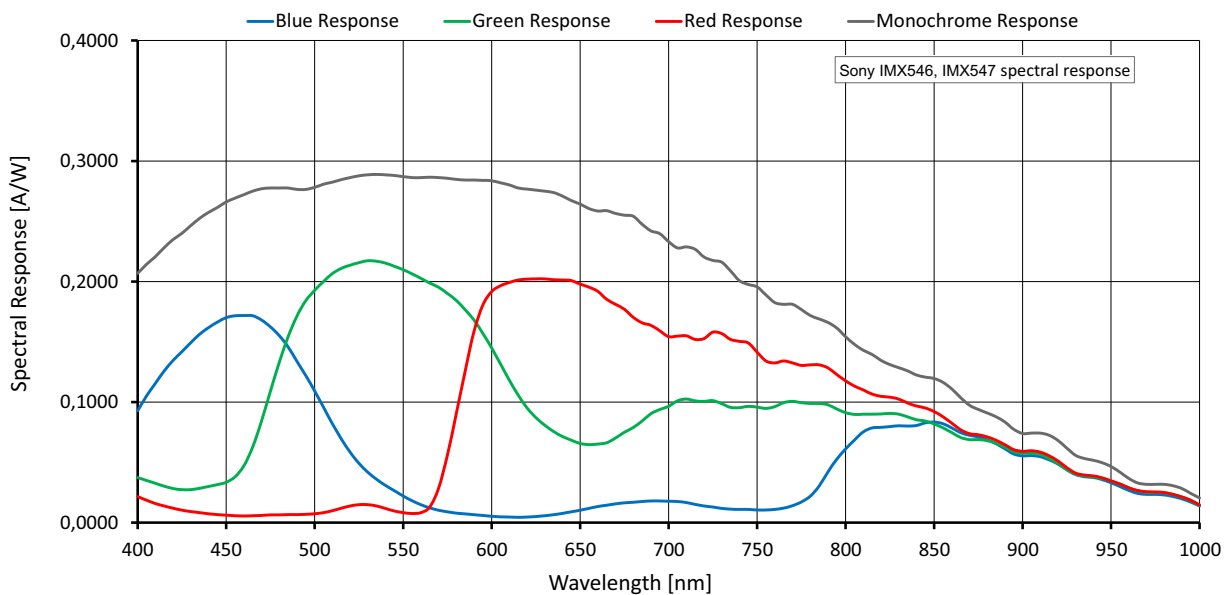

Figure 49: Alvium 1800 U-811m/c (Sony IMX546) spectral response

ROI frame rates

Values are based on the conditions defined in [Specified values](#) on page 77.

To reach the maximum frame rate available for this setup, the bandwidth for image traffic is 450 MByte/s.

Image format	Width [pixels]	Height [pixels]	ROI area [MP]	Frame rate [fps] ¹		
				450 MByte/s	375 MByte/s	200 MByte/s
Full resolution	2848	2848	8.111	51.3/25.8	43.4/21.8	23.2/11.7
QSXGA	2560	2048	5.243	77.5/39.1	65.5/33.0	35.2/17.7
WQHD	2560	1440	3.686	106.4/53.8	89.9/45.4	48.4/24.4
QXGA	2048	1536	3.146	104.7/63.6	104.7/53.6	57.0/28.8
Full HD	1920	1080	2.074	142.7/92.7	142.7/78.2	83.0/41.9
UXGA	1600	1200	1.92	130.8/101.0	130.8/85.3	90.9/45.9
WXGA+	1440	900	1.296	167.0/143.8	167.0/121.0	129.0/65.0
SXGA	1280	1024	1.311	150.6/145.0	150.6/122.5	130.6/65.8
HD 720	1280	720	0.922	201.8/194.5	201.8/164.4	175.3/88.4
XGA	1024	768	0.786	192.3/192.3		192.3/105.1
SVGA	800	600	0.48	235.3/235.3		235.3/163.5
VGA	640	480	0.307	279.8/279.8		279.8/243.0
HVGA	480	320	0.154	373.1/373.1		373.1/340.8
QVGA	320	240	0.077	447.2/447.2		447.2/408.6
HQVGA	240	160	0.038	558.0/557.9		557.9/510.2
QQVGA	160	120	0.019	636.8/636.8		636.8/582.5
Max. × half	2848	1424	4.056	96.6/48.9	81.8/41.3	43.9/22.1
Max. × min.	2848	8	0.023	783.9/433.3	682.1/371.9	393.5/206.4
Min. × max.	8	2848	0.023	59.9/59.9		59.9/54.6
Min. × min.	8	8	64 Px	1053.9/1053.9		1053.9/966.3

¹ Mono8 or Bayer...8⁽²⁾ at SensorBitDepth = 12-Bit / Mono12 or Bayer...12 at SensorBitDepth = 12-Bit

² The three dots... represent the colors of a Bayer pixel format, such as in BayerRG8.

Table 73: Alvium 1800 U-811m/c ROI frame rates

Alvium 1800 U-812 UV



NOTICE

Sensor aging by UV radiation

The sensor in this camera model is dedicated for imaging in the UV spectrum. However, UV radiation causes aging, which is permanently increasing the dark current and decreasing the QE (quantum efficiency).

To reduce sensor aging, we recommend you to:

- Minimize the intensity of UV radiation.
- Avoid wavelengths below 250 nm. For example, consider the use of bandpass filters to block shorter wavelengths.

Feature	Specification	
	1800 U-812 (monochrome)	
Sensor model	Sony IMX487	
Resolution	2848 (H) × 2848 (V); 8.1 MP	
Sensor type	CMOS	
Shutter type	Global shutter (GS)	
Sensor size	Type 2/3; 7.8 mm × 7.8 mm; 11 mm diagonal	
Pixel size	2.74 μm × 2.74 μm	
CRA	0 deg	
Sensor bit depth (ADC)	12-bit	
Monochrome pixel formats	Mono8 (default), Mono10, Mono10p, Mono12, Mono12p	
Maximum frame rate	51 fps (at 450 MByte/s)	
Exposure time	9 μs to 10 s (450 MByte/s)	
Exposure modes	Timed, TriggerControlled, TriggerWidth	
Gain	0 dB to 48 dB; 0.1 dB increments	
Digital binning	Horizontal: 1 to 8 columns; Vertical: 1 to 8 rows	
Sensor binning (H × V)	2 × 2 (<i>Sum</i>)	Not applicable
Multiple ROI (H × V)	<i>Free Tile Horizontal</i> : 1 × 1 to 1 × 4 <i>Vertical</i> : 1 × 1 to 1 × 4	
Image buffer (RAM)	256 KByte	
Non-volatile memory (Flash)	1024 KByte	
GPIOs	4 programmable GPIOs	
	As direct inputs (push-pull): 0 to 5.5 VDC As direct outputs (push-pull): 0 to 3.3 VDC at 12 mA	
Power requirements	Power over USB; External power	
Power consumption (typical, at 5 VDC)	USB power: 3.9 W	
	External power: 4.1 W	

Table 74: Alvium 1800 U-812 UV specifications (sheet 1 of 2)

Feature	Specification			
	1800 U-812 UV			
Storage temperature	-20 °C to +85 °C ambient temperature			
Operating temperature	Hardware option	Housing	Cooling area¹	Mainboard²
	Bare board ³	Not applicable	-20 °C to +85 °C	-20 °C to +85 °C
	Open housing ⁴	-20 °C to +65 °C		
	Closed housing	-20 °C to +65 °C	Not applicable	
Relative humidity	0% to 80% (non-condensing)			
Digital interface	Micro-B USB 3.1 Gen 1 interface			
Camera controls	GenICam (GenICam Access)			

¹ See [Mounting the heat sink](#) on page 272.

² Output by `DeviceTemperature`

³ Ensure that the sensor is operated in the temperature range specified by the manufacturer. For any questions, please visit www.alliedvision.com/en/support.

⁴ Temperature values must be observed for the housing **and** for the cooling area.

Table 74: Alvium 1800 U-812 UV specifications (sheet 2 of 2)

Absolute QE

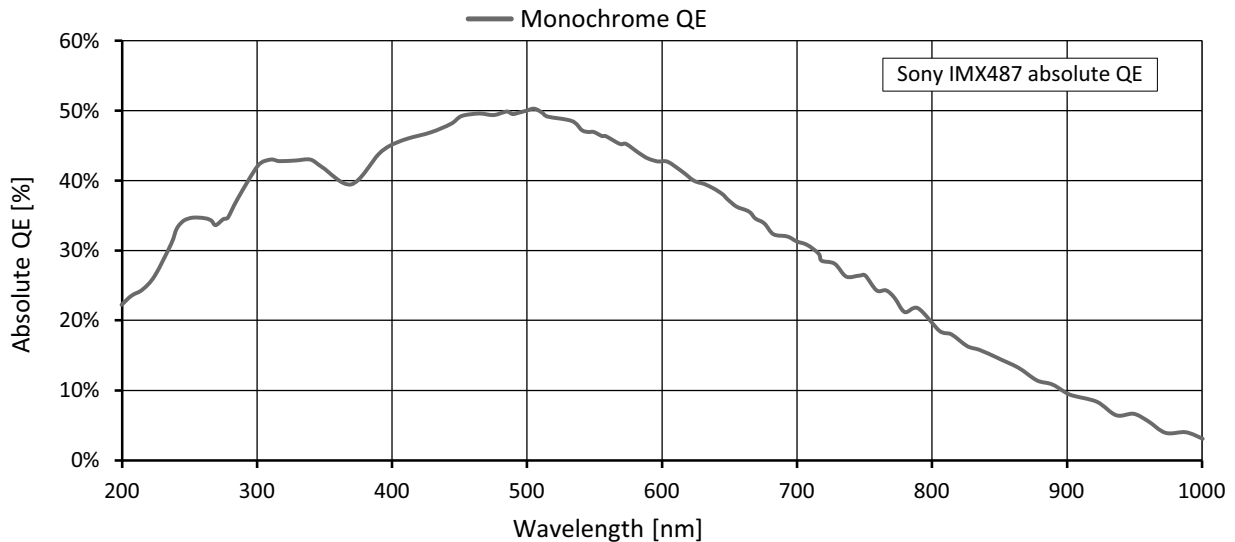

Figure 50: Alvium 1800 U-812 UV (Sony IMX487) absolute QE

ROI frame rates

Values are based on the conditions defined in [Specified values](#) on page 77.

To reach the maximum frame rate available for this setup, the bandwidth for image traffic is 450 MByte/s.

Image format	Width [pixels]	Height [pixels]	ROI area [MP]	Frame rate [fps] ¹		
				450 MByte/s	375 MByte/s	200 MByte/s
Full resolution	2848	2848	8.111	51.0/25.7	43.1/21.7	23.1/11.6
QSXGA	2560	2048	5.243	76.8/38.7	64.9/32.7	34.8/17.5
WQHD	2560	1440	3.686	105.1/53.1	88.9/44.9	47.8/24.1
QXGA	2048	1536	3.146	103.5/62.8	103.5/53.0	56.3/28.4
Full HD	1920	1080	2.074	139.6/90.6	139.6/76.5	81.1/40.9
UXGA	1600	1200	1.92	128.9/99.5	128.9/84.0	89.6/45.2
WXGA+	1440	900	1.296	162.8/140.1	162.8/117.9	125.7/63.3
SXGA	1280	1024	1.311	148.1/142.7	148.1/120.5	128.5/64.7
HD 720	1280	720	0.922	197.4/190.2	197.4/160.8	171.4/86.5
XGA	1024	768	0.786	188.3/188.3		188.3/102.8
SVGA	800	600	0.48	227.0/227.0		227.0/157.7
VGA	640	480	0.307	271.4/271.4		271.4/235.6
HVGA	480	320	0.154	358.3/358.3		358.3/327.2
QVGA	320	240	0.077	426.0/426.0		426.0/389.3
HQVGA	240	160	0.038	525.4/525.4		525.4/480.3
QQVGA	160	120	0.019	579.5/579.5		579.5/529.9
Max. x half	2848	1424	4.056	95.4/48.3	80.8/40.8	43.4/21.8
Max. x min.	2848	8	0.023	687.2/375.0	595.7/321.1	340.0/177.2
Min. x max.	8	2848	0.023	59.5/59.5		59.5/54.2
Min. x min.	8	8	64 Px	905.6/905.6		905.6/829.6

¹ Mono8 or Bayer...8⁽²⁾ at **SensorBitDepth** = 12-Bit /
Mono12 or Bayer...12 at **SensorBitDepth** = 12-Bit

² The three dots... represent the colors of a Bayer pixel format, such as in Bayer**RG8**.

Table 75: Alvium 1800 U-812 UV ROI frame rates

Alvium 1800 U-895m/c

Feature	Specification	
	1800 U-895m (monochrome)	1800 U-895c (color)
Sensor model	Sony IMX267	
Resolution	4112 (H) × 2176 (V); 8.95 MP	
Sensor type	CMOS	
Shutter type	Global shutter (GS)	
Sensor size	Type 1; 14.2 mm × 7.5 mm; 16.0 mm diagonal	
Pixel size	3.45 μm × 3.45 μm	
CRA	0 deg	
Sensor bit depth (ADC)	12-bit	
Monochrome pixel formats	Mono8 (default), Mono10, Mono10p, Mono12, Mono12p	Mono8, Mono10, Mono10p, Mono12, Mono12p
YUV color pixel formats	Not applicable	YCbCr411_8_CbYYCrYY, YCbCr422_8_CbYCrY, YCbCr8_CbYCr
RGB color pixel formats	Not applicable	BGR8, RGB8 (default)
Raw color pixel formats	Not applicable	BayerRG8, BayerRG10, BayerRG10p, BayerRG12, BayerRG12p
Maximum frame rate	31 fps (at ≥375 MByte/s)	
Exposure time	29 μs to 10 s (375 MByte/s)	
Exposure modes	Timed, TriggerControlled, TriggerWidth	
Gain	0 dB to 48 dB; 0.1 dB increments	
Digital binning ¹	Horizontal: 1 to 8 columns; Vertical: 1 to 8 rows	
Multiple ROI (H × V)	<i>Free</i>	
Image buffer (RAM)	256 KByte	
Non-volatile memory (Flash)	1024 KByte	
GPIOs	4 programmable GPIOs As direct inputs (push-pull): 0 to 5.5 VDC As direct outputs (push-pull): 0 to 3.3 VDC at 12 mA	
Power requirements	Power over USB; External power	
Power consumption (typical, at 5 VDC)	USB power: 2.8 W External power: 2.8 W	

¹ Digital vertical binning can be used only when digital horizontal binning is used as well.

Table 76: Alvium 1800 U-895m/c specifications (sheet 1 of 2)

Feature	Specification			
	1800 U-895m/c			
Storage temperature	-20 °C to +85 °C ambient temperature			
Operating temperature	Hardware option	Housing	Cooling area¹	Mainboard²
	Bare board ³	Not applicable	-20 °C to +85 °C	-20 °C to +85 °C
	Open housing ⁴	-20 °C to +65 °C		
	Closed housing	-20 °C to +65 °C	Not applicable	
Relative humidity	0% to 80% (non-condensing)			
Digital interface	Micro-B USB 3.1 Gen 1 interface			
Camera controls	GenICam (GenICam Access)			
¹ See Mounting the heat sink on page 272. ² Output by <code>DeviceTemperature</code> ³ Ensure that the sensor is operated in the temperature range specified by the manufacturer. For any questions, please visit www.alliedvision.com/en/support . ⁴ Temperature values must be observed for the housing and for the cooling area.				

Table 76: Alvium 1800 U-895m/c specifications (sheet 2 of 2)

Absolute QE

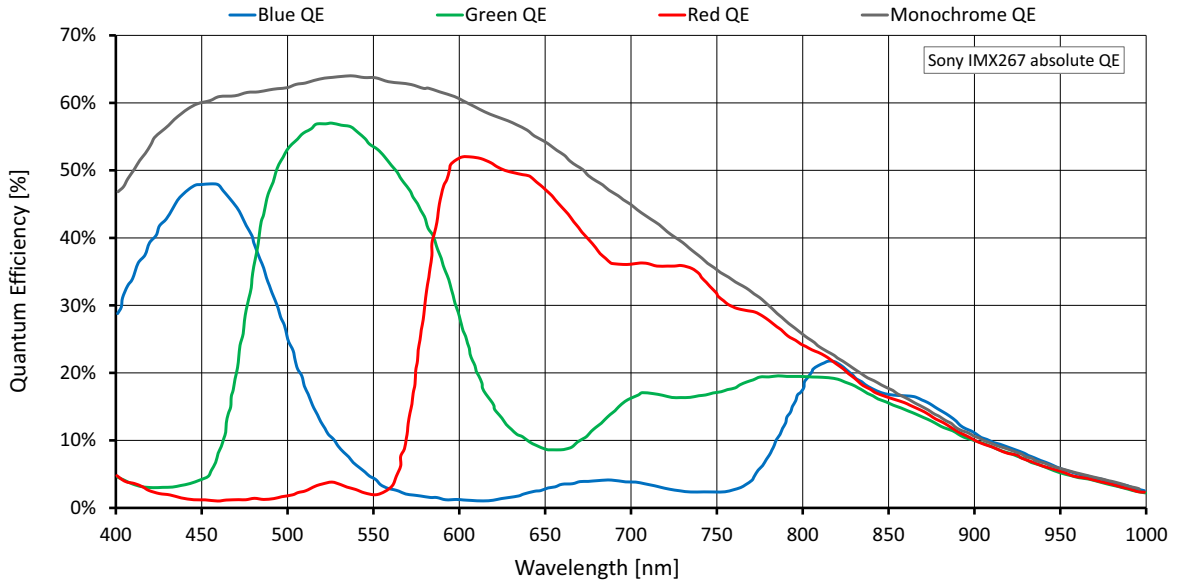

Figure 51: Alvium 1800 U-895m/c (Sony IMX267) absolute QE

Spectral response

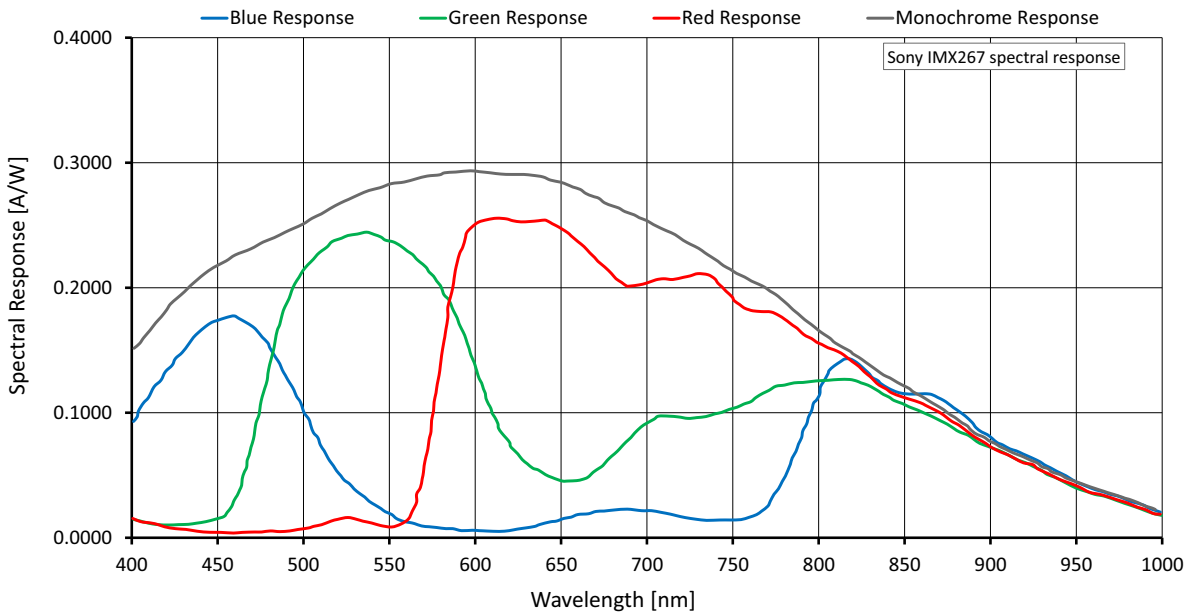

Figure 52: Alvium 1800 U-895m/c (Sony IMX267) spectral response

ROI frame rates

Values are based on the conditions defined in [Specified values](#) on page 77.

To reach the maximum frame rate available for this setup, the bandwidth for image traffic is 375 MByte/s. Increasing the `DeviceLinkThroughputLimit` value does not increase frame rates.

Image format	Width [pixels]	Height [pixels]	ROI area [MP]	Frame rate [fps] ¹		
				450 MByte/s	375 MByte/s	200 MByte/s
Full resolution	4112	2176	8.948	31.5/24.0	31.5/20.3	21.6/10.9
UHD 4K	3840	2160	8.294	31.8/25.9	31.8/21.9	23.3/11.8
QSXGA	2560	2048	5.243	33.6/33.6		33.6/18.6
WQHD	2560	1440	3.686	47.2/47.2		47.2/26.1
QXGA	2048	1536	3.146	44.5/44.5		44.5/30.6
Full HD	1920	1080	2.074	62.3/62.3		62.3/45.8
UXGA	1600	1200	1.92	56.5/56.5		56.5/49.8
WXGA+	1440	900	1.296	74.4/74.4		74.4/72.3
SXGA	1280	1024	1.311	65.9/65.9		
HD 720	1280	720	0.922	91.8/91.8		
XGA	1024	768	0.786	86.6/86.6		
SVGA	800	600	0.48	109.2/109.2		
VGA	640	480	0.307	134.4/134.4		
HVGA	480	320	0.154	193.3/193.3		
QVGA	320	240	0.077	247.8/247.8		
HQVGA	240	160	0.038	345.2/345.2		
QQVGA	160	120	0.019	428.4/428.4		
Max. × half	4112	1088	4.474	60.9/46.6	60.9/39.4	42.0/21.3
Max. × min.	4112	8	0.033	808.2/684.0	808.2/606.6	638.5/379.9
Min. × max.	8	2176	0.017	32.0/32.0		
Min. × min.	8	8	64 Px	1317.0/1317.0		

¹ Mono8 or Bayer...8⁽²⁾ at `SensorBitDepth` = 12-Bit / Mono12 or Bayer...12 at `SensorBitDepth` = 12-Bit

² The three dots... represent the colors of a Bayer pixel format, such as in BayerRG8.

Table 77: Alvium 1800 U-895m/c ROI frame rates

Alvium 1800 U-1236m/c

Feature	Specification	
	1800 U-1236m (monochrome)	1800 U-1236c (color)
Sensor model	Sony IMX304	
Resolution	4112 (H) × 3008 (V); 12.4 MP	
Sensor type	CMOS	
Shutter type	Global shutter (GS)	
Sensor size	Type 1.1; 14.2 mm × 10.4 mm; 17.6 mm diagonal	
Pixel size	3.45 μm × 3.45 μm	
CRA	0 deg	
Sensor bit depth (ADC)	12-bit	
Monochrome pixel formats	Mono8 (default), Mono10, Mono10p, Mono12, Mono12p	Mono8, Mono10, Mono10p, Mono12, Mono12p
YUV color pixel formats	Not applicable	YCbCr411_8_CbYYCrYY, YCbCr422_8_CbYCrY, YCbCr8_CbYCr
RGB color pixel formats	Not applicable	BGR8, RGB8 (default)
Raw color pixel formats	Not applicable	BayerRG8, BayerRG10, BayerRG10p, BayerRG12, BayerRG12p
Maximum frame rate	23 fps (at ≥300 MByte/s)	
Exposure time	29 μs to 10 s (300 MByte/s)	
Exposure modes	Timed, TriggerControlled, TriggerWidth	
Gain	0 dB to 48 dB; 0.1 dB increments	
Digital binning ¹	Horizontal: 1 to 8 columns; Vertical: 1 to 8 rows	
Multiple ROI (H × V)	<i>Free</i>	
Image buffer (RAM)	256 KByte	
Non-volatile memory (Flash)	1024 KByte	
GPIOs	4 programmable GPIOs As direct inputs (push-pull): 0 to 5.5 VDC As direct outputs (push-pull): 0 to 3.3 VDC at 12 mA	
Power requirements	Power over USB; External power	
Power consumption (typical, at 5 VDC)	USB power: 2.9 W External power: 3.1 W	

¹ Digital vertical binning can be used only when digital horizontal binning is used as well.

Table 78: Alvium 1800 U-1236m/c specifications (sheet 1 of 2)

Feature	Specification			
	1800 U-1236m/c			
Storage temperature	-20 °C to +85 °C ambient temperature			
Operating temperature	Hardware option	Housing	Cooling area¹	Mainboard²
	Bare board ³	Not applicable	-20 °C to +85 °C	-20 °C to +88 °C
	Open housing ⁴	-20 °C to +65 °C		
	Closed housing	-20 °C to +65 °C	Not applicable	
Relative humidity	0% to 80% (non-condensing)			
Digital interface	Micro-B USB 3.1 Gen 1 interface			
Camera controls	GenICam (GenICam Access)			
¹ See Mounting the heat sink on page 272. ² Output by <code>DeviceTemperature</code> ³ Ensure that the sensor is operated in the temperature range specified by the manufacturer. For any questions, please visit www.alliedvision.com/en/support . ⁴ Temperature values must be observed for the housing and for the cooling area.				

Table 78: Alvium 1800 U-1236m/c specifications (sheet 2 of 2)

Absolute QE

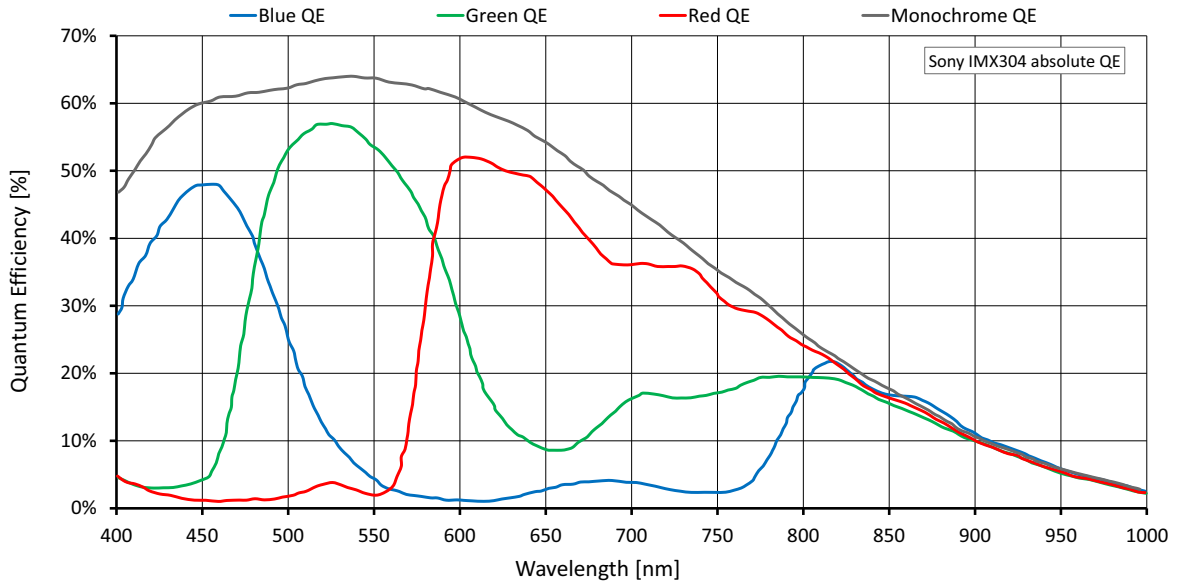

Figure 53: Alvim 1800 U-1236m/c (Sony IMX304) absolute QE

Spectral response

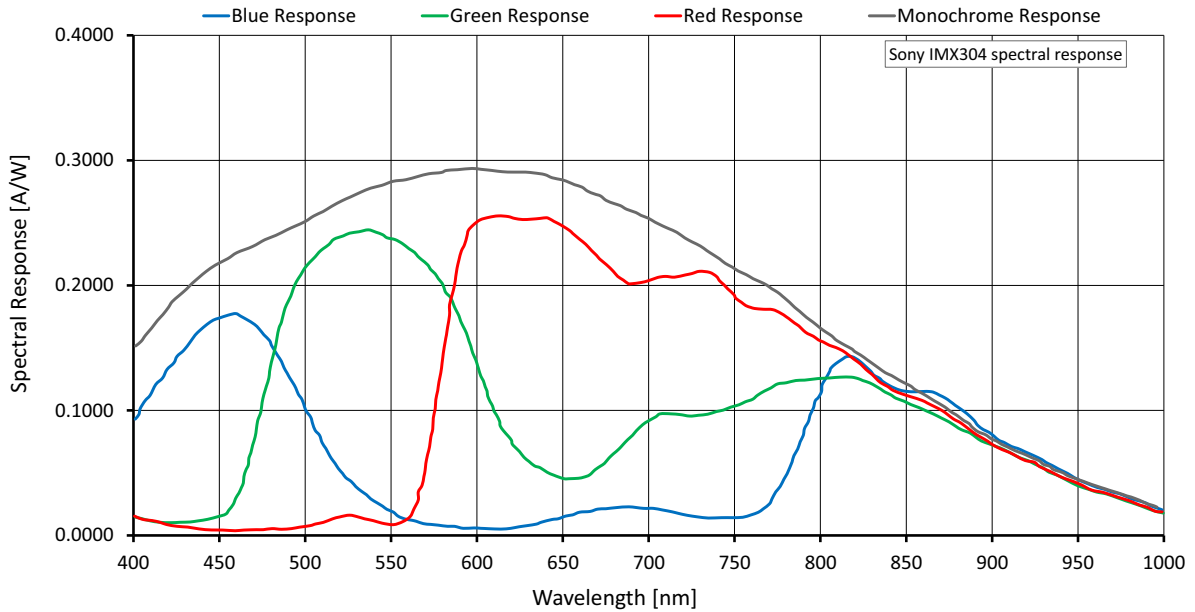

Figure 54: Alvim 1800 U-1236m/c (Sony IMX304) spectral response

ROI frame rates

Values are based on the conditions defined in [Specified values](#) on page 77.

To reach the maximum frame rate available for this setup, the bandwidth for image traffic is 300 MByte/s. Increasing the `DeviceLinkThroughputLimit` value does not increase frame rates.

Image format	Width [pixels]	Height [pixels]	ROI area [MP]	Frame rate [fps] ¹		
				450 MByte/s	375 MByte/s	200 MByte/s
Full resolution	4112	3008	12.369	23.0/17.5	23.0/14.8	15.7/7.9
UHD 4K	3840	2160	8.294	31.7/25.8	31.7/21.8	23.3/11.7
QSXGA	2560	2048	5.243	33.5/33.5		33.5/18.5
WQHD	2560	1440	3.686	47.0/47.0		47.0/26.0
QXGA	2048	1536	3.146	44.3/44.3		44.3/30.5
Full HD	1920	1080	2.074	62.0/62.0		62.0/45.5
UXGA	1600	1200	1.92	56.3/56.3		56.3/49.5
WXGA+	1440	900	1.296	73.9/73.9		73.9/71.9
SXGA	1280	1024	1.311	65.5/65.5		
HD 720	1280	720	0.922	91.1/91.1		
XGA	1024	768	0.786	86.0/86.0		
SVGA	800	600	0.48	108.2/108.2		
VGA	640	480	0.307	132.9/132.9		
HVGA	480	320	0.154	190.2/190.2		
QVGA	320	240	0.077	242.7/242.7		
HQVGA	240	160	0.038	335.5/335.5		
QQVGA	160	120	0.019	413.5/413.5		
Max. × half	4112	1504	6.184	44.7/34.2	44.7/28.8	30.8/15.5
Max. × min.	4112	8	0.033	756.6/635.8	756.6/561.7	591.8/347.3
Min. × max.	8	3008	0.024	23.2/23.2		
Min. × min.	8	8	64 Px	1185.3/1185.3		

¹ Mono8 or Bayer...8⁽²⁾ at `SensorBitDepth` = 12-Bit / Mono12 or Bayer...12 at `SensorBitDepth` = 12-Bit

² The three dots... represent the colors of a Bayer pixel format, such as in BayerRG8.

Table 79: Alvium 1800 U-1236m/c ROI frame rates

Alvium 1800 U-1240m/c

Feature	Specification	
	1800 U-1240m (monochrome)	1800 U-1240c (color)
Sensor model	Sony IMX226	
Resolution	4024 (H) x 3036 (V); 12.2 MP	
Sensor type	CMOS	
Shutter type	Rolling shutter (RS) or Global reset shutter (GRS)	
Sensor size	Type 1/1.7; 7.4 mm x 5.6 mm; 9.3 mm diagonal	
Pixel size	1.85 μm x 1.85 μm	
CRA	0 deg	
Sensor bit depth (ADC)	10-bit	
Monochrome pixel formats	Mono8 (default), Mono10, Mono10p, Mono12, Mono12p	Mono8, Mono10, Mono10p, Mono12, Mono12p
YUV color pixel formats	Not applicable	YCbCr411_8_CbYYCrYY, YCbCr422_8_CbYCrY, YCbCr8_CbYCr
RGB color pixel formats	Not applicable	BGR8, RGB8 (default)
Raw color pixel formats	Not applicable	BayerRG8, BayerRG10, BayerRG10p, BayerRG12, BayerRG12p
Maximum frame rate	35 fps ¹ (at 450 MByte/s)	
Exposure time	11 μs to 10 s (450 MByte/s)	
Exposure modes	Timed	
Gain	0 dB to 27 dB; 0.1 dB increments	
Digital binning ²	Horizontal: 1 to 8 columns; Vertical: 1 to 8 rows	
Image buffer (RAM)	256 KByte	
Non-volatile memory (Flash)	1024 KByte	
GPIOs	4 programmable GPIOs As direct inputs (push-pull): 0 to 5.5 VDC As direct outputs (push-pull): 0 to 3.3 VDC at 12 mA	
Power requirements	Power over USB; External power	
Power consumption (typical, at 5 VDC)	USB power: 3.1 W External power: 3.3 W	
¹ In triggered mode: ~34 fps (monochrome models); ~17 fps (color models)		
² Digital vertical binning can be used only when digital horizontal binning is used as well.		

Table 80: Alvium 1800 U-1240m/c specifications (sheet 1 of 2)

Feature	Specification			
	1800 U-1240m/c			
Storage temperature	-20 °C to +85 °C ambient temperature			
Operating temperature	Hardware option	Housing	Cooling area²	Mainboard³
	Bare board ⁴	Not applicable	-20 °C to +85 °C	-20 °C to +88 °C
	Open housing ⁵	-20 °C to +65 °C		
	Closed housing	-20 °C to +65 °C	Not applicable	
Relative humidity	0% to 80% (non-condensing)			
Digital interface	Micro-B USB 3.1 Gen 1 interface			
Camera controls	GenICam (GenICam Access)			
² See Mounting the heat sink on page 272. ³ Output by <code>DeviceTemperature</code> ⁴ Ensure that the sensor is operated in the temperature range specified by the manufacturer. For any questions, please visit www.alliedvision.com/en/support . ⁵ Temperature values must be observed for the housing and for the cooling area.				

Table 80: Alvium 1800 U-1240m/c specifications (sheet 2 of 2)

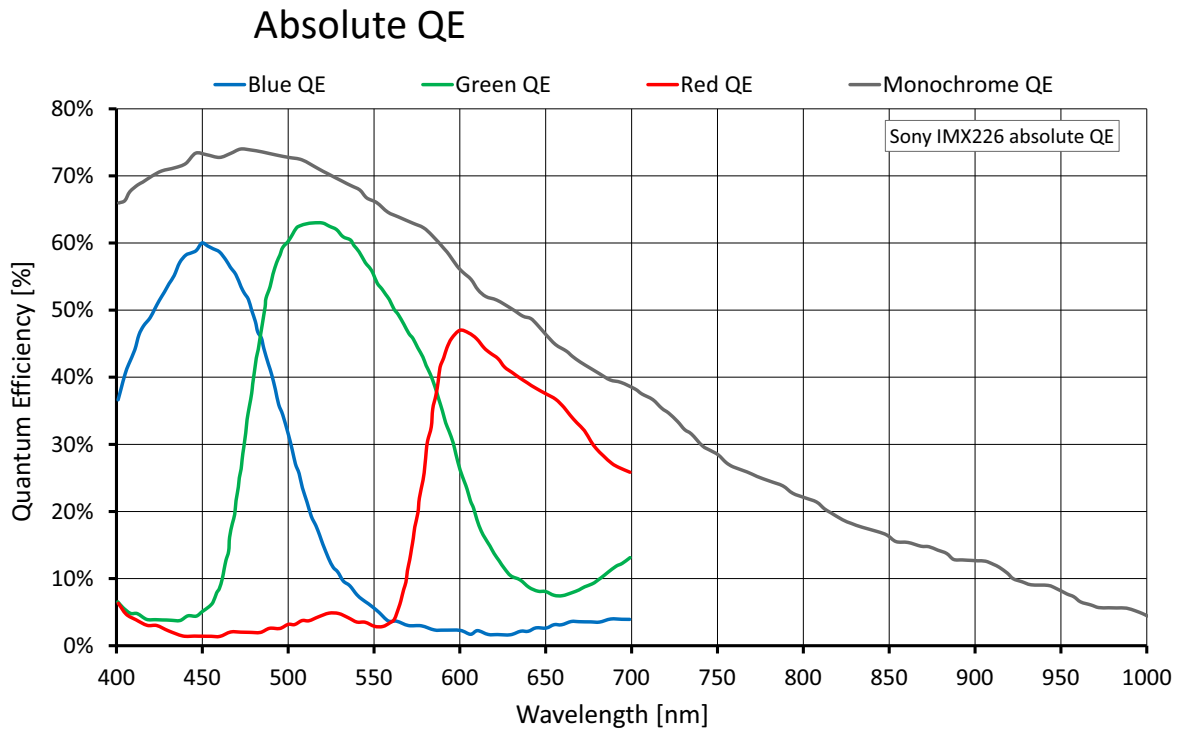

Figure 55: Alvium 1800 U-1240m/c (Sony IMX226) absolute QE

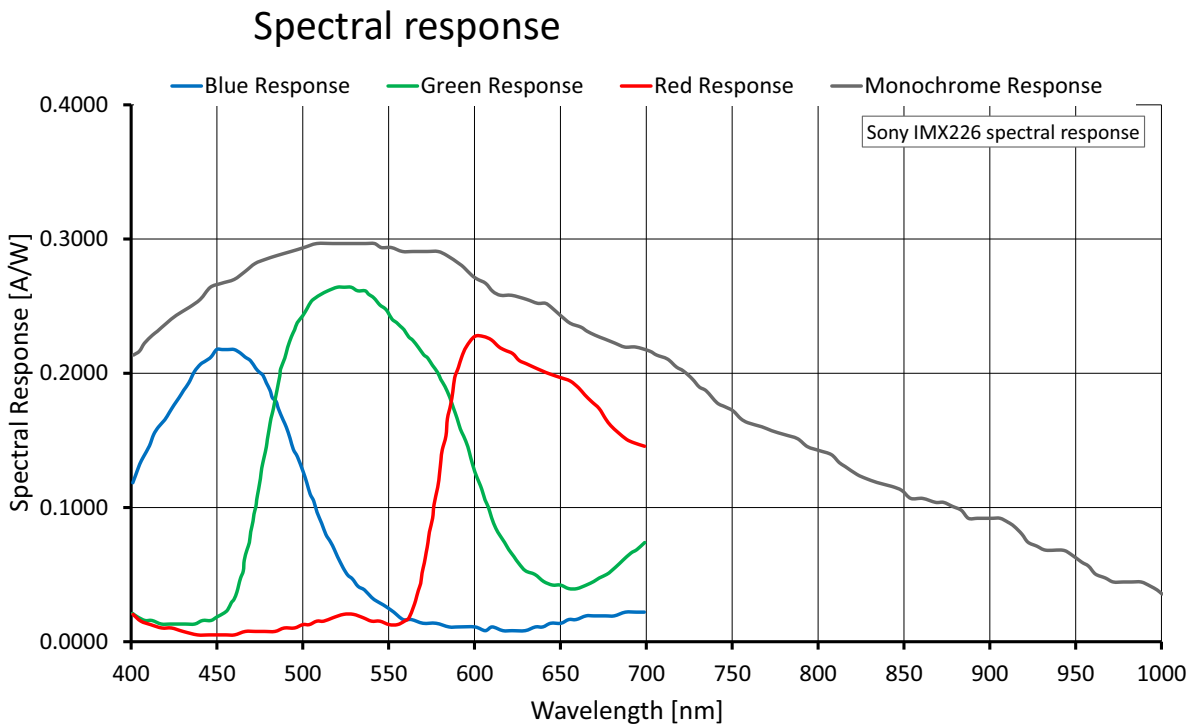

Figure 56: Alvium 1800 U-1240m/c (Sony IMX226) spectral response

ROI frame rates

Values were measured for rolling shutter (RS) mode as defined in [Specified values](#) on page 77. Operation in global reset shutter mode produced identical values.

To reach the maximum frame rate available for this setup, the bandwidth for image traffic is 450 MByte/s.

Shutter mode	User mode	Mono	Color	Available frame rates
Rolling shutter (RS)	Freerun	Values in Table 82 below are reached.		
Rolling shutter (RS)	Triggered	>99%	>50%	... of the values for in Table 82 below are reached.
Global reset shutter (GRS)	Freerun	>99% of the values for in Table 82 below are reached.		
Global reset shutter (GRS)	Triggered	>99%	>50%	... of the values for in Table 82 below are reached.

Table 81: Frame rate behavior for different configurations

Image format	Width [pixels]	Height [pixels]	ROI area [MP]	Frame rate [fps] ¹		
				450 MByte/s	375 MByte/s	200 MByte/s
Full resolution	4024	3036	12.217	35.0/17.7	29.7/15.0	16.0/8.0
UHD 4K	3840	2160	8.294			
QSXGA	2560	2048	5.243			
WQHD	2560	1440	3.686			
QXGA	2048	1536	3.146			
Full HD	1920	1080	2.074			
UXGA	1600	1200	1.920			
WXGA+	1440	900	1.296			
SXGA	1280	1024	1.311			
HD 720	1280	720	0.922			
XGA	1024	768	0.786			
SVGA	800	600	0.480			
VGA	640	480	0.307			
HVGA	480	320	0.154			
QVGA	320	240	0.077			
HQVGA	240	160	0.038			
QQVGA	160	120	0.019			
Max. × half	4024	1518	6.108			
Max. × min.	4024	8	0.032			
Min. × max.	8	3036	0.024			
Min. × min.	8	8	64 Px			

¹ Mono8 or Bayer...8⁽²⁾ at `SensorBitDepth` = 10-Bit / Mono10 or Bayer...10 at `SensorBitDepth` = 10-Bit

² The three dots... represent the colors of a Bayer pixel format, such as in BayerRG8.

Table 82: Alvim 1800 U-1240m/c ROI frame rates

Alvium 1800 U-1242m/c

Feature	Specification	
	1800 U-1242m (monochrome)	1800 U-1242c (color)
Sensor model	Sony IMX545	
Resolution	4128 (H) × 3008 (V); 12.4 MP	
Sensor type	CMOS	
Shutter type	Global shutter (GS)	
Sensor size	Type 1/1.1; 11.3 mm × 8.2 mm; 14.0 mm diagonal	
Pixel size	2.74 μm × 2.74 μm	
CRA	0 deg	
Sensor bit depth (ADC)	12-bit	
Monochrome pixel formats	Mono8 (default), Mono10, Mono10p, Mono12, Mono12p	Mono8, Mono10, Mono10p, Mono12, Mono12p
YUV color pixel formats	Not applicable	YCbCr411_8_CbYYCrYY, YCbCr422_8_CbYCrY, YCbCr8_CbYCr
RGB color pixel formats	Not applicable	BGR8, RGB8 (default)
Raw color pixel formats	Not applicable	BayerRG8, BayerRG10, BayerRG10p, BayerRG12, BayerRG12p
Maximum frame rate	33 fps (at 450 MByte/s)	
Exposure time	12 μs to 10 s (450 MByte/s)	
Exposure modes	Timed, TriggerControlled, TriggerWidth	
Gain	0 dB to 48 dB; 0.1 dB increments	
Digital binning ¹	Horizontal: 1 to 8 columns; Vertical: 1 to 8 rows	
Sensor binning (H × V)	2 × 2 (<i>Sum</i>)	Not applicable
Multiple ROI (H × V)	<i>Free Tile Horizontal</i> : 1 × 1 to 1 × 4 <i>Vertical</i> : 1 × 1 to 1 × 4	
Image buffer (RAM)	256 KByte	
Non-volatile memory (Flash)	1024 KByte	
GPIOs	4 programmable GPIOs As direct inputs (push-pull): 0 to 5.5 VDC As direct outputs (push-pull): 0 to 3.3 VDC at 12 mA	
Power requirements	Power over USB; External power	
Power consumption (typical, at 5 VDC)	USB power: 3.4 W External power: 3.6 W	

¹ Digital vertical binning can be used only when digital horizontal binning is used as well.

Table 83: Alvium 1800 U-1242m/c specifications (sheet 1 of 2)

Feature	Specification			
	1800 U-1242m/c			
Storage temperature	-20 °C to +85 °C ambient temperature			
Operating temperature	Hardware option	Housing	Cooling area¹	Mainboard²
	Bare board ³	Not applicable	-20 °C to +85 °C	-20 °C to +85 °C
	Open housing ⁴	-20 °C to +65 °C		
	Closed housing	-20 °C to +65 °C	Not applicable	
Relative humidity	0% to 80% (non-condensing)			
Digital interface	Micro-B USB 3.1 Gen 1 interface			
Camera controls	GenICam (GenICam Access)			
¹ See Mounting the heat sink on page 272. ² Output by <code>DeviceTemperature</code> ³ Ensure that the sensor is operated in the temperature range specified by the manufacturer. For any questions, please visit www.alliedvision.com/en/support . ⁴ Temperature values must be observed for the housing and for the cooling area.				

Table 83: Alvium 1800 U-1242m/c specifications (sheet 2 of 2)

Absolute QE

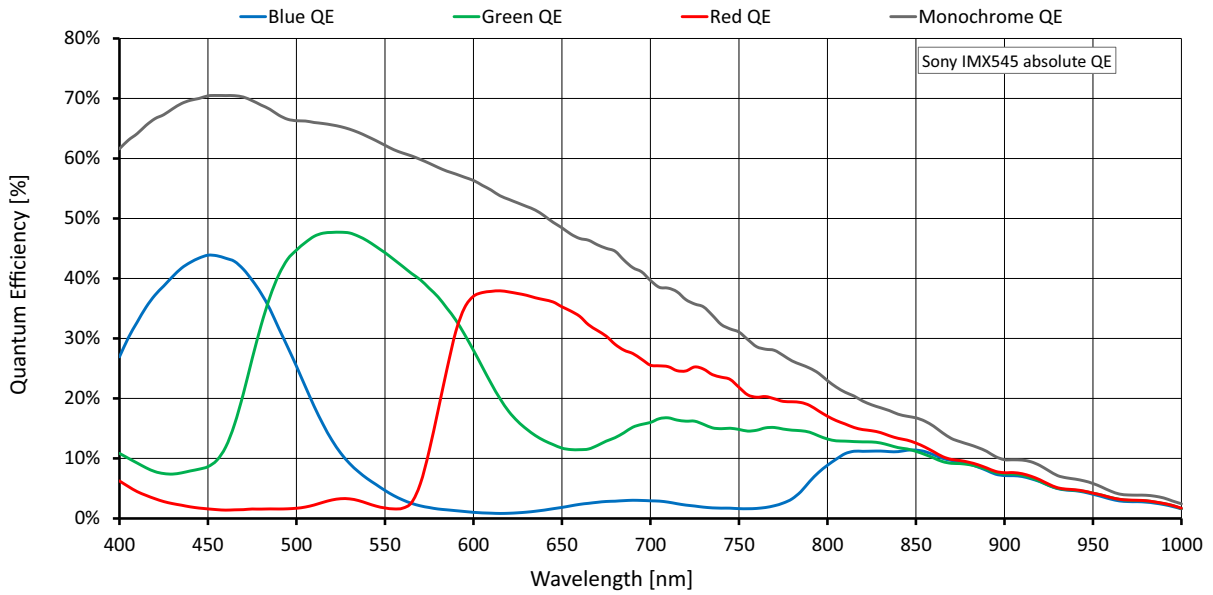

Figure 57: Alivum 1800 U-1242m/c (Sony IMX545) absolute QE

Spectral response

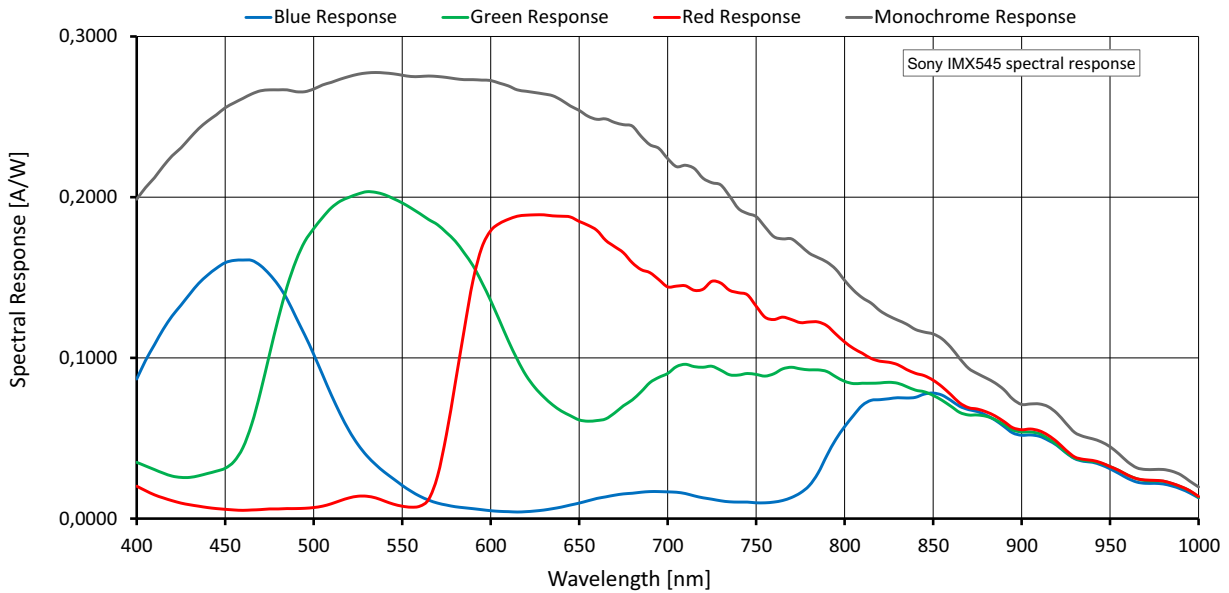

Figure 58: Alivum 1800 U-1242m/c (Sony IMX545) spectral response

ROI frame rates

Values are based on the conditions defined in [Specified values](#) on page 77.

To reach the maximum frame rate available for this setup, the bandwidth for image traffic is 450 MByte/s.

Image format	Width [pixels]	Height [pixels]	ROI area [MP]	Frame rate [fps] ¹		
				450 MByte/s	375 MByte/s	200 MByte/s
Full resolution	4128	3008	12.417	33.9/17.1	28.5/14.4	15.3/7.7
UHD 4K	3840	2160	8.294	49.7/25.0	41.7/21.1	22.5/11.3
QSXGA	2560	2048	5.243	59.0/39.4	59.0/33.2	35.4/17.8
WQHD	2560	1440	3.686	81.4/54.3	81.4/45.9	48.9/24.6
QXGA	2048	1536	3.146	77.1/64.2	77.1/54.1	57.5/29.0
Full HD	1920	1080	2.074	105.5/93.9	105.5/79.2	84.0/42.4
UXGA	1600	1200	1.92	96.5/96.5	96.5/86.3	92.0/46.4
WXGA+	1440	900	1.296	123.7/123.7	123.7/122.8	123.7/66.0
SXGA	1280	1024	1.311	111.2/111.2		111.2/66.7
HD 720	1280	720	0.922	149.9/149.9		149.9/90.1
XGA	1024	768	0.786	142.6/142.6		142.6/106.9
SVGA	800	600	0.48	175.0/175.0		175.0/167.0
VGA	640	480	0.307	209.2/209.2		
HVGA	480	320	0.154	281.7/281.7		
QVGA	320	240	0.077	340.4/340.4		
HQVGA	240	160	0.038	430.0/430.0		
QQVGA	160	120	0.019	495.2/495.2		
Max. × half	4128	1504	6.209	64.3/32.5	54.1/27.4	29.2/14.7
Max. × min.	4128	8	0.033	589.7/329.0	511.6/281.9	299.2/157.4
Min. × max.	8	3008	0.024	41.5/41.5		
Min. × min.	8	8	64 Px	860.0/860.0		

¹ Mono8 or Bayer...8⁽²⁾ at SensorBitDepth = 12-Bit / Mono12 or Bayer...12 at SensorBitDepth = 12-Bit

² The three dots... represent the colors of a Bayer pixel format, such as in BayerRG8.

Table 84: Alvium 1800 U-1242m/c ROI frame rates

Alvium 1800 U-1620m/c

Feature	Specification	
	1800 U-1620m (monochrome)	1800 U-1620c (color)
Sensor model	Sony IMX542	
Resolution	5328 (H) × 3040 (V); 16.2 MP	
Sensor type	CMOS	
Shutter type	Global shutter (GS)	
Sensor size	Type 1.1; 14.6 mm × 8.3 mm; 16.8 mm diagonal	
Pixel size	2.74 μm × 2.74 μm	
CRA	0 deg	
Sensor bit depth (ADC)	12-bit	
Monochrome pixel formats	Mono8 (default), Mono10, Mono10p, Mono12, Mono12p	Mono8, Mono10, Mono10p, Mono12, Mono12p
YUV color pixel formats	Not applicable	YCbCr411_8_CbYYCrYY, YCbCr422_8_CbYCrY, YCbCr8_CbYCr
RGB color pixel formats	Not applicable	BGR8, RGB8 (default)
Raw color pixel formats	Not applicable	BayerRG8, BayerRG10, BayerRG10p, BayerRG12, BayerRG12p
Maximum frame rate	26 fps (at 450 MByte/s)	
Exposure time	15 μs to 10 s (450 MByte/s)	
Exposure modes	Timed, TriggerControlled, TriggerWidth	
Gain	0 dB to 48 dB; 0.1 dB increments	
Digital binning ¹	Horizontal: 1 to 8 columns; Vertical: 1 to 8 rows	
Sensor binning (H × V)	2 × 2 (<i>Sum</i>)	Not applicable
Multiple ROI (H × V)	<i>Free Tile Horizontal</i> : 1 × 1 to 1 × 4 <i>Vertical</i> : 1 × 1 to 1 × 4	
Image buffer (RAM)	256 KByte	
Non-volatile memory (Flash)	1024 KByte	
GPIOs	4 programmable GPIOs As direct inputs (push-pull): 0 to 5.5 VDC As direct outputs (push-pull): 0 to 3.3 VDC at 12 mA	
Power requirements	Power over USB; External power	
Power consumption (typical, at 5 VDC)	USB power: 4.0 W External power: 4.2 W	

¹ Digital vertical binning can be used only when digital horizontal binning is used as well.

Table 85: Alvium 1800 U-1620m/c specifications (sheet 1 of 2)

Feature	Specification			
	1800 U-1620m/c			
Storage temperature	-20 °C to +85 °C ambient temperature			
Operating temperature	Hardware option	Housing	Cooling area¹	Mainboard²
	Bare board ³	Not applicable	-20 °C to +85 °C	-20 °C to +85 °C
	Open housing ⁴	-20 °C to +65 °C		
	Closed housing	-20 °C to +65 °C	Not applicable	
Relative humidity	0% to 80% (non-condensing)			
Digital interface	Micro-B USB 3.1 Gen 1 interface			
Camera controls	GenICam (GenICam Access)			
¹ See Mounting the heat sink on page 272. ² Output by <code>DeviceTemperature</code> ³ Ensure that the sensor is operated in the temperature range specified by the manufacturer. For any questions, please visit www.alliedvision.com/en/support . ⁴ Temperature values must be observed for the housing and for the cooling area.				

Table 85: Alvium 1800 U-1620m/c specifications (sheet 2 of 2)

Absolute QE

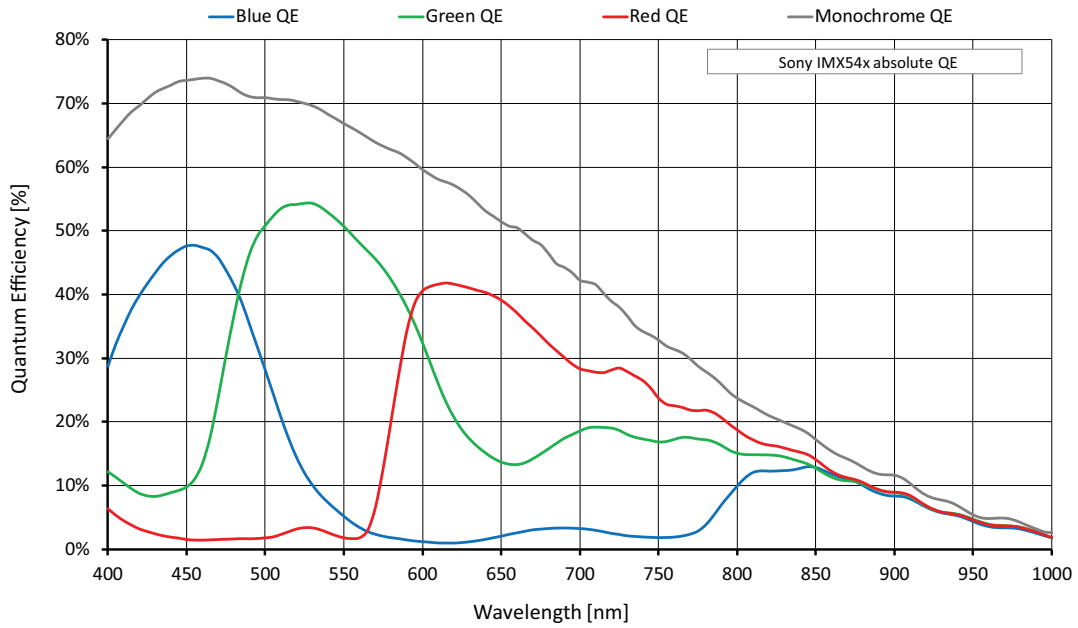

Figure 59: Alvium 1800 U-1620m/c (Sony IMX542) absolute QE

Spectral response

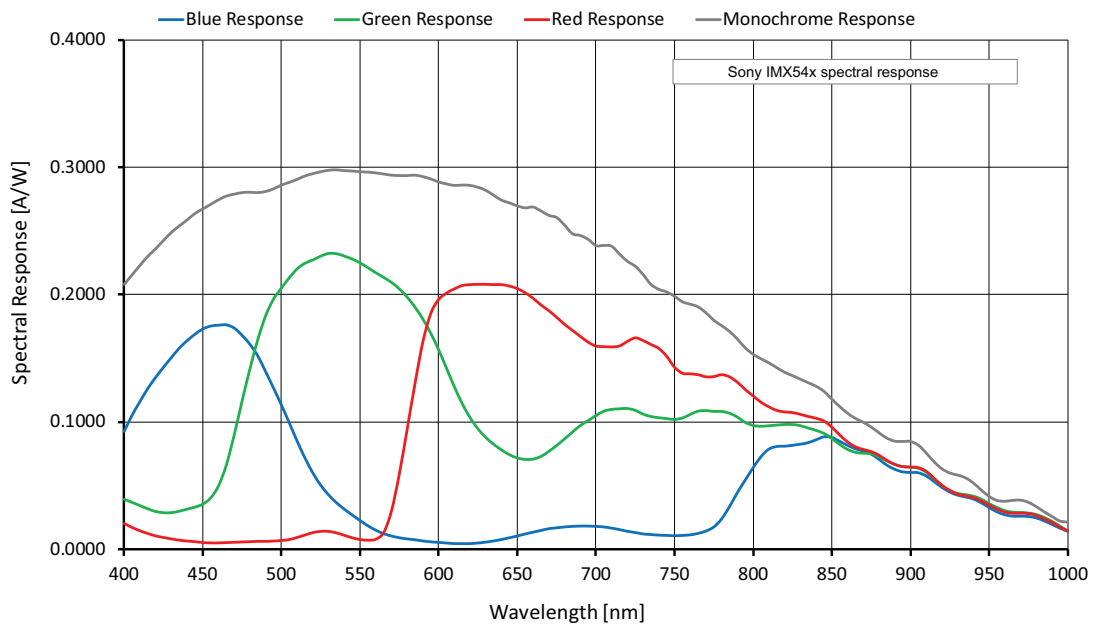

Figure 60: Alvium 1800 U-1620m/c (Sony IMX542) spectral response

ROI frame rates

Values are based on the conditions defined in [Specified values](#) on page 77.

To reach the maximum frame rate available for this setup, the bandwidth for image traffic is 450 MByte/s.

Image format	Width [pixels]	Height [pixels]	ROI area [MP]	Frame rate [fps] ¹		
				450 MByte/s	375 MByte/s	200 MByte/s
Full resolution	5328	3040	16.197	26.2/13.2	22.0/11.1	11.8/5.9
UHD 4K	3840	2160	8.294	44.6/25.3	42.1/21.3	22.7/11.4
QSXGA	2560	2048	5.243	47.1/39.7	47.1/33.5	35.7/18.0
WQHD	2560	1440	3.686	65.3/55.0	65.3/46.5	49.6/25.0
QXGA	2048	1536	3.146	61.7/61.7	61.7/54.8	58.2/29.4
Full HD	1920	1080	2.074	84.9/84.9	84.9/80.5	84.9/43.1
UXGA	1600	1200	1.92	77.5/77.5		77.5/47.1
WXGA+	1440	900	1.296	99.7/99.7		99.7/67.2
SXGA	1280	1024	1.311	89.4/89.4		89.4/67.8
HD 720	1280	720	0.922	121.5/121.5		121.5/92.2
XGA	1024	768	0.786	115.2/115.2		115.2/109.3
SVGA	800	600	0.48	142.2/142.2		
VGA	640	480	0.307	171.0/171.0		
HVGA	480	320	0.154	232.8/232.8		
QVGA	320	240	0.077	284.1/284.1		
HQVGA	240	160	0.038	364.4/364.4		
QQVGA	160	120	0.019	424.4/424.4		
Max. × half	5328	1520	8.099	49.9/25.2	42.1/21.3	22.7/11.4
Max. × min.	5328	8	0.043	513.0/290.3	447.8/249.3	264.1/140.1
Min. × max.	8	3040	0.024	32.6/32.6		
Min. × min.	8	8	64 Px	787.2/787.2		

¹ Mono8 or Bayer...8⁽²⁾ at SensorBitDepth = 12-Bit / Mono12 or Bayer...12 at SensorBitDepth = 12-Bit

² The three dots... represent the colors of a Bayer pixel format, such as in BayerRG8.

Table 86: Alvium 1800 U-1620m/c ROI frame rates

Alvium 1800 U-2040m/c

Feature	Specification	
	1800 U-2040m (monochrome)	1800 U-2040c (color)
Sensor model	Sony IMX541	
Resolution	4512 (H) × 4512 (V); 20.4 MP	
Sensor type	CMOS	
Shutter type	Global shutter (GS)	
Sensor size	Type 1.1; 12.4 mm × 12.4 mm; 17.5 mm diagonal	
Pixel size	2.74 μm × 2.74 μm	
CRA	0 deg	
Sensor bit depth (ADC)	12-bit	
Monochrome pixel formats	Mono8 (default), Mono10, Mono10p, Mono12, Mono12p	Mono8, Mono10, Mono10p, Mono12, Mono12p
YUV color pixel formats	Not applicable	YCbCr411_8_CbYYCrYY, YCbCr422_8_CbYCrY, YCbCr8_CbYCr
RGB color pixel formats	Not applicable	BGR8, RGB8 (default)
Raw color pixel formats	Not applicable	BayerRG8, BayerRG10, BayerRG10p, BayerRG12, BayerRG12p
Maximum frame rate	21 fps (at 450 MByte/s)	
Exposure time	13 μs to 10 s (450 MByte/s)	
Exposure modes	Timed, TriggerControlled, TriggerWidth	
Gain	0 dB to 48 dB; 0.1 dB increments	
Digital binning ¹	Horizontal: 1 to 8 columns; Vertical: 1 to 8 rows	
Sensor binning (H × V)	2 × 2 (<i>Sum</i>)	Not applicable
Multiple ROI (H × V)	<i>Free Tile Horizontal</i> : 1 × 1 to 1 × 4 <i>Vertical</i> : 1 × 1 to 1 × 4	
Image buffer (RAM)	256 KByte	
Non-volatile memory (Flash)	1024 KByte	
GPIOs	4 programmable GPIOs As direct inputs (push-pull): 0 to 5.5 VDC As direct outputs (push-pull): 0 to 3.3 VDC at 12 mA	
Power requirements	Power over USB; External power	
Power consumption (typical, at 5 VDC)	USB power: 3.9 W External power: 4.1 W	

¹ Digital vertical binning can be used only when digital horizontal binning is used as well.

Table 87: Alvium 1800 U-2040m/c specifications (sheet 1 of 2)

Feature	Specification			
	1800 U-2040m/c			
Storage temperature	-20 °C to +85 °C ambient temperature			
Operating temperature	Hardware option	Housing	Cooling area¹	Mainboard²
	Bare board ³	Not applicable	-20 °C to +85 °C	-20 °C to +85 °C
	Open housing ⁴	-20 °C to +65 °C		
	Closed housing	-20 °C to +65 °C	Not applicable	
Relative humidity	0% to 80% (non-condensing)			
Digital interface	Micro-B USB 3.1 Gen 1 interface			
Camera controls	GenICam (GenICam Access)			
¹ See Mounting the heat sink on page 272. ² Output by <code>DeviceTemperature</code> ³ Ensure that the sensor is operated in the temperature range specified by the manufacturer. For any questions, please visit www.alliedvision.com/en/support . ⁴ Temperature values must be observed for the housing and for the cooling area.				

Table 87: Alvium 1800 U-2040m/c specifications (sheet 2 of 2)

Absolute QE

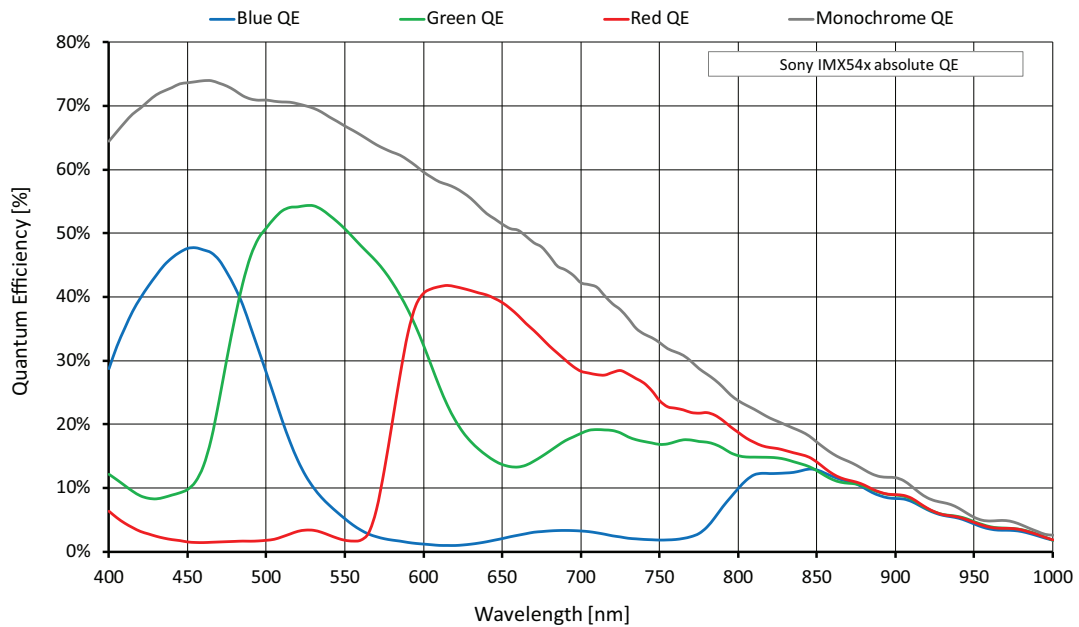

Figure 61: Alvium 1800 U-2040m/c (Sony IMX541) absolute QE

Spectral response

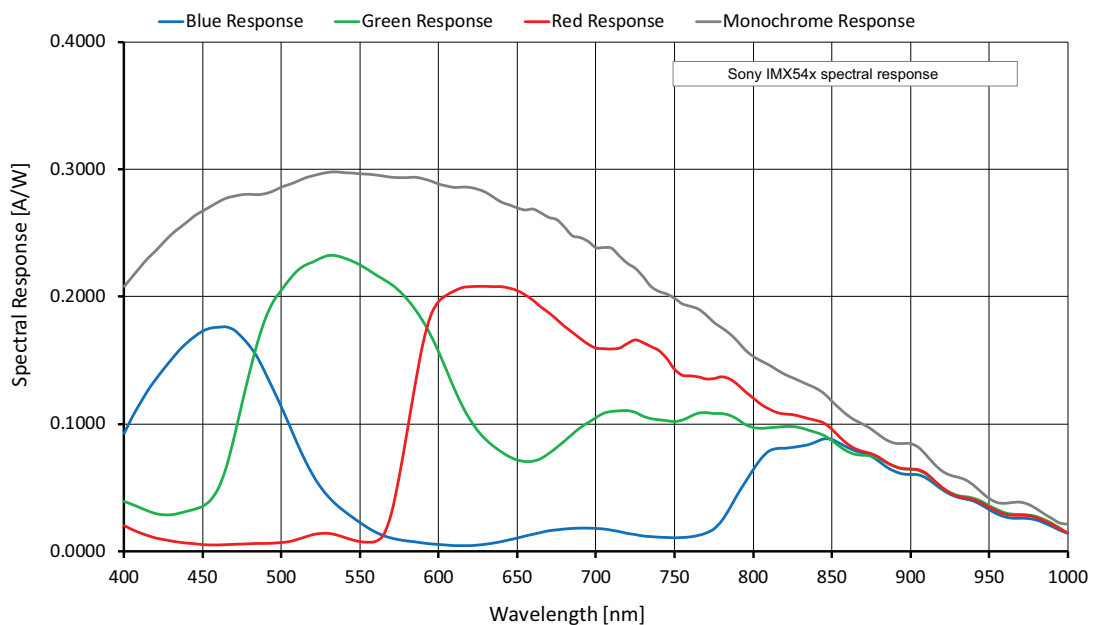

Figure 62: Alvium 1800 U-2040m/c (Sony IMX541) spectral response

ROI frame rates

Values are based on the conditions defined in [Specified values](#) on page 77.

To reach the maximum frame rate available for this setup, the bandwidth for image traffic is 450 MByte/s.

Image format	Width [pixels]	Height [pixels]	ROI area [MP]	Frame rate [fps] ¹		
				450 MByte/s	375 MByte/s	200 MByte/s
Full resolution	4512	4512	20.358	21.1/10.6	17.8/8.9	9.5/4.8
HXGA	4096	3072	12.583	33.6/16.9	28.4/14.3	15.2/7.6
UHD 4K	3840	2160	8.294	50.1/25.2	42.1/21.3	22.6/11.4
QSXGA	2560	2048	5.243	55.0/39.7	55.0/33.5	35.7/18.0
WQHD	2560	1440	3.686	76.0/55.0	76.0/46.4	49.5/24.9
QXGA	2048	1536	3.146	71.9/64.8	71.9/54.7	58.1/29.4
Full HD	1920	1080	2.074	98.9/95.3	98.9/80.4	85.3/43.0
UXGA	1600	1200	1.92	90.2/90.2	90.2/87.4	90.2/47.1
WXGA+	1440	900	1.296	116.1/116.1		116.1/67.1
SXGA	1280	1024	1.311	104.2/104.2		104.2/67.7
HD 720	1280	720	0.922	141.3/141.3		141.3/92.0
XGA	1024	768	0.786	134.2/134.2		134.2/109.0
SVGA	800	600	0.48	165.6/165.6		
VGA	640	480	0.307	198.9/198.9		
HVGA	480	320	0.154	270.3/270.3		
QVGA	320	240	0.077	329.3/329.3		
HQVGA	240	160	0.038	421.5/421.5		
QQVGA	160	120	0.019	490.0/490.0		
Max. × half	4512	2256	10.179	40.9/20.6	34.4/17.4	18.5/9.3
Max. × min.	4512	8	0.036	598.4/338.1	521.2/290.4	307.7/163.1
Min. × max.	8	4512	0.036	26.0/26.0		
Min. × min.	8	8	64 Px	899.5/899.5		

¹ Mono8 or Bayer...8⁽²⁾ at **SensorBitDepth** = 12-Bit /
Mono12 or Bayer...12 at **SensorBitDepth** = 12-Bit

² The three dots... represent the colors of a Bayer pixel format, such as in Bayer**RG8**.

Table 88: Alvium 1800 U-2040m/c ROI frame rates

Alvium 1800 U-2050m/c

Feature	Specification	
	1800 U-2050m (monochrome)	1800 U-2050c (color)
Sensor model	Sony IMX183	
Resolution	5496 (H) × 3672 (V); 20.2 MP	
Sensor type	CMOS	
Shutter type	Rolling shutter (RS) or Global reset shutter (GRS)	
Sensor size	Type 1; 13.1 mm × 8.8 mm; 15.9 mm diagonal	
Pixel size	2.4 μm × 2.4 μm	
CRA	3 deg	
Sensor bit depth (ADC)	10-bit	
Monochrome pixel formats	Mono8 (default), Mono10, Mono10p, Mono12, Mono12p	Mono8, Mono10, Mono10p, Mono12, Mono12p
YUV color pixel formats	Not applicable	YCbCr411_8_CbYYCrYY, YCbCr422_8_CbYCrY, YCbCr8_CbYCr
RGB color pixel formats	Not applicable	BGR8, RGB8 (default)
Raw color pixel formats	Not applicable	BayerRG8, BayerRG10, BayerRG10p, BayerRG12, BayerRG12p
Maximum frame rate	21 fps ¹ (at 450 MByte/s)	
Exposure time	15 μs to 10 s (450 MByte/s)	
Exposure modes	Timed	
Gain	0 dB to 27 dB; 0.1 dB increments	
Digital binning ²	Horizontal: 1 to 8 columns; Vertical: 1 to 8 rows	
Image buffer (RAM)	256 KByte	
Non-volatile memory (Flash)	1024 KByte	
GPIOs	4 programmable GPIOs As direct inputs (push-pull): 0 to 5.5 VDC As direct outputs (push-pull): 0 to 3.3 VDC at 12 mA	
Power requirements	Power over USB; External power	
Power consumption (typical, at 5 VDC)	USB power: 3.2 W External power: 3.4 W	
¹ In triggered mode: ~21 fps (monochrome models); ~10 fps (color models)		
² Digital vertical binning can be used only when digital horizontal binning is used as well.		

Table 89: Alvium 1800 U-2050m/c specifications (sheet 1 of 2)

Feature	Specification			
	1800 U-2050m/c			
Storage temperature	-20 °C to +85 °C ambient temperature			
Operating temperature	Hardware option	Housing	Cooling area²	Mainboard³
	Bare board ⁴	Not applicable	-20 °C to +85 °C	-20 °C to +88 °C
	Open housing ⁵	-20 °C to +65 °C		
	Closed housing	-20 °C to +65 °C	Not applicable	
Relative humidity	0% to 80% (non-condensing)			
Digital interface	Micro-B USB 3.1 Gen 1 interface			
Camera controls	GenICam (GenICam Access)			
² See Mounting the heat sink on page 272. ³ Output by <code>DeviceTemperature</code> ⁴ Ensure that the sensor is operated in the temperature range specified by the manufacturer. For any questions, please visit www.alliedvision.com/en/support . ⁵ Temperature values must be observed for the housing and for the cooling area.				

Table 89: Alvium 1800 U-2050m/c specifications (sheet 2 of 2)

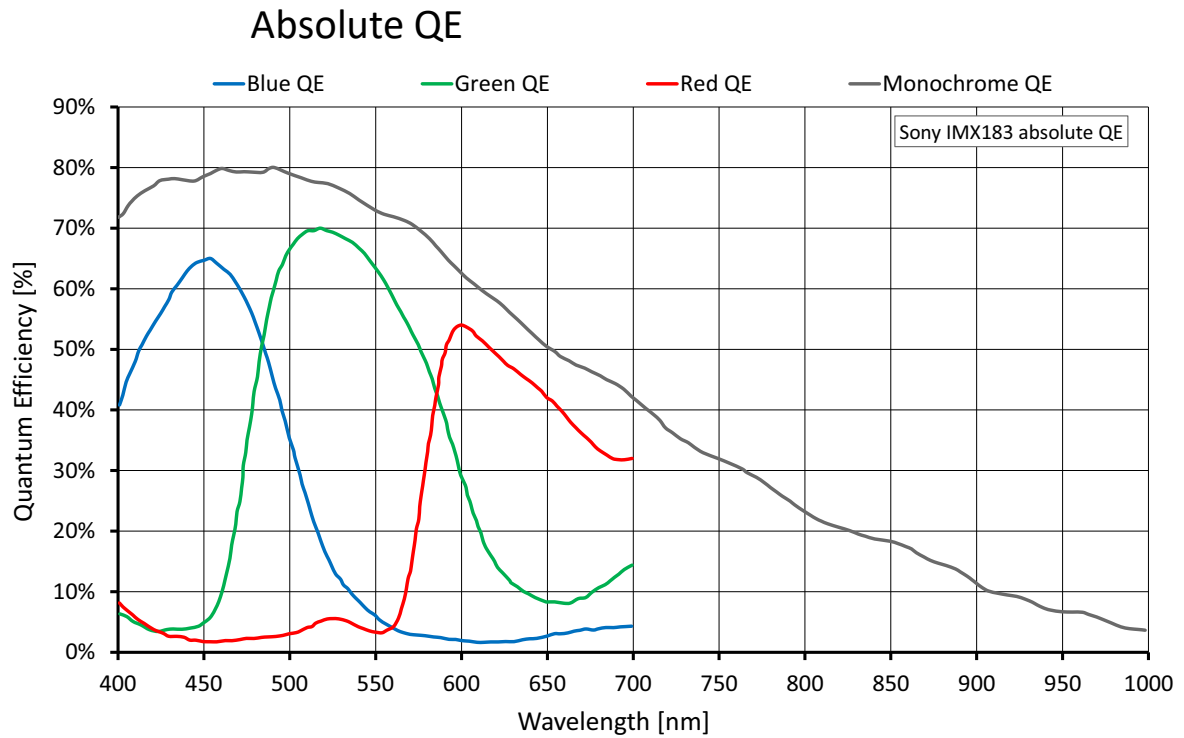

Figure 63: Alvium 1800 U-2050m/c (Sony IMX183) absolute QE

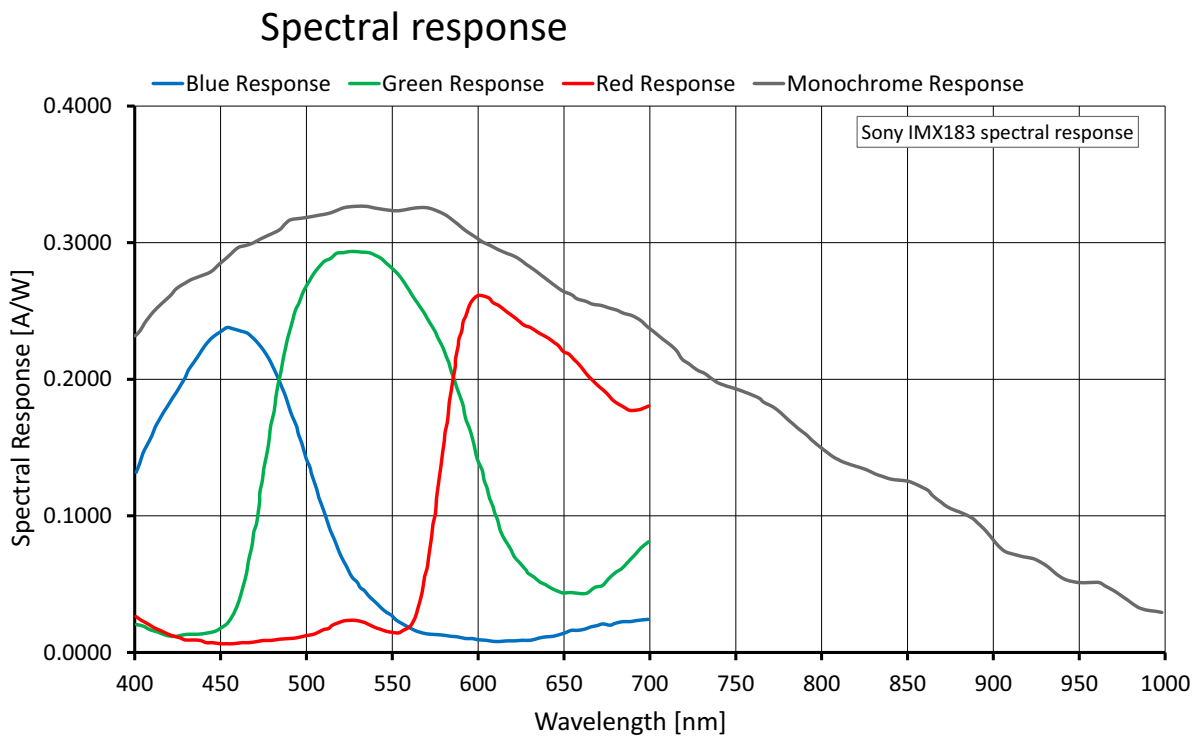

Figure 64: Alvium 1800 U-2050m/c (Sony IMX183) spectral response

ROI frame rates

Values were measured for rolling shutter (RS) mode as defined in [Specified values](#) on page 77.

To reach the maximum frame rate available for this setup, the bandwidth for image traffic is 450 MByte/s.

Shutter mode	User mode	Mono	Color	Available frame rates
Rolling shutter (RS)	Freerun	Values in Table 91 below are reached.		
Rolling shutter (RS)	Triggered	>99%	>50%	... of the values for in Table 91 below are reached.
Global reset shutter (GRS)	Freerun	>99% of the values for in Table 91 below are reached.		
Global reset shutter (GRS)	Triggered	>99%	>50%	... of the values for in Table 91 below are reached.

Table 90: Frame rate behavior for different configurations

Image format	Width [pixels]	Height [pixels]	ROI area [MP]	Frame rate [fps] ¹		
				450 MByte/s	375 MByte/s	200 MByte/s
Full resolution	5496	3672	20.181	21.4/10.7	18.1/9.1	9.7/4.9
HXGA	4096	3072	12.583	25.4/12.8	21.5/10.8	11.5/5.8
UHD 4K	3840	2160	8.294	35.6/18.0	30.1/15.2	16.2/8.1
QSXGA	2560	2048	5.243	37.4/18.9	31.7/16.0	17.0/8.6
WQHD	2560	1440	3.686	41.2/20.9	34.9/17.6	18.8/9.5
QXGA	2048	1536	3.146			
Full HD	1920	1080	2.074			
UXGA	1600	1200	1.92			
WXGA+	1440	900	1.296			
SXGA	1280	1024	1.311			
HD 720	1280	720	0.922			
XGA	1024	768	0.786			
SVGA	800	600	0.48			
VGA	640	480	0.307			
HVGA	480	320	0.154			
QVGA	320	240	0.077			
HQVGA	240	160	0.038			
QQVGA	160	120	0.019			
Max. x half	5496	1836	10.091			
Max. x min.	5496	8	0.044			
Min. x max.	8	3672	0.029	21.4/10.7	18.1/9.1	9.7/4.9
Min. x min.	8	8	64 Px	41.2/20.9	34.9/17.6	17.7/9.5

¹ Mono8 or Bayer...8⁽²⁾ at **SensorBitDepth** = 10-Bit / Mono10 or Bayer...10 at **SensorBitDepth** = 10-Bit

² The three dots... represent the colors of a Bayer pixel format, such as in Bayer**RG8**.

Table 91: Alvium 1800 U-2050m/c ROI frame rates

Alvium 1800 U-2460m/c

Feature	Specification	
	1800 U-2460m (monochrome)	1800 U-2460c (color)
Sensor model	Sony IMX540	
Resolution	5328 (H) × 4608 (V); 24.6 MP	
Sensor type	CMOS	
Shutter type	Global shutter (GS)	
Sensor size	Type 1.2; 14.6 mm × 12.6 mm; 19.3 mm diagonal	
Pixel size	2.74 μm × 2.74 μm	
CRA	0 deg	
Sensor bit depth (ADC)	12-bit	
Monochrome pixel formats	Mono8 (default), Mono10, Mono10p, Mono12, Mono12p	Mono8, Mono10, Mono10p, Mono12, Mono12p
YUV color pixel formats	Not applicable	YCbCr411_8_CbYYCrYY, YCbCr422_8_CbYCrY, YCbCr8_CbYCr
RGB color pixel formats	Not applicable	BGR8, RGB8 (default)
Raw color pixel formats	Not applicable	BayerRG8, BayerRG10, BayerRG10p, BayerRG12, BayerRG12p
Maximum frame rate	17 fps (at 450 MByte/s)	
Exposure time	15 μs to 10 s (450 MByte/s)	
Exposure modes	Timed, TriggerControlled, TriggerWidth	
Gain	0 dB to 48 dB; 0.1 dB increments	
Digital binning ¹	Horizontal: 1 to 8 columns; Vertical: 1 to 8 rows	
Sensor binning (H × V)	2 × 2 (<i>Sum</i>)	Not applicable
Multiple ROI (H × V)	<i>Free Tile Horizontal</i> : 1 × 1 to 1 × 4 <i>Vertical</i> : 1 × 1 to 1 × 4	
Image buffer (RAM)	256 KByte	
Non-volatile memory (Flash)	1024 KByte	
GPIOs	4 programmable GPIOs As direct inputs (push-pull): 0 to 5.5 VDC As direct outputs (push-pull): 0 to 3.3 VDC at 12 mA	
Power requirements	Power over USB; External power	
Power consumption (typical, at 5 VDC)	USB power: 4.0 W External power: 4.2 W	

¹ Digital vertical binning can be used only when digital horizontal binning is used as well.

Table 92: Alvium 1800 U-2460m/c specifications (sheet 1 of 2)

Feature	Specification			
	1800 U-2460m/c			
Storage temperature	-20 °C to +85 °C ambient temperature			
Operating temperature	Hardware option	Housing	Cooling area²	Mainboard³
	Bare board ⁴	Not applicable	-20 °C to +85 °C	-20 °C to +85 °C
	Open housing ⁵	-20 °C to +65 °C		
	Closed housing	-20 °C to +65 °C	Not applicable	
Relative humidity	0% to 80% (non-condensing)			
Digital interface	Micro-B USB 3.1 Gen 1 interface			
Camera controls	GenICam (GenICam Access)			
² See Mounting the heat sink on page 272. ³ Output by <code>DeviceTemperature</code> ⁴ Ensure that the sensor is operated in the temperature range specified by the manufacturer. For any questions, please visit www.alliedvision.com/en/support . ⁵ Temperature values must be observed for the housing and for the cooling area.				

Table 92: Alvium 1800 U-2460m/c specifications (sheet 2 of 2)

Absolute QE

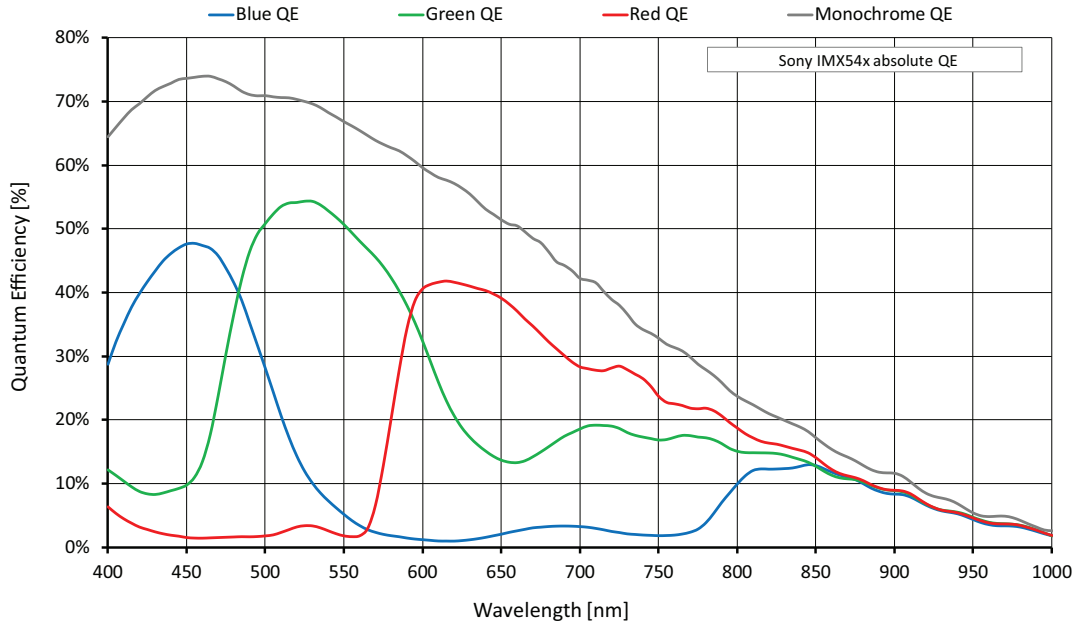

Figure 65: Alvium 1800 U-2460m/c (Sony IMX540) absolute QE

Spectral response

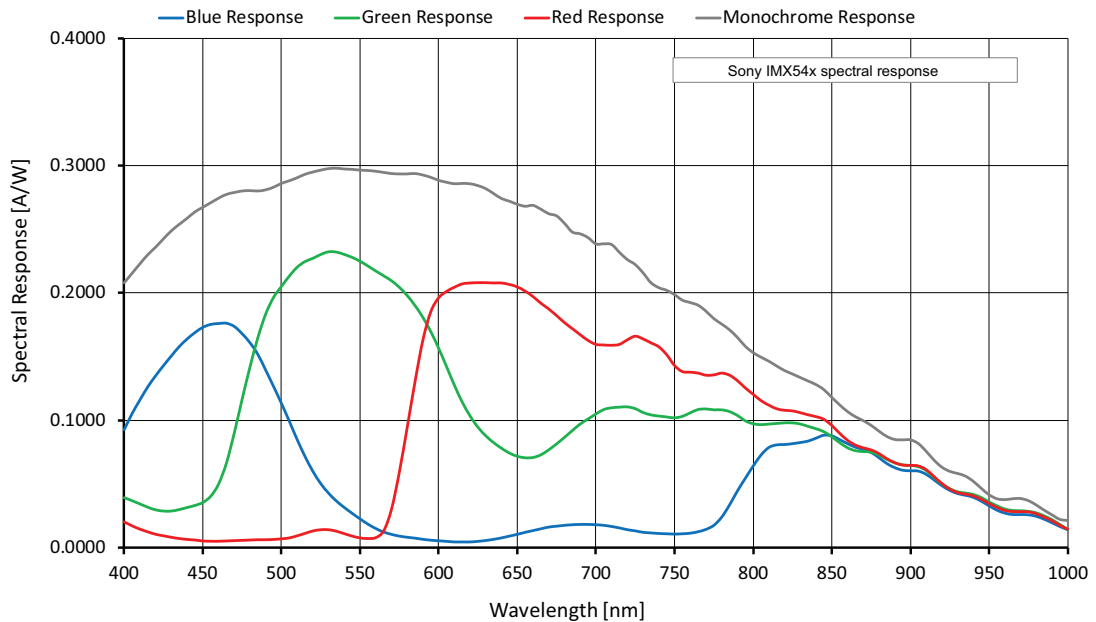

Figure 66: Alvium 1800 U-2460m/c (Sony IMX540) spectral response

ROI frame rates

Values are based on the conditions defined in [Specified values](#) on page 77.

To reach the maximum frame rate available for this setup, the bandwidth for image traffic is 450 MByte/s.

Image format	Width [pixels]	Height [pixels]	ROI area [MP]	Frame rate [fps] ¹		
				450 MByte/s	375 MByte/s	200 MByte/s
Full resolution	5328	4608	24.551	17.6/8.8	14.8/7.4	7.9/4.0
HSXGA	5120	4096	20.972	20.4/10.3	17.2/8.7	9.2/4.6
HXGA	4096	3072	12.583	32.0/16.9	28.4/14.3	15.2/7.6
UHD 4K	3840	2160	8.294	44.6/25.3	42.1/21.3	22.7/11.4
QSXGA	2560	2048	5.243	47.1/39.7	47.1/33.5	35.7/18.0
WQHD	2560	1440	3.686	65.3/55.0	65.3/46.5	49.6/25.0
QXGA	2048	1536	3.146	61.7/61.7	61.7/54.8	58.2/29.4
Full HD	1920	1080	2.074	84.9/84.9	84.9/80.5	84.9/43.1
UXGA	1600	1200	1.92	77.5/77.5		77.5/47.1
WXGA+	1440	900	1.296	99.7/99.7		99.7/67.2
SXGA	1280	1024	1.311	89.4/89.4		89.4/67.8
HD 720	1280	720	0.922	121.5/121.5		121.5/92.2
XGA	1024	768	0.786	115.2/115.2		115.2/109.3
SVGA	800	600	0.48	142.2/142.2		142.2/142.2
VGA	640	480	0.307	171.0/171.0		171.0/171.0
HVGA	480	320	0.154	232.8/232.8		
QVGA	320	240	0.077	284.1/284.1		
HQVGA	240	160	0.038	364.4/364.4		
QQVGA	160	120	0.019	424.4/424.4		
Max. × half	5328	2304	12.276	34.0/17.1	28.7/14.4	15.4/7.7
Max. × min.	5328	8	0.043	513.0/290.3	447.8/249.3	264.1/140.1
Min. × max.	8	4608	0.037	21.8/21.8	21.8/21.8	21.8/21.8
Min. × min.	8	8	64 Px	787.2/787.2	787.2/787.2	787.2/787.2

¹ Mono8 or Bayer...8⁽²⁾ at **SensorBitDepth** = 12-Bit /
 Mono12 or Bayer...12 at **SensorBitDepth** = 12-Bit

² The three dots... represent the colors of a Bayer pixel format, such as in Bayer**RG8**.

Table 93: Alvium 1800 U-2460m/c ROI frame rates

White balance default

Alvium color cameras are balanced for neutral color reproduction with an illumination of 5000 °K (warm daylight). [Table 94](#) shows default values for the red and blue channel by model.

For different illuminations, use auto white balance or adapt the color channel values manually.



Feature description

See the Alvium Features Reference at www.alliedvision.com/en/support/technical-documentation/alvium-usb-documentation.



Exceptions and sensor characteristics

- White balance default does not apply to **monochrome and Pol models**.
- Especially with long exposure times, bright image areas of **e2v EV76C5x Sapphire sensors** may appear slightly pink: At maximum saturation, the output for red and green is 255 as expected, while the output for blue drops down to approximately 240. Therefore, we recommend to slightly underexpose images to reduce this effect.

Alvium model	Sensor model	Red channel value	Blue channel value
1800 U-040c	Sony IMX287	2.360	2.030
1800 U-050c	ON Semiconductor PYTHON 480	1.930	1.500
1800 U-052c	Sony IMX426	2.290	2.000
1800 U-120c	ON Semiconductor AR0135CS	1.760	1.650
1800 U-131c	e2v EV76C560	1.390	1.270
1800 U-158c	Sony IMX273	2.355	2.100
1800 U-192c	e2v EV76C570	1.390	1.270
1800 U-203c	Sony IMX422	2.290	2.000
1800 U-234c	Sony IMX249	2.580	1.810
1800 U-235c	Sony IMX174	2.580	1.810
1800 U-240c	Sony IMX392	2.355	2.100
1800 U-291c	Sony IMX421	2.290	2.000
1800 U-319c	Sony IMX265	2.355	2.100
1800 U-500c	ON Semiconductor AR0521SR	2.120	1.520
1800 U-501c NIR	ON Semiconductor AR0522	1.500	1.770
1800 U-507c	Sony IMX264	2.355	2.100
1800 U-507c Pol	Sony IMX264MYR	Not applicable	
1800 U-508c	Sony IMX250	2.355	2.100
1800 U-508c Pol	Sony IMX250MYR	Not applicable	
1800 U-510c	Sony IMX548	2.870	2.000
1800 U-511c	Sony IMX547	2.870	2.000
1800 U-811c	Sony IMX546	2.870	2.000

Table 94: Alvium default values for color channels (sheet 1 of 2)

Alvium model	Sensor model	Red channel value	Blue channel value
1800 U-895c	Sony IMX267	2.355	2.100
1800 U-1236c	Sony IMX304	2.355	2.100
1800 U-1240c	Sony IMX226	2.620	1.810
1800 U-1242c	Sony IMX545	2.870	2.000
1800 U-1620c	Sony IMX542	2.870	2.000
1800 U-2040c	Sony IMX541	2.870	2.000
1800 U-2050c	Sony IMX183	2.660	1.830
1800 U-2460c	Sony IMX540	2.870	2.000

Table 94: Alvium default values for color channels (sheet 2 of 2)

Standard Alvium: Dimensions and mass

Bare board

Feature	USB 180° (standard orientation)	USB 90°
Dimensions (L × W × H)	[Model specific] × 26 mm × 26 mm	[Model specific] × 30 mm × 26 mm
Mass	15 g	

Table 95: Standard Alvium - bare board dimensions and mass

Open housing 180° (standard orientation)

Open housing	C-Mount	CS-Mount	S-Mount
Flange focal distance, optical	17.526 mm	12.526 mm	12.63 mm
Thread	1"-32tpi UNS-2B	1"-32tpi UNS-2B	M12 × 0.5 mm
Maximum protrusion ¹	13.6 mm	8.6 mm	11.0 mm
Body dimensions (L × W × H) in [mm]	30 × 29 × 29	25 × 29 × 29	25 × 29 × 29
Mass	45 g		

¹ For details, see [Maximum protrusion for front mounts](#).

Table 96: Standard Alvium - open housing 180° dimensions and mass

Open housing 90°

USB 90° open housing	C-Mount	CS-Mount	S-Mount
Flange focal distance, optical	17.526 mm	12.526 mm	12.63 mm
Thread	1"-32tpi UNS-2B	1"-32tpi UNS-2B	M12 × 0.5 mm
Maximum protrusion ¹	13.6 mm	8.6 mm	11.0 mm
Body dimensions (L × W × H) in [mm]	30 × 32 × 29	25 × 32 × 29	25 × 32 × 29
Mass	50 g		

¹ For details, see [Maximum protrusion for front mounts](#).

Table 97: Standard Alvium - open housing 90° dimensions and mass

Closed housing 180° (standard orientation)

Closed housing	C-Mount	CS-Mount	S-Mount
Flange focal distance, optical	17.526 mm	12.526 mm	12.63 mm
Thread	1"-32tpi UNS-2B	1"-32tpi UNS-2B	M12 × 0.5 mm
Maximum protrusion ¹	13.6 mm	8.6 mm	11.0 mm
Body dimensions (L × W × H) in [mm]	38 × 29 × 29	33 × 29 × 29	33 × 29 × 29
Mass ²	60 g		
Mass ³	65 g		

¹ For details, see [Maximum protrusion for front mounts](#).

² Alvium 1800 U-040, -050, -120, -131, -192, -234, -235, -319, -500, -501, -507, -507 Pol

³ Alvium 1800 U-030, -052, -130, -158, -203,-240, -291, -320 VSWIR, -508, -508 Pol, -510, -511,-520 VSWIR, -811, 812, -895, -1236, -1240,-1242, -1620, -2040, -2050, -2460

Table 98: Standard Alvium - closed housing 180° dimensions and mass

Closed housing 90°

USB 90° Closed housing	C-Mount	CS-Mount	S-Mount
Flange focal distance, optical	17.526 mm	12.526 mm	12.63 mm
Thread	1"-32tpi UNS-2B	1"-32tpi UNS-2B	M12 × 0.5 mm
Maximum protrusion ¹	13.6 mm	8.6 mm	11.0 mm
Body dimensions (L × W × H) in [mm]	38 × 32 × 29	33 × 32 × 29	33 × 32 × 29
Mass ²	65 g		
Mass ³	70 g		

¹ For details, see [Maximum protrusion for front mounts](#).

² Alvium 1800 U-040, -050, -120, -131, -192, -234, -235, -319, -500, -501, -507, -507 Pol

³ Alvium 1800 U-030, -052, -130, -158, -203,-240, -291, -320 VSWIR, -508, -508 Pol, -510, -511,-520 VSWIR, -811, 812, -895, -1236, -1240,-1242, -1620, -2040, -2050, -2460

Table 99: Standard Alvium - closed housing 90° dimensions and mass

Standard Alvium: Technical drawings

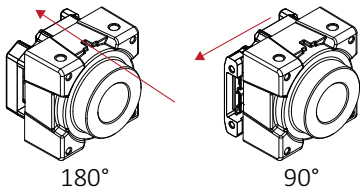

USB interface connector position

- **180°**: The connector is at the camera backside. In the naming for camera hardware options, this option is **not mentioned**.
- **90°**: The connector is at the camera left side, as seen from the lens mount. In the naming for camera hardware options, this option is named **90°**.

Standard Alvium USB cameras are available as shown in the following table:

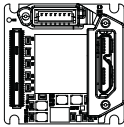
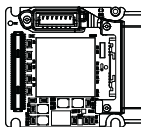
Bare Board	
180°	90°
 <p>page 221</p>	 <p>page 221</p>

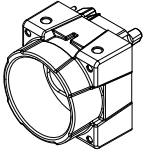
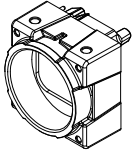
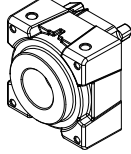
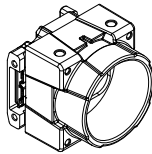
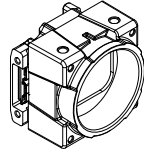
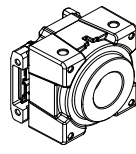
Open Housing					
180°			90°		
C-Mount	CS-Mount	S-Mount	C-Mount	CS-Mount	S-Mount
 <p>page 223</p>	 <p>page 224</p>	 <p>page 225</p>	 <p>page 226</p>	 <p>page 227</p>	 <p>page 228</p>

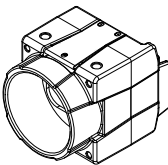
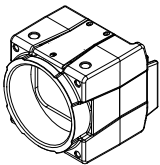
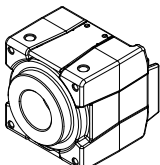
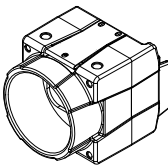
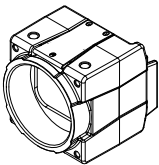
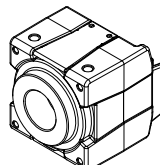
Closed Housing					
180°			90°		
C-Mount	CS-Mount	S-Mount	C-Mount	CS-Mount	S-Mount
 <p>page 229</p>	 <p>page 230</p>	 <p>page 231</p>	 <p>page 232</p>	 <p>page 233</p>	 <p>page 234</p>

Bare Board 180° (standard Alvium)

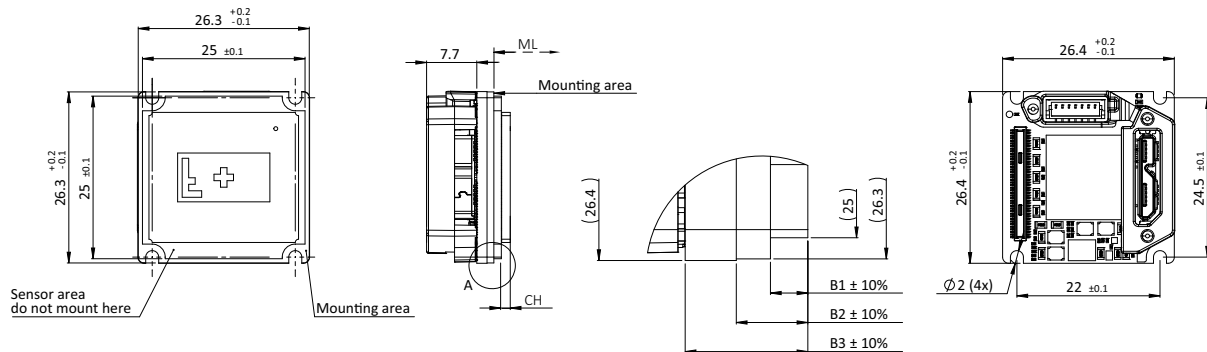

Figure 67: Bare Board 180° (standard Alvium) dimensions

Bare Board 90° (standard Alvium)

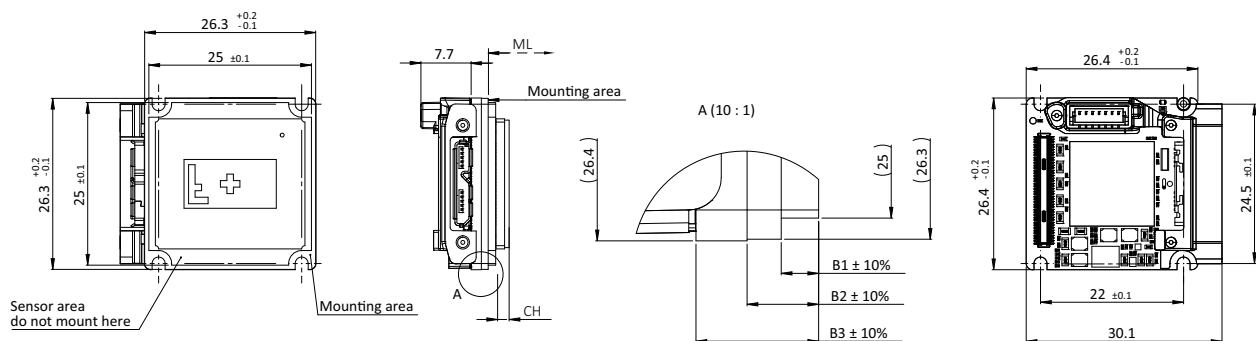

Figure 68: Bare Board 90° (standard Alvium) dimensions

Values in Bare Board drawings

Dimensions that are common between different models are shown in [Figure 67](#) for **Bare Board Standard** and in [Figure 68](#) for **Bare Board 90°**.

Model specific dimensions are listed in [Table 100](#). **Mechanical length** (ML) defines the mechanical distance from the mounting area to the lens mount front flange, without optical filter. **Components height** (CH) relates to the electronic components with maximum height, in some cases the sensor.



Mechanical length for CS-Mount and S-Mount

Mechanical length for CS-Mount and S-Mount is:

[C-Mount value] – 5 mm

Camera model	ML: Mechanical length* for C-Mount	CH: Components height, incl. the sensor	B1: Board thickness	B2: Board thickness	B3: Board thickness
Alvium 1800 U-030 VSWIR	19.613 mm	2.87 mm	1.25 mm	2.20 mm	3.75 mm
Alvium 1800 U-040m/c	19.879 mm	2.27 mm	1.20 mm	2.20 mm	3.75 mm
Alvium 1800 U-050m/c	19.604 mm	1.40 mm	1.75 mm	3.00 mm	4.55 mm
Alvium 1800 U-052m/c	19.713 mm	2.87 mm	1.10 mm	2.20 mm	3.75 mm
Alvium 1800 U-120m/c	19.689 mm	1.44 mm	1.25 mm	2.40 mm	3.95 mm
Alvium 1800 U-130 VSWIR	19.613 mm	2.87 mm	1.25 mm	2.20 mm	3.75 mm
Alvium 1800 U-131m/c	19.845 mm	2.59 mm	1.00 mm	2.00 mm	3.55 mm
Alvium 1800 U-158m/c	19.879 mm	2.27 mm	1.20 mm	2.20 mm	3.75 mm
Alvium 1800 U-192m/c	19.845 mm	2.59 mm	1.00 mm	2.00 mm	3.55 mm
Alvium 1800 U-203m/c	19.713 mm	2.87 mm	1.10 mm	2.20 mm	3.75 mm
Alvium 1800 U-234m/c	19.713 mm	2.87 mm	1.10 mm	2.20 mm	3.75 mm
Alvium 1800 U-235m/c	19.713 mm	2.87 mm	1.10 mm	2.20 mm	3.75 mm
Alvium 1800 U-240m/c	19.929 mm	2.27 mm	1.25 mm	2.20 mm	3.75 mm
Alvium 1800 U-291m/c	19.713 mm	2.87 mm	1.10 mm	2.20 mm	3.75 mm
Alvium 1800 U-319m/c	19.929 mm	2.27 mm	1.25 mm	2.20 mm	3.75 mm
Alvium 1800 U-320 VSWIR	19.713 mm	2.83 mm	1.10 mm	2.20 mm	3.75 mm
Alvium 1800 U-500m/c	19.739 mm	1.67 mm	1.30 mm	2.40 mm	3.95 mm
Alvium 1800 U-501m/c NIR	19.739 mm	1.67 mm	1.30 mm	2.40 mm	3.95 mm
Alvium 1800 U-507m/c	19.929 mm	2.27 mm	1.25 mm	2.20 mm	3.75 mm
Alvium 1800 U-507m/c Pol	19.929 mm	2.27 mm	1.25 mm	2.20 mm	3.75 mm
Alvium 1800 U-508m/c	19.929 mm	2.27 mm	1.25 mm	2.20 mm	3.75 mm
Alvium 1800 U-508m/c Pol	19.929 mm	2.27 mm	1.25 mm	2.20 mm	3.75 mm
Alvium 1800 U-510m/c	19.713mm	2.20 mm	1.10 mm	2.20 mm	3.75 mm
Alvium 1800 U-511m/c	19.613 mm	2.88 mm	1.00 mm	2.20 mm	3.75 mm
Alvium 1800 U-530 VSWIR	19.713 mm	2.83 mm	1.10 mm	2.20 mm	3.75 mm
Alvium 1800 U-811m/c	19.613 mm	2.88 mm	1.00 mm	2.20 mm	3.75 mm
Alvium 1800 U-812 UV	19.610 mm	2.88 mm	1.00 mm	2.20 mm	3.75 mm
Alvium 1800 U-895m/c	19.829 mm	2.27 mm	1.15 mm	2.20 mm	3.75 mm
Alvium 1800 U-1236m/c	19.829 mm	2.27 mm	1.15 mm	2.20 mm	3.75 mm
Alvium 1800 U-1240m/c	19.763 mm	2.20 mm	1.15 mm	2.20 mm	3.75 mm
Alvium 1800 U-1242m/c	19.613 mm	2.88 mm	1.00 mm	2.20 mm	3.75 mm
Alvium 1800 U-1620m/c	19.613 mm	2.88 mm	1.00 mm	2.20 mm	3.75 mm
Alvium 1800 U-2040m/c	19.613 mm	2.88 mm	1.00 mm	2.20 mm	3.75 mm
Alvium 1800 U-2050m/c	19.663 mm	2.87 mm	1.05 mm	2.20 mm	3.75 mm
Alvium 1800 U-2460m/c	19.613 mm	2.88 mm	1.00 mm	2.20 mm	3.75 mm

* Theoretical values

Table 100: Bare Board and Bare Board 90° (standard Alvium and Alvium Flex) model specific dimensions and nominal values

Open Housing C-Mount 180° (standard Alvium)

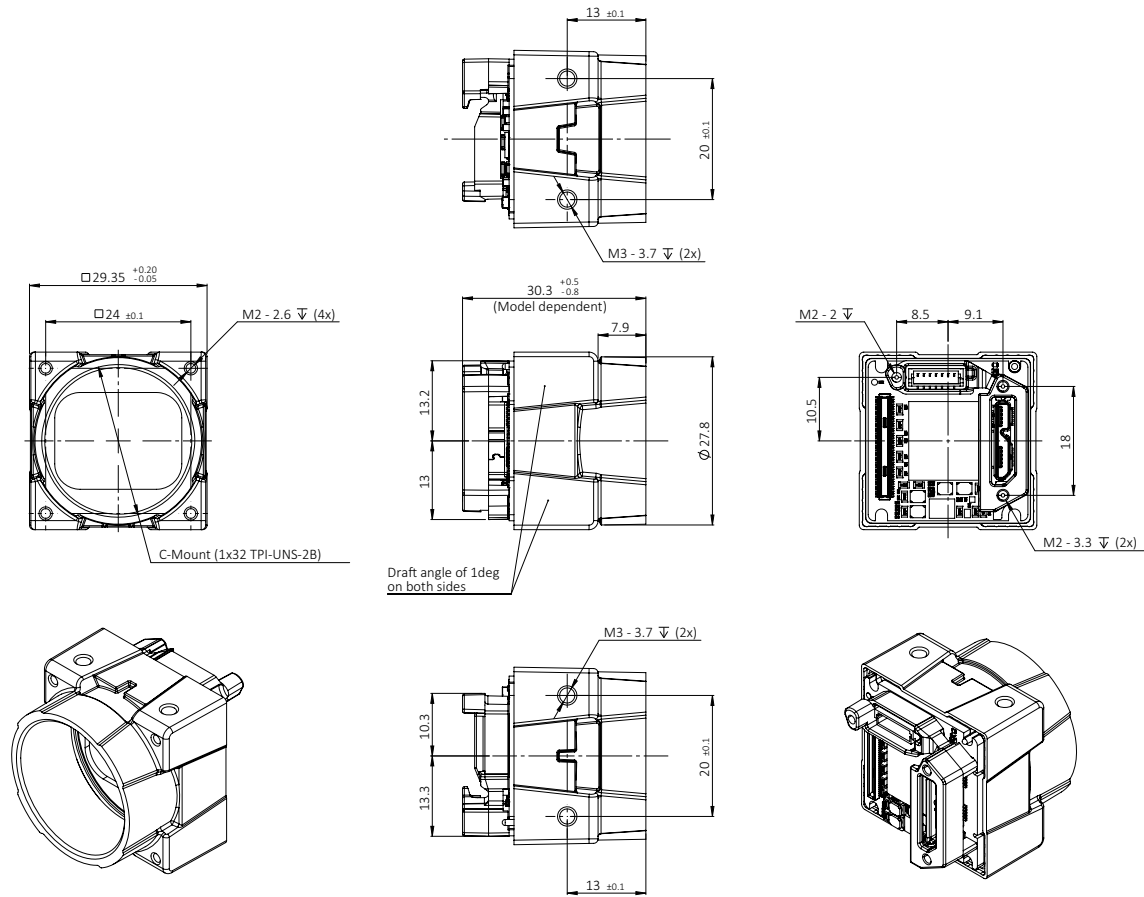

Figure 69: Open Housing C-Mount 180° (standard Alvium) dimensions

Open Housing CS-Mount 180° (standard Alvium)

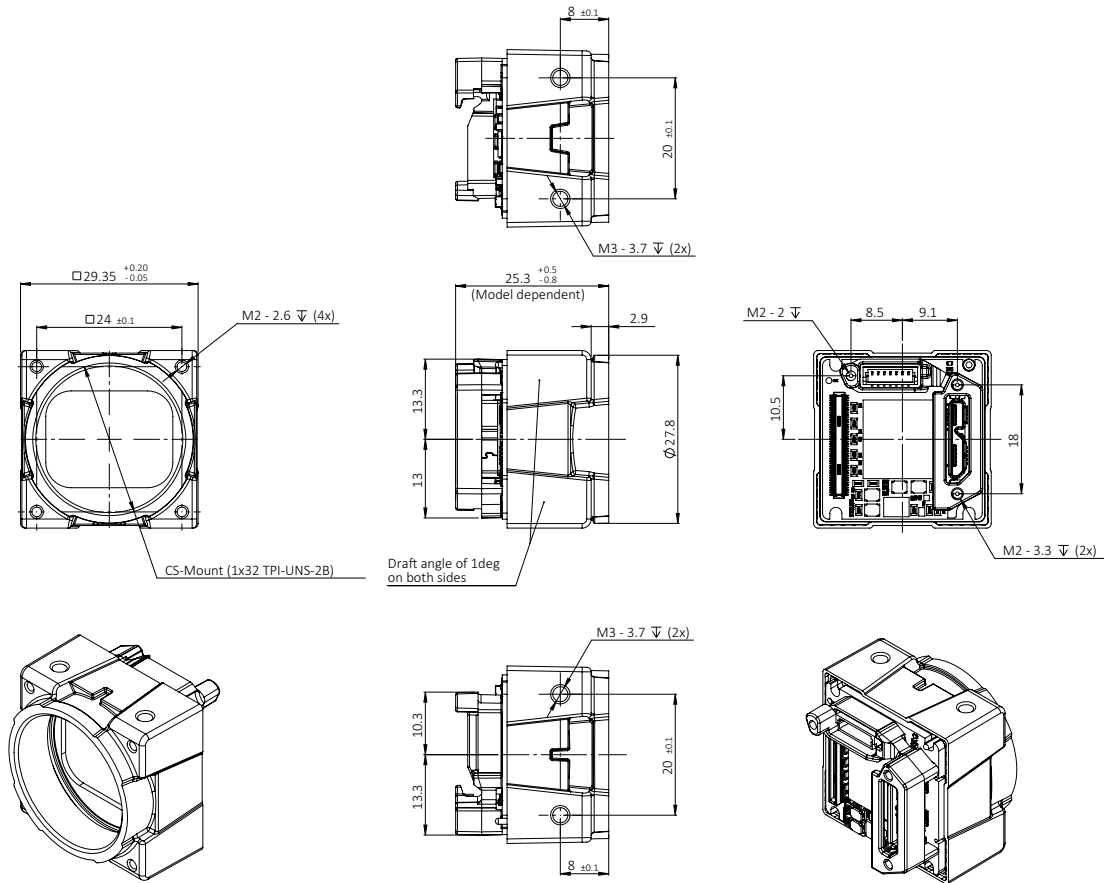

Figure 70: Open Housing CS-Mount 180° (standard Alvium) dimensions

Open Housing S-Mount 180° (standard Alvium)

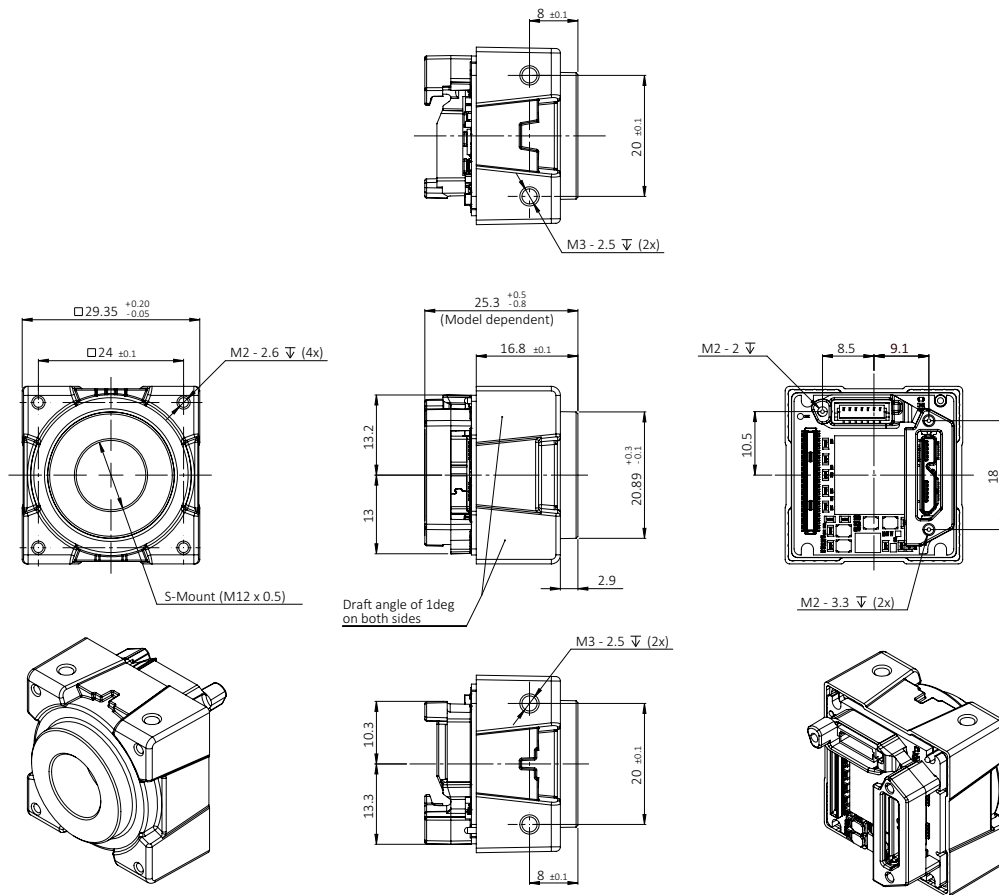

Figure 71: Open Housing S-Mount 180° (standard Alvium) dimensions

Open Housing C-Mount 90° (standard Alvium)

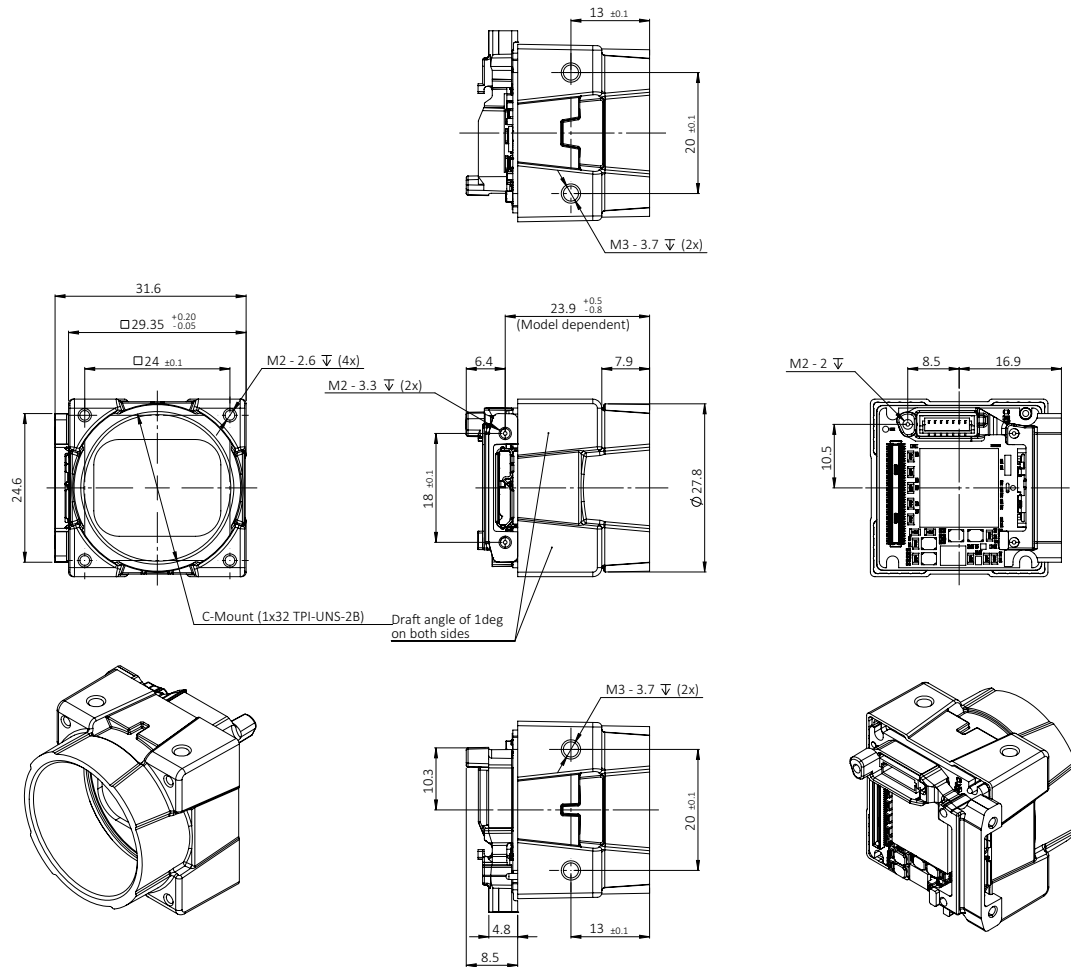

Figure 72: Open Housing C-Mount 90° (standard Alvium) dimensions

Open Housing CS-Mount 90° (standard Alvium)

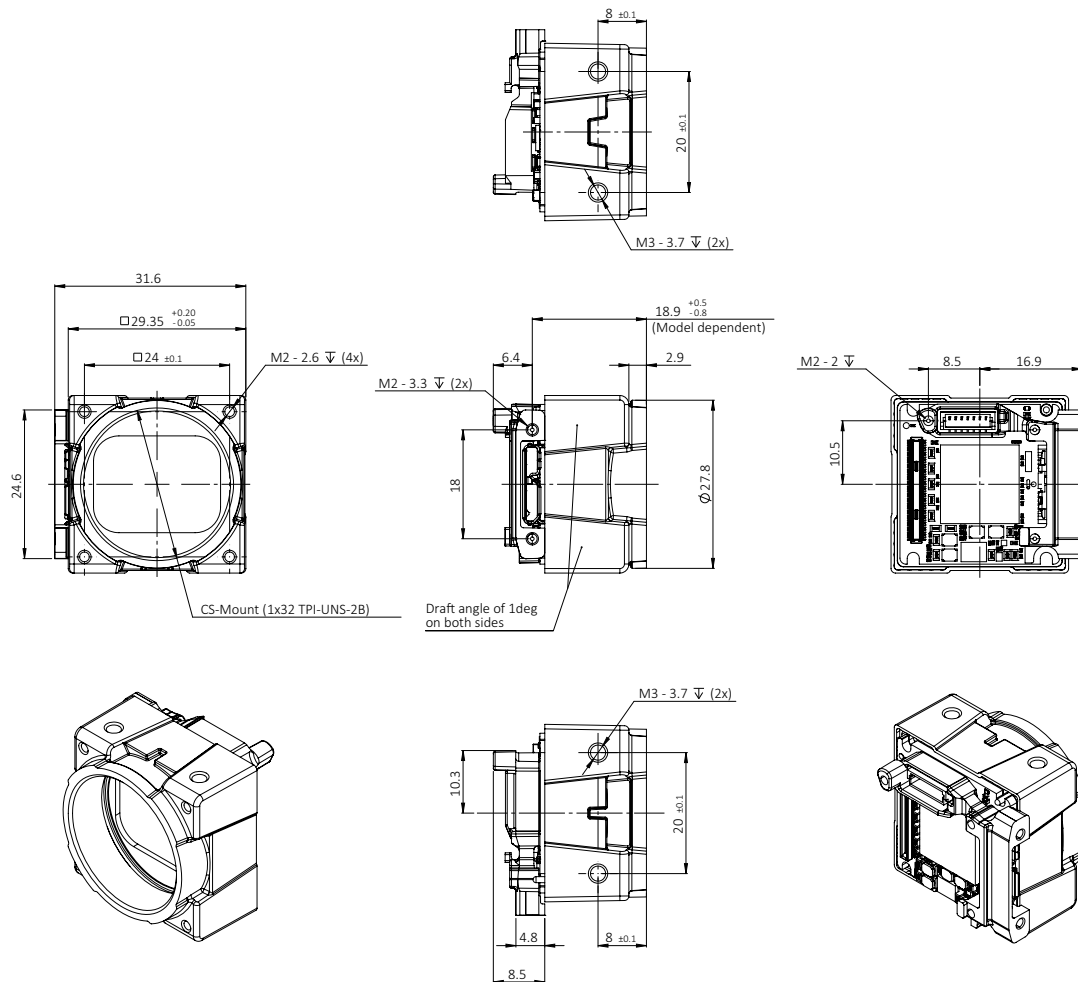

Figure 73: Open Housing CS-Mount 90° (standard Alvium) dimensions

Open Housing S-Mount 90° (standard Alvium)

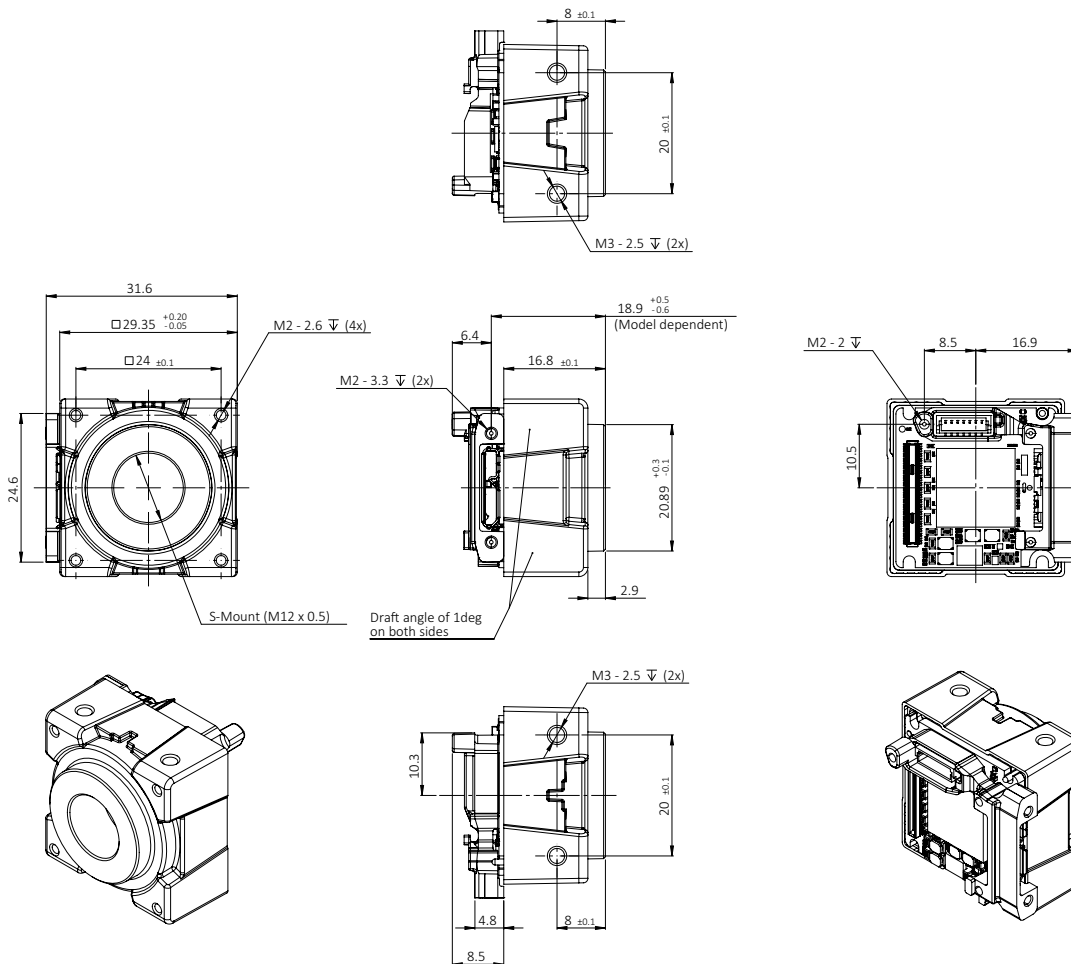

Figure 74: Open Housing S-Mount 90° (standard Alvium) dimensions

Closed Housing C-Mount 180° (standard Alvium)

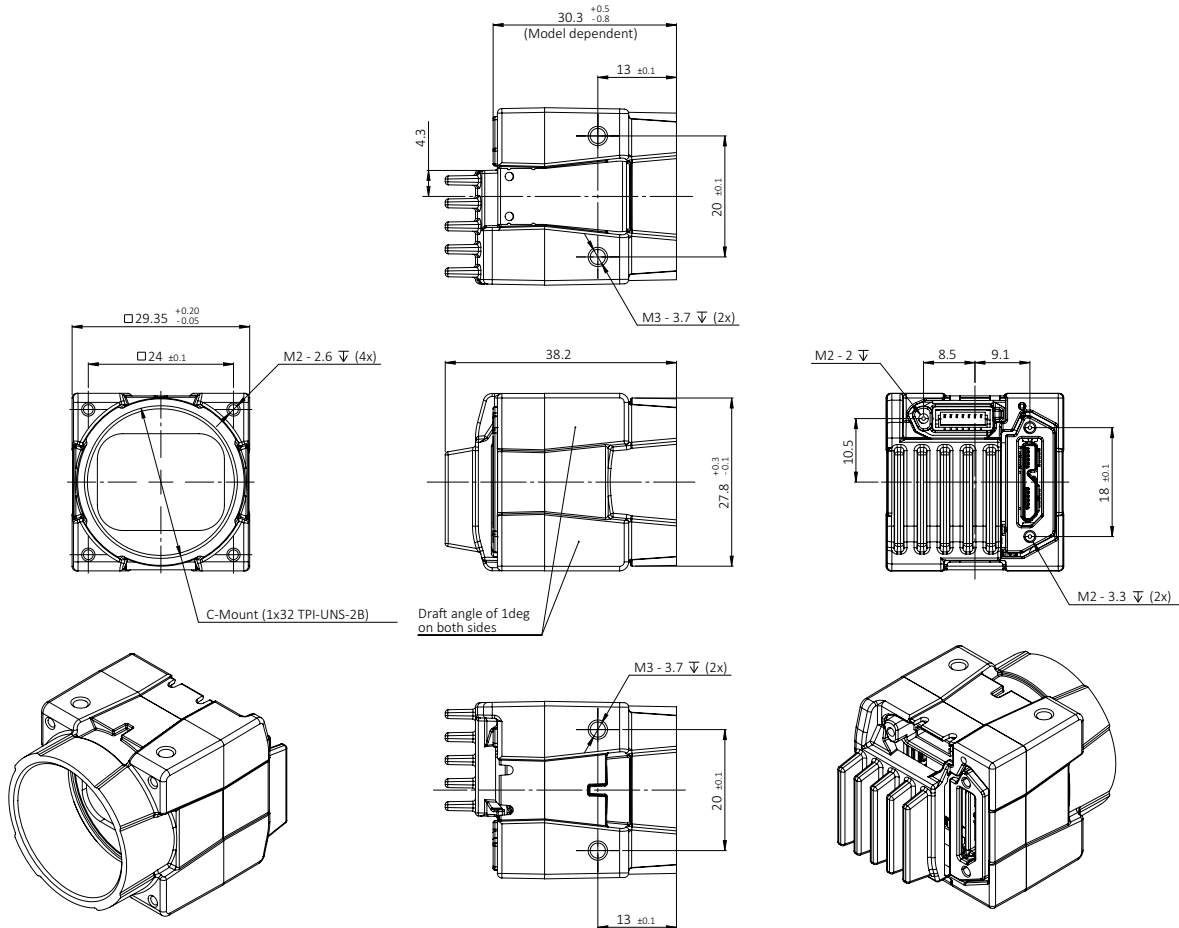

Figure 75: Closed Housing C-Mount 180° (standard Alvium) dimensions

Closed Housing CS-Mount 180° (standard Alvium)

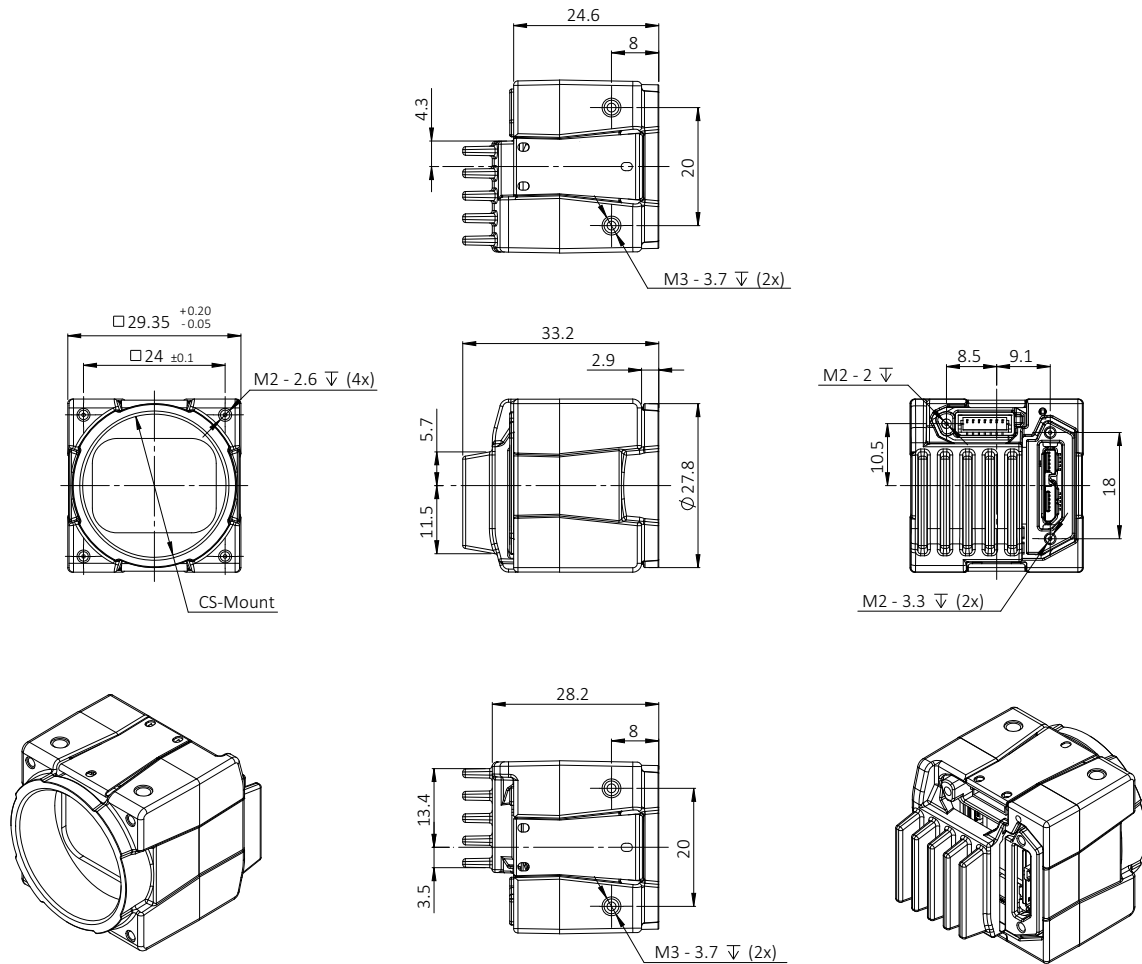

Figure 76: Closed Housing CS-Mount 180° (standard Alvium) dimensions

Closed Housing S-Mount 180° (standard Alvium)

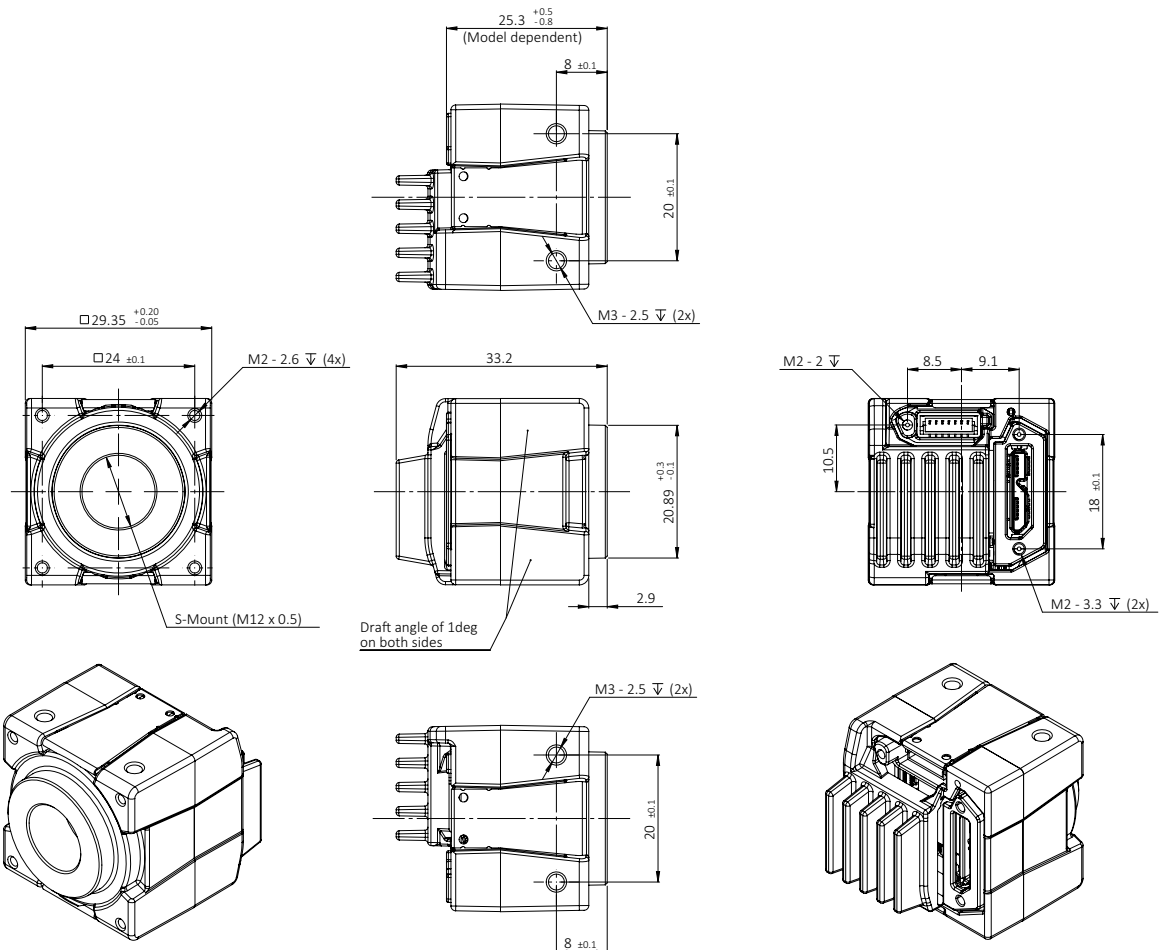

Figure 77: Closed Housing S-Mount 180° (standard Alvium) dimensions

Closed Housing C-Mount 90° (standard Alvium)

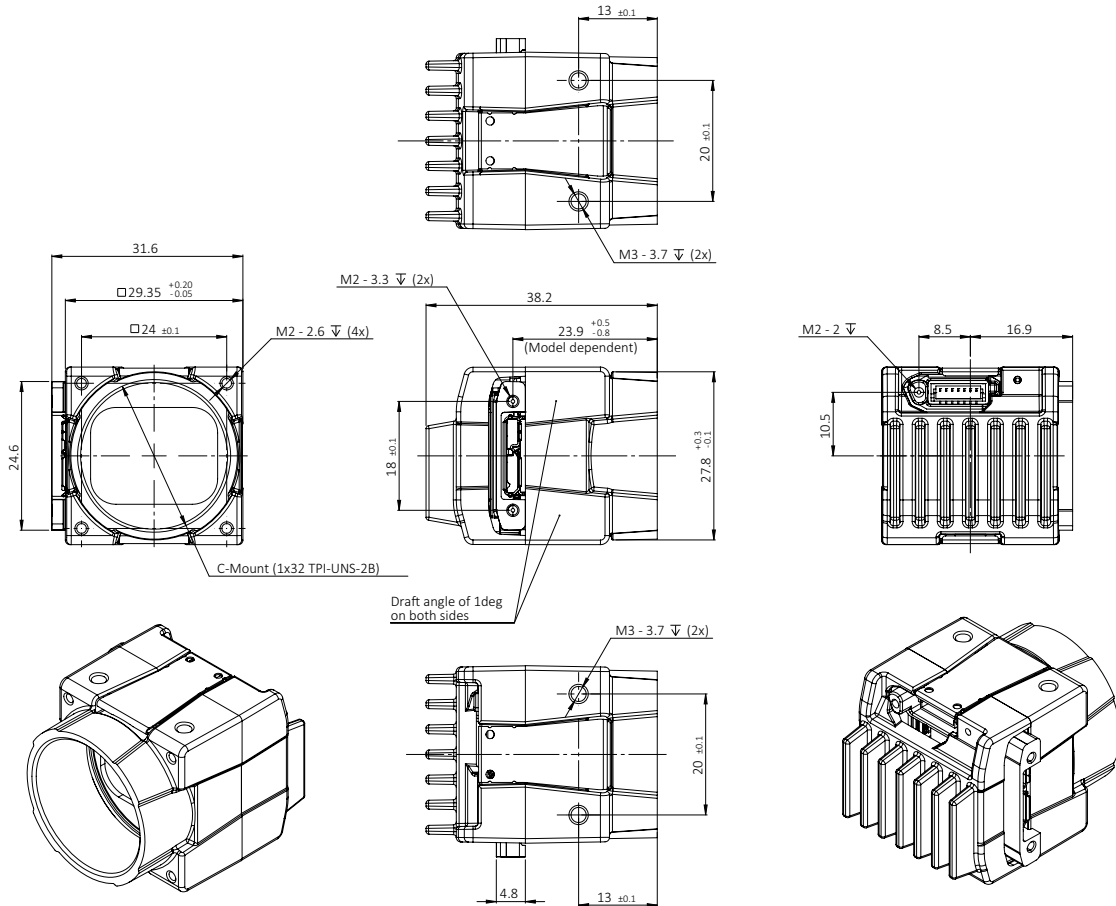

Figure 78: Closed Housing C-Mount 90° (standard Alvium) dimensions

Closed Housing CS-Mount 90° (standard Alvium)

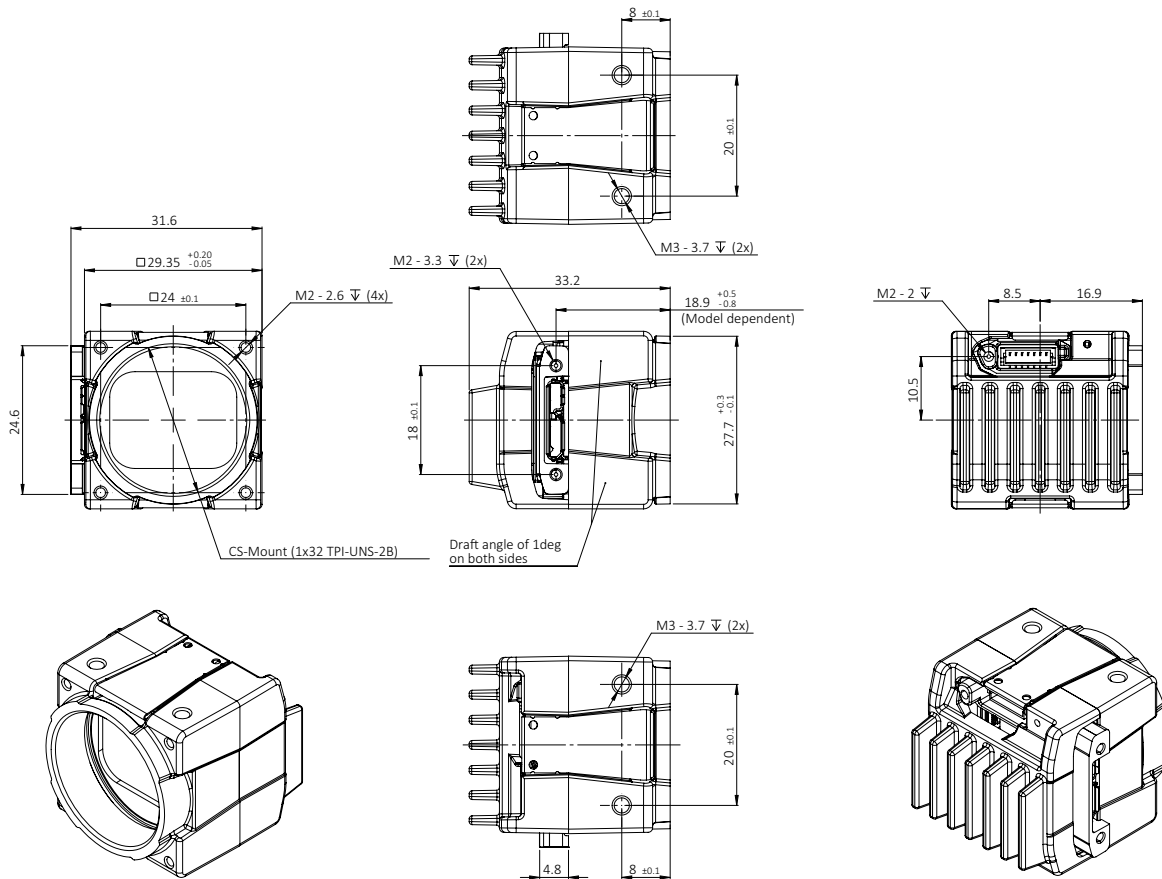

Figure 79: Closed Housing CS-Mount 90° (standard Alvium) dimensions

Closed Housing S-Mount 90° (standard Alvium)

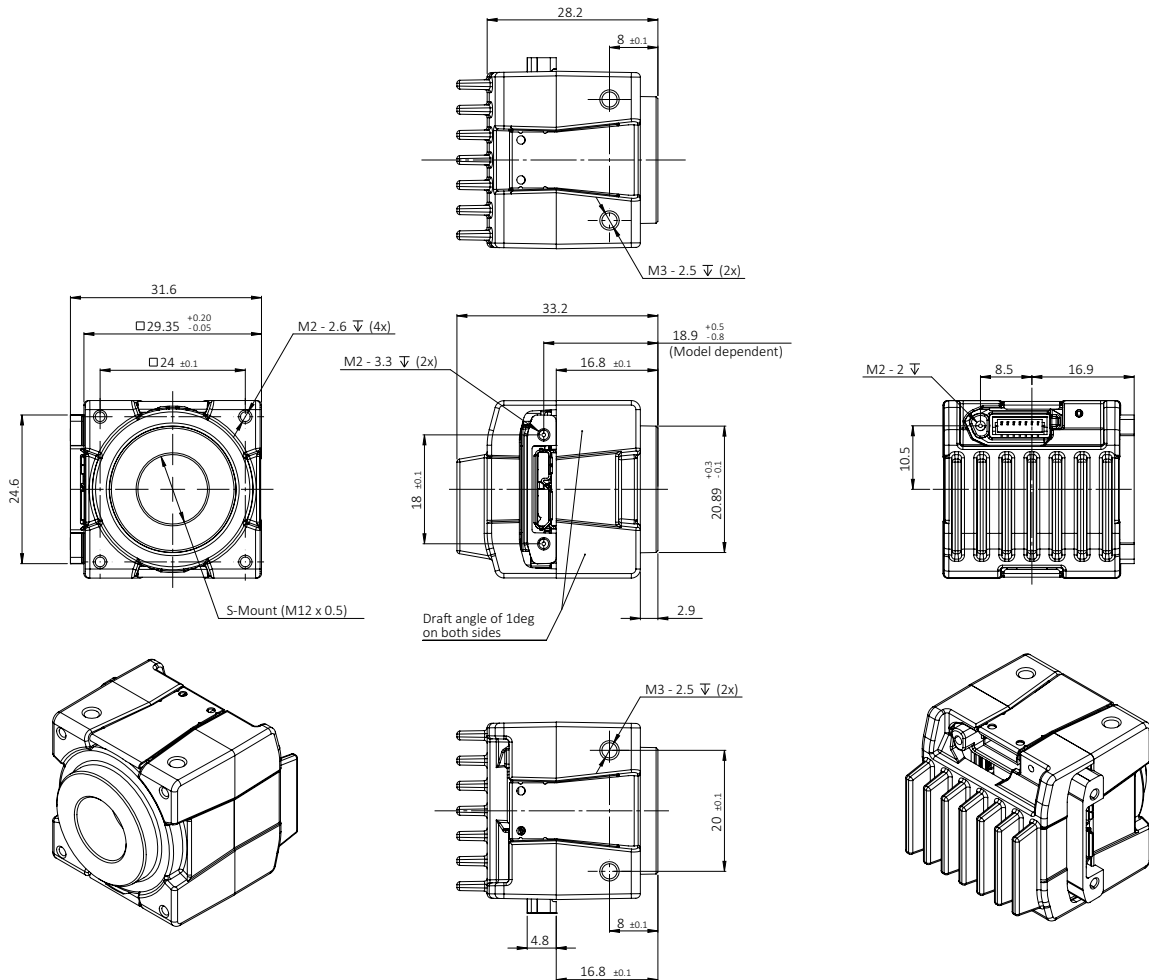

Figure 80: Closed Housing S-Mount 90° (standard Alvium) dimensions

Alvium Flex: Dimensions and mass

Bare board

Feature	Specification
Dimensions (L × W × H)	[Model specific] × 26 mm × 26 mm
Mass	10 g

Table 101: Alvium Flex - bare board dimensions and mass

Open housing

Open housing	C-Mount	CS-Mount	S-Mount
Flange focal distance, optical	17.526 mm	12.526 mm	12.63 mm
Thread	1"-32tpi UNS-2B	1"-32tpi UNS-2B	M12 × 0.5 mm
Maximum protrusion ¹	13.6 mm	8.6 mm	11.0 mm
Body dimensions (L × W × H) in [mm]	25 × 29 × 29	20 × 29 × 29	20 × 29 × 29
Mass	40 g		

¹ For details, see [Maximum protrusion for front mounts](#).

Table 102: Alvium Flex - open housing dimensions and mass

Alvium Flex: Technical drawings

Alvium USB Flex cameras are available with the following housing options:

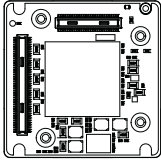
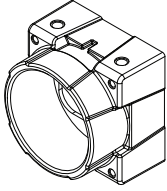
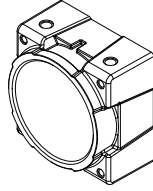
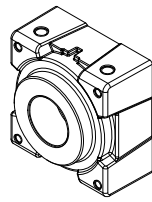
				
Option	Bare Board	Open Housing C-Mount	Open Housing CS-Mount	Open Housing S-Mount
Page	236	237	238	239

Bare Board (Alvium Flex)

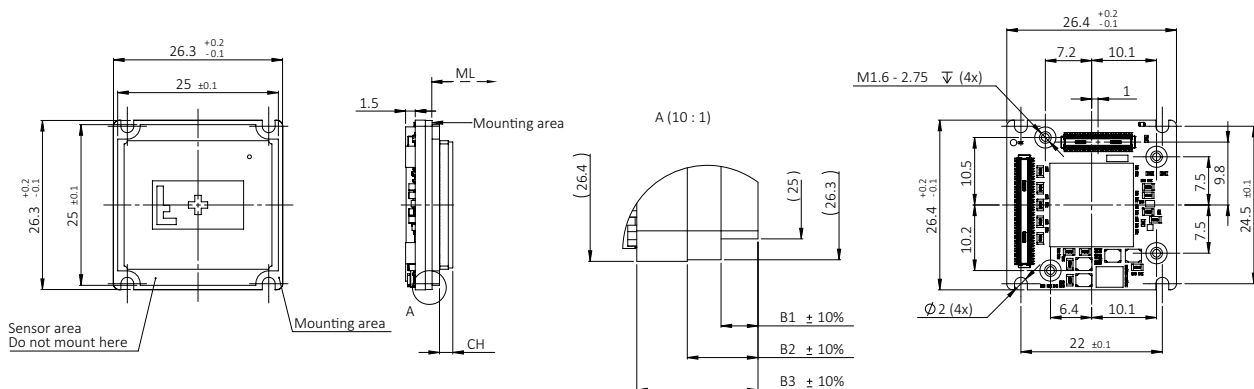

Figure 81: Bare Board (Alvium Flex) dimensions

Dimensions that are common between different models are shown in [Figure 81](#). Model specific dimensions are listed in [Table 100](#). **Mechanical length** (ML) defines the mechanical distance from the mounting area to the lens mount front flange, without optical filter. **Components height** (CH) relates to the electronic components with maximum height, in some cases the sensor.

Open Housing C-Mount (Alvium Flex)

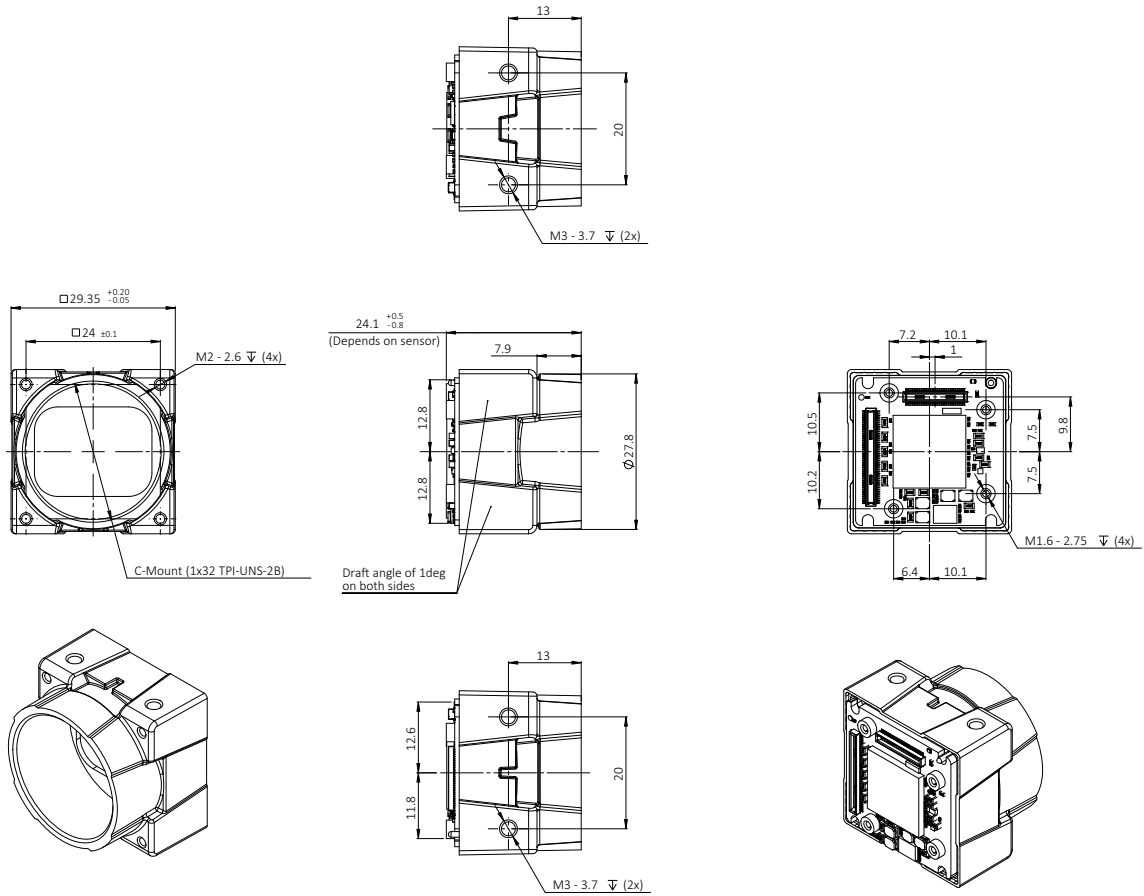

Figure 82: Open Housing C-Mount (Alvium Flex) dimensions

Open Housing CS-Mount (Alvium Flex)

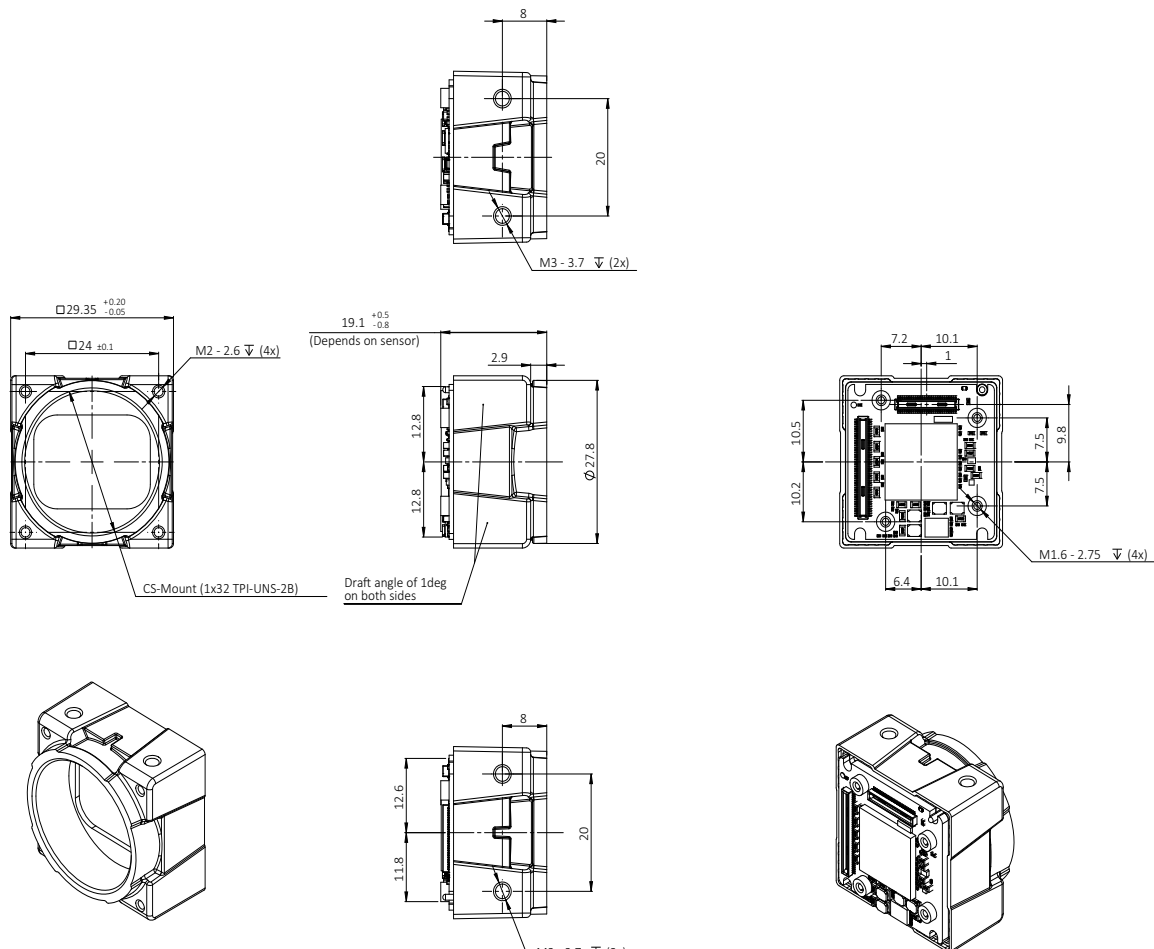

Figure 83: Open Housing CS-Mount (Alvium Flex) dimensions

Open Housing S-Mount (Alvium Flex)

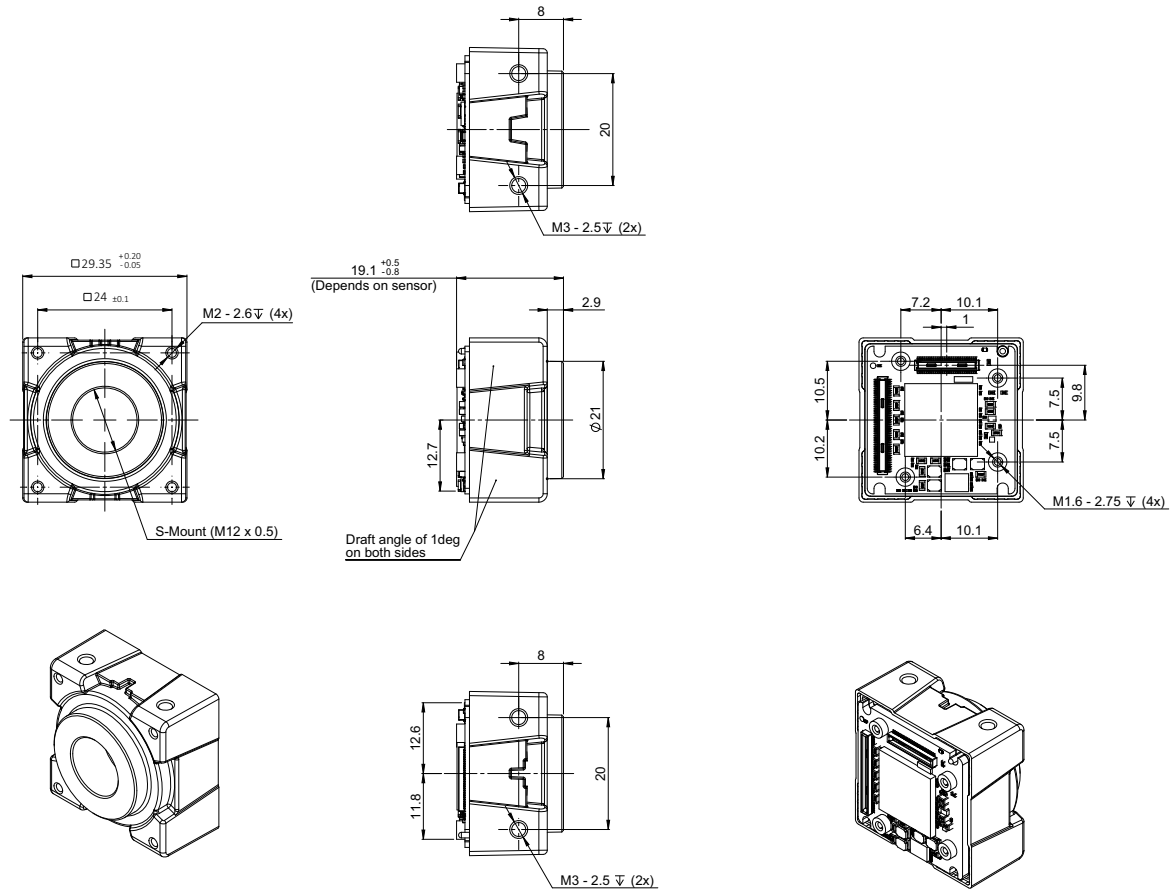

Figure 84: Open Housing S-Mount (Alvium Flex) dimensions

Alvium Frame: Dimensions and mass

Frame cameras	Frame 180°	Frame 90°
Flange focal distance, optical	3.576 mm	
Front hole diameter	24.5 mm	
Maximum protrusion	1.5 mm	
Body dimensions (L × W × H)	16.3 mm × 29 mm × 29 mm	16.3 mm × 31.4 mm × 29 mm
Mass	20 g	25 g

Table 103: Housing dimensions and mass (Alvium Frame)

Alvium Frame: Technical drawings

Alvium Frame 180°

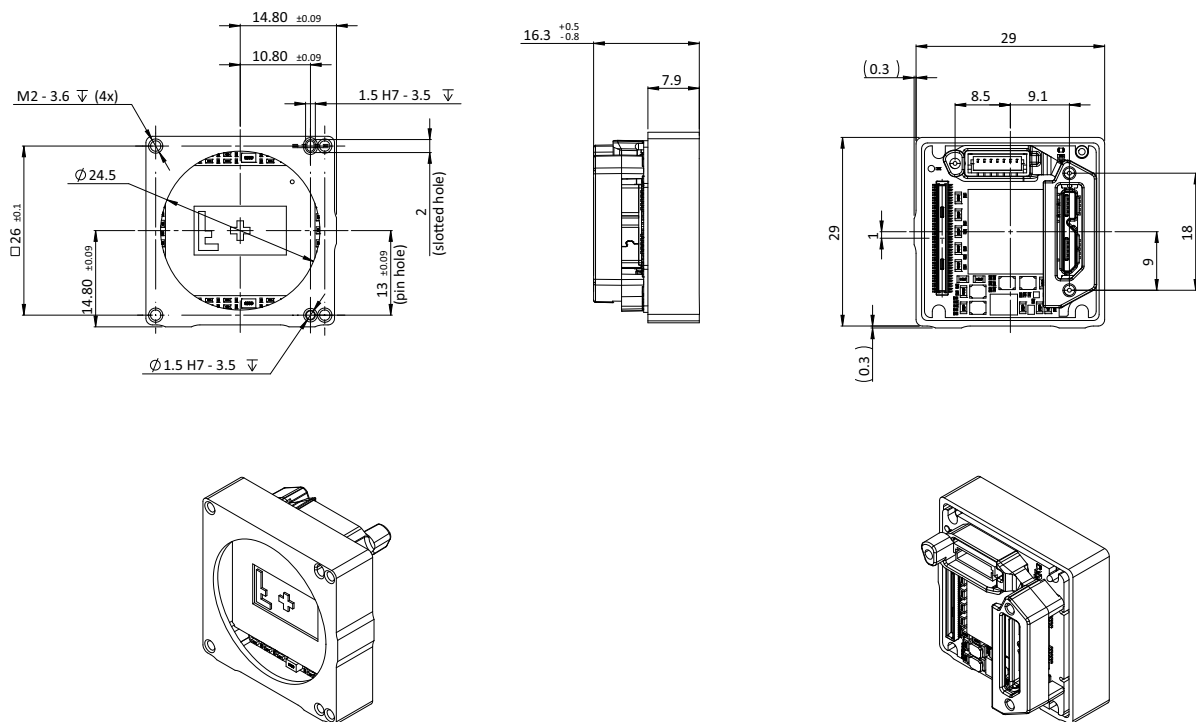

Figure 85: Alvium Frame 180° dimensions

Alvium Frame 90°

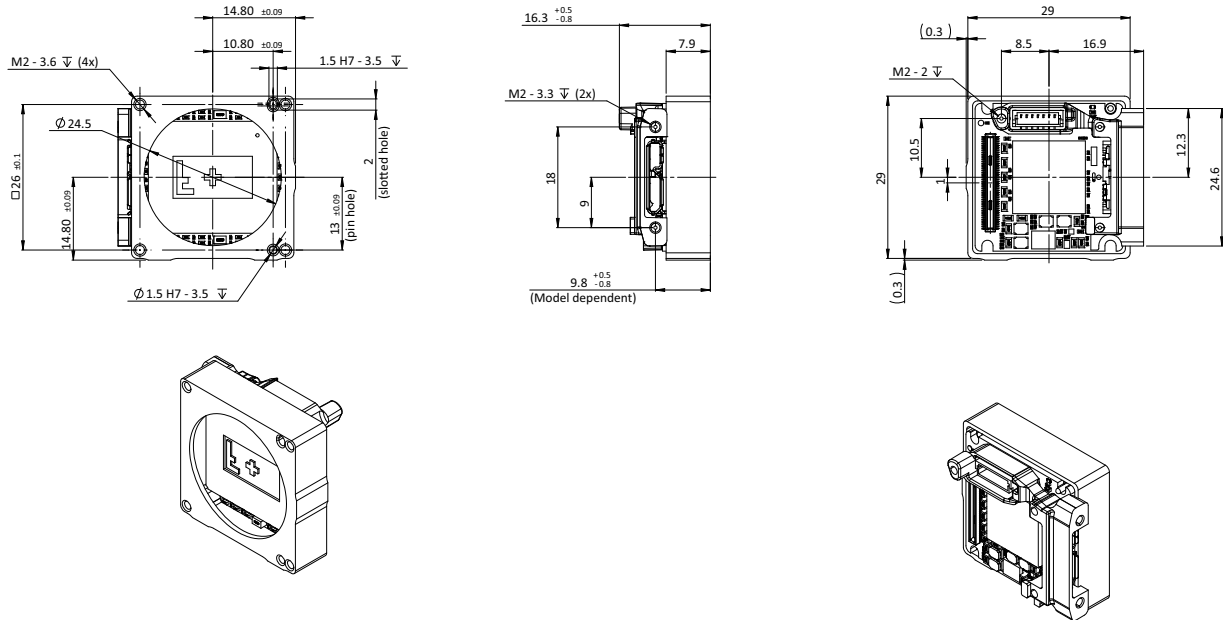

Figure 86: Alvium Frame 90° dimensions

Alvium Frame Flex: Dimensions and mass

Frame cameras	Frame Flex
Flange focal distance, optical	3.576 mm
Front hole diameter	24.5 mm
Maximum protrusion ¹	1.5 mm
Body dimensions (L × W × H)	10.1 mm × 29 mm × 29 mm
Mass	15 g

Table 104: Housing dimensions and mass (Alvium Frame Flex)

Alvium Frame Flex: Technical drawings

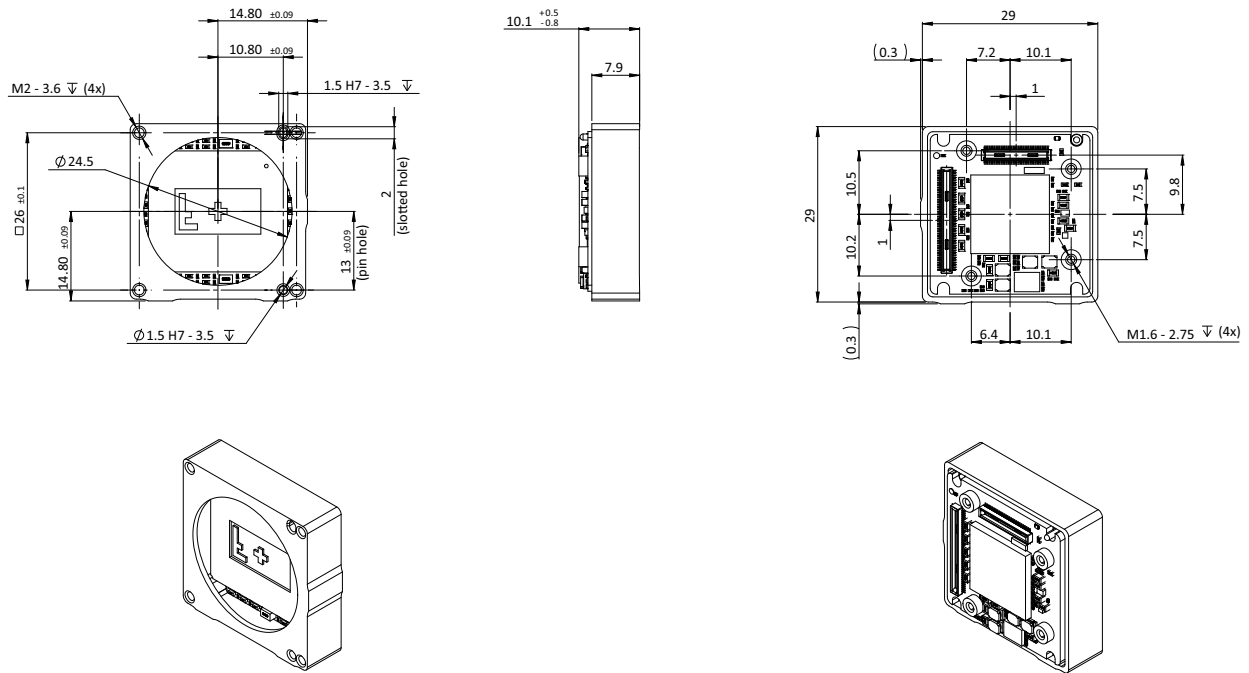

Figure 87: Alvium Frame Flex dimension

Maximum protrusion for front mounts



No need to readjust lens mounts

Alvium USB camera mounts are adjusted with high precision during manufacturing. Construction ensures permanent accuracy without need to readjust.

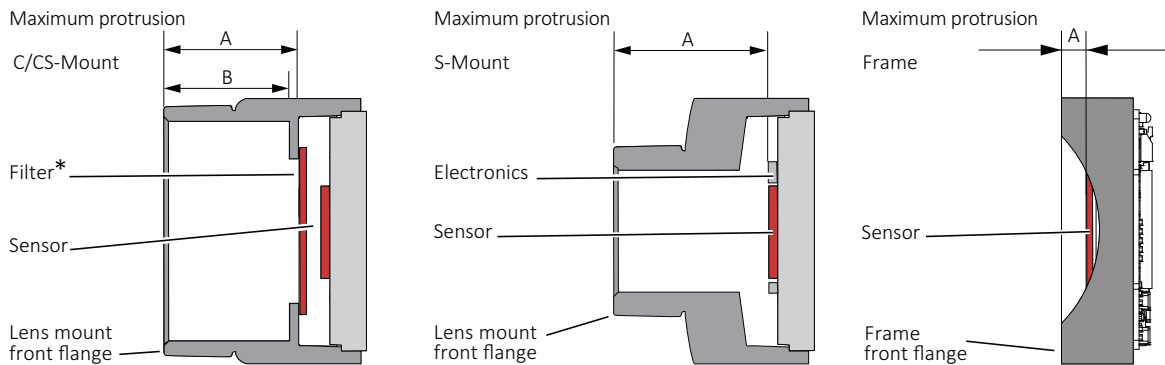

*Only color models are equipped with an IR cut filter

Figure 88: Maximum protrusion CS-Mount and C-Mount, S-Mount, Frame

Figure 88 shows schematics for maximum protrusion of objects (typically lenses), Table 105 shows values for maximum protrusion.



NOTICE

Damage to sensor, optics, or electronics by unsuitable lenses or objects

The sensor, filter, lens, or camera electronics can be damaged if an object (typically a lens) exceeding maximum protrusion is mounted to the camera.

- Use lenses with less than the allowed maximum protrusion, see [Table 105](#).
- Mount objects with less than the allowed maximum protrusion, see [Table 105](#).
- See [Mounting the lens](#) on page 279.
- For S-Mount lenses, see [Mounting and focusing S-Mount lenses](#) on page 280.

Mount	Maximum protrusion
C-Mount	13.6 mm
CS-Mount	8.6 mm
S-Mount	11.0 mm
Frame	1.5 mm

Table 105: Alvium USB cameras maximum protrusion

IR cut filter

Table 106 shows which Alvium models are equipped with an IR cut filter. The filter is permanently installed and cannot be removed.

Color or monochrome model	C-Mount	CS-Mount	S-Mount	Bare Board	Frame
Color	Type IRC 625 colored glass IR cut filter			No filter	
Monochrome and VSWIR	No filter				

Table 106: Optical filter availability

Cameras **without** IR cut filter have a higher sensitivity for low-light imaging. Moreover, spectral sensitivity is increased.

Cameras **with** IR cut filter are more accurate in reproduction of color, contrast, and sharpness, as the filter absorbs near-IR wavelengths. See Figure 89 for filter transmission.



Spectral transmission values

The following curve shows typical transmission for type IRC 625 colored glass IR cut filter. Values may vary slightly by filter lot.

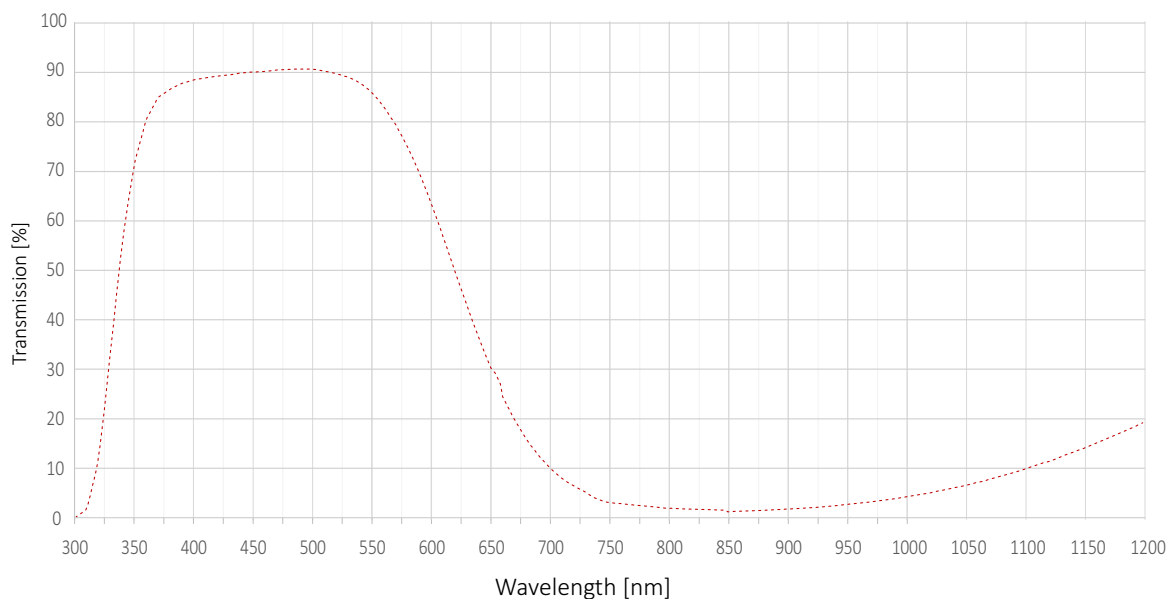

Figure 89: Type IRC 625 colored glass filter spectral transmission (exemplary curve)



S-Mount lenses with IR cut design

For improved image quality, we recommend using S-Mount lenses that are IR- optimized or that have IR cut coating. See the S-Mount Lenses User Guide at [www.alliedvision.com/fileadmin/content/documents/products/accessories/lenses/Allied_Vision/Data Sheet/S-Mount-Lenses_User-Guide.pdf](http://www.alliedvision.com/fileadmin/content/documents/products/accessories/lenses/Allied_Vision/Data_Sheet/S-Mount-Lenses_User-Guide.pdf).

Sensor position accuracy



Sensor alignment for bare board cameras

The sensors in Alvim bare board cameras are not aligned to a lens mount. You must align these cameras into housings individually, which can be difficult and expensive. As a possible solution, Alvim Frame cameras provide alignment areas and holes to fit into individual housings, see [Alvim Frame- use your own optical mount](#) on page 19.

Housed standard and Flex cameras: Sensor shift and rotation

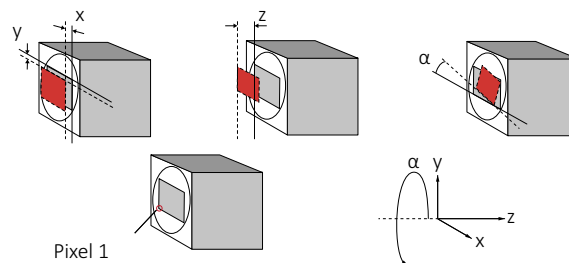

Gray rectangle: Reference sensor position **Red rectangle:** Current position
Straight line: Reference edge **Dotted line:** Current reference edge

The orientation of the z-axis deviates from scientific conventions to define tolerances of the flange focal distance.

Figure 90: Sensor shift and rotation

The following table defines the manufacturing accuracy for sensor positioning with housed standard and Flex cameras.

Criteria	Subject	Properties
Alignment method		Optical alignment of the photosensitive sensor area into the camera front module (lens mount front flange)
Reference Points	Sensor	Center of the pixel area (photo sensitive cells)
	Camera	Center of the lens mount
Accuracy	x/y-axis ¹	±150 µm (sensor shift)
	z	0 to -100 µm (optical back focal length)
	α ¹	±0.5 deg (sensor rotation as the deviation from the parallel to the camera bottom)

¹ We cannot measure or guarantee these values for S-Mount hardware options that are manufactured on customer request for: Alvim 1800 U-052, -203, -234, -235, -291, -320 VSWIR, -507, -507 Pol, -508, -508 Pol, -511, -530 VSWIR, -811, -812 UV, -895, -1236, -1242, -1620, -2040, -2050, -2460.

Table 107: Alvim USB cameras, criteria of sensor position accuracy

Values for Alvium Frame cameras

For sensor shift and rotation with Alvium Frame cameras, see [Housed Alvium Frame: Sensor shift and rotation](#) on page 246. For sensor tilt, see [Housed Alvium USB cameras: Sensor tilt](#) on page 246.

Housed Alvium Frame: Sensor shift and rotation

The following table defines the manufacturing accuracy for sensor positioning with housed Alvium Frame cameras. For sensor tilt, see [Housed Alvium USB cameras: Sensor tilt](#) on page 246.

Criteria	Subject	Properties
Alignment method		Optical alignment of the photosensitive sensor area into the camera front module (lens mount front flange)
Reference Points	Sensor	Center of the pixel area (photo sensitive cells)
	Camera	Center of the lens mount
Accuracy	x/y-axis	$\pm 90 \mu\text{m}$ (sensor shift)
	z	0 to $-50 \mu\text{m}$ (optical back focal length)
	α^1	$\pm 0.5 \text{ deg}$ (sensor rotation as the deviation from the parallel to the camera bottom)

Table 108: Alvium USB Frame cameras, sensor shift and rotation

Housed Alvium USB cameras: Sensor tilt

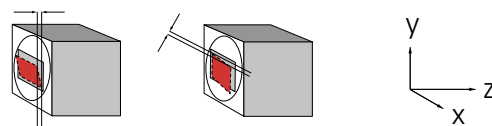

Gray rectangle: Reference sensor position **Red rectangle:** Current position

Figure 91: Sensor tilt

The following table defines sensor tilt as the variance between highest and lowest pixel of a sensor along the z-axis, measured in micrometers for housed Alvium USB cameras.

Alvium USB model	Pixel size	Maximum tilt
Alvium 1800 U-030 VSWIR	$5 \mu\text{m} \times 5 \mu\text{m}$	$50 \mu\text{m}$
Alvium 1800 U-040m/c	$6.9 \mu\text{m} \times 6.9 \mu\text{m}$	$95 \mu\text{m}$

Table 109: Sensor tilt (sheet 1 of 2)

Alvium USB model	Pixel size	Maximum tilt
Alvium 1800 U-050m/c	4.8 μm × 4.8 μm	47 μm
Alvium 1800 U-052m/c	9.0 μm × 9.0 μm	36 μm
Alvium 1800 U-120m/c	3.75 μm × 3.75 μm	29 μm
Alvium 1800 U-130 VSWIR	5 μm × 5 μm	50 μm
Alvium 1800 U-131m/c	5.3 μm × 5.3 μm	57 μm
Alvium 1800 U-158m/c	3.45 μm × 3.45 μm	24 μm
Alvium 1800 U-192m/c	4.5 μm × 4.5 μm	41 μm
Alvium 1800 U-203m/c	4.5 μm × 4.5 μm	41 μm
Alvium 1800 U-234m/c	5.86 μm × 5.86 μm	69 μm
Alvium 1800 U-235m/c	5.86 μm × 5.86 μm	69 μm
Alvium 1800 U-240m/c	3.45 μm × 3.45 μm	24 μm
Alvium 1800 U-291m/c	4.5 μm × 4.5 μm	18 μm
Alvium 1800 U-319m/c	3.45 μm × 3.45 μm	24 μm
Alvium 1800 U-320 VSWIR	3.45 μm × 3.45 μm	24 μm
Alvium 1800 U-500m/c	2.2 μm × 2.2 μm	15 μm
Alvium 1800 U-501m/c NIR	2.2 μm × 2.2 μm	15 μm
Alvium 1800 U-507m/c	3.45 μm × 3.45 μm	24 μm
Alvium 1800 U-507m/c Pol	3.45 μm × 3.45 μm	24 μm
Alvium 1800 U-508m/c	3.45 μm × 3.45 μm	24 μm
Alvium 1800 U-508m/c Pol	3.45 μm × 3.45 μm	24 μm
Alvium 1800 U-510m/c	2.74 μm × 2.74 μm	18 μm
Alvium 1800 U-511m/c	2.74 μm × 2.74 μm	18 μm
Alvium 1800 U-530 VSWIR	3.45 μm × 3.45 μm	24 μm
Alvium 1800 U-811m/c	2.74 μm × 2.74 μm	18 μm
Alvium 1800 U-812 UV	2.74 μm × 2.74 μm	15 μm
Alvium 1800 U-895m/c	3.45 μm × 3.45 μm	24 μm
Alvium 1800 U-1236m/c	3.45 μm × 3.45 μm	24 μm
Alvium 1800 U-1240m/c	1.85 μm × 1.85 μm	12 μm
Alvium 1800 U-1242m/c	2.74 μm × 2.74 μm	18 μm
Alvium 1800 U-1620m/c	2.74 μm × 2.74 μm	18 μm
Alvium 1800 U-2040m/c	2.74 μm × 2.74 μm	18 μm
Alvium 1800 U-2050m/c	2.4 μm × 2.4 μm	12 μm
Alvium 1800 U-2460m/c	2.74 μm × 2.74 μm	18 μm

Table 109: Sensor tilt (sheet 2 of 2)

User sets

Supported features

UserSet features enable to store individual settings on Alvium USB cameras. These user sets can be loaded by default, without needing to set values by software after every restart of the camera. Or they can be used to switch between different settings, for example, to adjust from daylight to artificial light.

User sets on Alvium USB cameras support all features except for:

- Command features
- Read-only features
- Features in the **LUTControl1** category#
- Selectors: Used to choose between various instances of a functionality.

Trigger features and UserSetDefault

Trigger features are reset to default values when the default user set is loaded.

- Column **UserSetLoad** displays how user values are affected when the command **UserSetLoad** is executed.
- Column **DeviceReset** displays how user values are affected when the command **DeviceReset** is executed.

Feature	Default value	UserSetDefault	DeviceReset
TriggerActivation	<i>RisingEdge</i>	Default value	Default value
TriggerMode	<i>Off</i>	Default value	Default value
TriggerSelector	<i>AcquisitionStart</i>	User value	Default value
TriggerSoftware	[Command]	Not applicable	Not applicable
TriggerSource	<i>Software</i>	Default value	Default value

Table 110: Trigger features being reset

Camera feature availability

Alvium 1800 U cameras support a number of standard and extended features. The following tables compare the availability of selected features by model.



Feature description and firmware downloads

Alvium Features Reference: www.alliedvision.com/en/support/technical-documentation/alvium-usb-documentation

Firmware downloads: www.alliedvision.com/en/support/firmware-downloads

Image control	Monochrome models	Color models	Supported models
Adaptive noise correction	✓	✓	All, except for: 1800 U-507 Pol, -508 Pol
Auto exposure	✓	✓	All
Auto gain	✓	✓	All
Auto white balance	-	✓	All, except for: 1800 U-507 Pol, -508 Pol
Color transformation (including hue, saturation)	-	✓	
Contrast	✓	✓	
Custom convolution	✓	✓	
De-Bayering up to 5x5	-	✓	
Digital binning	✓	✓	
DPC (defect pixel correction)	✓	✓	
FPNC (fixed pattern noise correction)	✓	✓	All, except for: 1800 U-030 VSWIR, -052, -130 VSWIR, -203, -234, -235, -291, -320 VSWIR, -507 Pol, -508 Pol, -530 VSWIR, -895, -2050
Gamma	✓	✓	All
Lens shading correction	✓	✓	All, except for: 1800 U-050
Look up table (LUT)	✓	✓	All, except for: 1800 U-507 Pol, -508 Pol

Table 111: Image control features by Alvium 1800 U model (sheet 1 of 2)

Image control	Monochrome models	Color models	Supported models
Multiple ROI (regions of interest)	✓	✓	All, except for: 1800 U-050, -120, -131, -192, -500, -501 NIR, -1240, -2050
Reverse X/Y	✓	✓	All
Sensor binning	✓	-	1800 U-158m, -203m, -240m, -291m, -500m, -501m NIR, -508m, -510m, -511m, -811m, -812 UV, -1242m, -1620m, -2040m, -2460m
Sharpness/Blur	✓	✓	All, except for: 1800 U-507 Pol, -508 Pol
Single ROI (region of interest)	✓	✓	All

Table 111: Image control features by Alvium 1800 U model (sheet 2 of 2)

Camera control	Monochrome models	Color models	Supported models
Acquisition frame rate	✓	✓	All
Bandwidth control (DeviceLinkThroughputLimit)	✓	✓	All
Counters and timers	✓	✓	All
Event channel	✓	✓	All, except for: 1800 U-050
Firmware update in the field	✓	✓	All
Image chunk data	✓	✓	All, except for: 1800 U-050
I/O and trigger control	✓	✓	All
Power saving mode	✓	✓	All
Sensor ADC readout modes (SensorBitDepth)	✓	✓	1800 U-030 VSWIR, -040, -052, -130 VSWIR, -158, -203, -234, -235, -240, -291, -320 VSWIR, -508, -508 Pol, -530 VSWIR

Table 112: Camera control features by Alvium 1800 U model (sheet 1 of 2)

Camera control	Monochrome models	Color models	Supported models
Sequencer	✓	✓	All, except for: 1800 U-050, -120, -131, -192, -500, -501 NIR, -1240, -2050
Serial I/Os	✓	✓	All
Temperature monitoring (mainboard)	✓	✓	All
Temperature monitoring (sensor) ¹	✓	✓	All, except for: 1800 U-050, -120, -131, -192, -234, -235, -1240, -2050
User sets	✓	✓	All

¹ The sensor temperature can be output only when the camera is not streaming.

Table 112: Camera control features by Alvium 1800 U model (sheet 2 of 2)

Lenses: Focal length vs. field of view

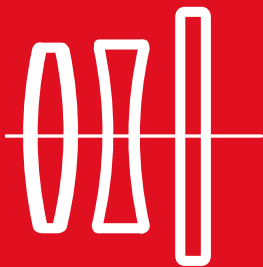

This chapter includes:

About this chapter	253
Optical vignetting with certain lenses	253
About S-Mount lenses	254
Focal length vs. field of view	254

About this chapter

This section presents tables that list selected fields of view (FOV) depending on sensor size, distance, and focal length of the lens.

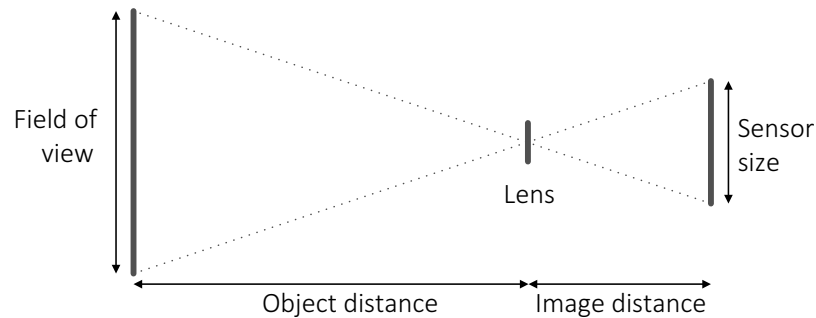

Figure 92: Parameters used in tables for focal length versus FOV



Allied Vision S-Mount lenses

For technical data of Allied Vision S-Mount lenses with dedicated operating instructions, see the S-Mount Lenses User Guide at

www.alliedvision.com/fileadmin/content/documents/products/accessories/lenses/Allied_Vision/Data_sheet/S-Mount-Lenses_User-Guide.pdf.

Parameters in tables

The distance to the object is measured from the first principal the plane of the lens to the object. For some lenses, manufacturers do not define the principal plane position. Production spread causes tolerances for all values, including actual focal lengths. Calculations apply for image reproduction without distortion. Therefore, values do not apply for fisheye lenses.

Please ask your Allied Vision Sales representative in case you need more information.

Optical vignetting with certain lenses

Lenses with short focal lengths may show optical vignetting at the edges of the image. Microlenses on the sensor pixels can increase the effect.

For demanding applications, we suggest testing camera and lens to find a suitable setup. If you have questions, please contact your Allied Vision Sales representative.

About S-Mount lenses

Alvium S-Mount models have no filter. For typical applications, we recommend using S-Mount lenses with an integrated IR cut filter for a better image quality.

Read [Mounting and focusing S-Mount lenses](#) on page 280 to avoid damage when using S-Mount lenses.

Focal length vs. field of view

Alvium 1800 U-030 VSWIR

Values for 1800 U-030 VSWIR cameras with Type 1/4 (4.1 mm diagonal) sensors:

Focal length [mm]	Field of view (H × V [mm])	
	Object distance = 500 mm	Object distance = 1000 mm
4	407 × 322	817 × 647
5	775 × 773	1557 × 1553
6	644 × 642	1296 × 1293
8	481 × 480	970 × 968
12	318 × 317	644 × 642
16	237 × 236	481 × 480
25	149 × 148	305 × 304
35	104 × 104	216 × 215
50	70 × 70	149 × 148

Table 113: Focal length versus field of view for Alvium 1800 U-030 VSWIR

Alvium 1800 U-040m/c

Values for 1800 U-040m/c cameras with Type 1/2.9 (6.3 mm diagonal) sensors:

Focal length [mm]	Field of view (H × V [mm])	
	Object distance = 500 mm	Object distance = 1000 mm
2.8	892 × 667	1789 × 1337
3.6	693 × 518	1390 × 1039
4.8	518 × 387	1041 × 778
6	414 × 309	832 × 622
8	309 × 231	623 × 465
12	204 × 153	414 × 309
16	152 × 114	309 × 231
25	95 × 71	196 × 146

Table 114: Focal length versus field of view for Alvium 1800 U-040m/c

Alvium 1800 U-050m/c

Values for 1800 U-050m/c cameras with Type 1/3.6 (4.9 mm diagonal) sensors:

Focal length [mm]	Field of view (H × V [mm])	
	Object distance = 500 mm	Object distance = 1000 mm
2.8	689 × 517	1381 × 1036
3.6	535 × 401	1073 × 805
4.8	400 × 300	804 × 603
6	319 × 239	643 × 482
8	239 × 179	481 × 361
12	158 × 118	319 × 239
16	117 × 88	239 × 179
25	74 × 55	151 × 113

Table 115: Focal length versus field of view for Alvium 1800 U-050m/c

Alvium 1800 U-052m/c

Values for 1800 U-052m/c cameras with Type 1/1.7 (9.2 mm diagonal) sensors:

Focal length [mm]	Field of view (H × V [mm])	
	Object distance = 500 mm	Object distance = 1000 mm
5	671 × 560	1348 × 1125
6	558 × 466	1122 × 937
8	417 × 348	840 × 701
12	275 × 230	558 × 466
16	205 × 171	417 × 348
25	129 × 107	264 × 221
35	90 × 75	187 × 156
50	61 × 51	129 × 107

Table 116: Focal length versus field of view for Alvium 1800 U-052m/c

Alvium 1800 U-120m/c

Values for 1800 U-120m/c cameras with Type 1/3 (6.0 mm diagonal) sensors:

Focal length [mm]	Field of view (H × V [mm])	
	Object distance = 500 mm	Object distance = 1000 mm
2.8	852 × 639	1709 × 1282
3.6	662 × 496	1329 × 996
4.8	495 × 371	995 × 746
6	395 × 296	795 × 596
8	295 × 221	595 × 446
12	195 × 146	395 × 296
16	145 × 109	295 × 221
25	91 × 68	187 × 140

Table 117: Focal length versus field of view for Alvium 1800 U-120m/c

Alvium 1800 U-130 VSWIR

Values for 1800 U-130 VSWIR cameras with Type 1/2 (8.2 mm diagonal) sensors:

Focal length [mm]	Field of view (H × V [mm])	
	Object distance = 500 mm	Object distance = 1000 mm
5	671 × 560	1348 × 1125
6	558 × 466	1122 × 937
8	417 × 348	840 × 701
12	275 × 230	558 × 466
16	205 × 171	417 × 348
25	129 × 107	264 × 221
35	90 × 75	187 × 156
50	61 × 51	129 × 107

Table 118: Focal length versus field of view for Alvium 1800 U-130 VSWIR

Alvium 1800 U-131m/c

Values for 1800 U-131m/c cameras with Type 1/1.8 (8.7 mm diagonal) sensors:

Focal length [mm]	Field of view (H × V in [mm])	
	Object distance = 500 mm	Object distance = 1000 mm
4.8	700 × 560	1407 × 1125
6	559 × 447	1124 × 899
8	417 × 334	841 × 673
12	276 × 221	559 × 447
16	205 × 164	417 × 334
25	129 × 103	265 × 212
35	90 × 72	187 × 150
50	61 × 49	129 × 103

Table 119: Focal length versus field of view for Alvium 1800 U-131m/c

Alvium 1800 U-158m/c

Values for 1800 U-158m/c cameras with Type 1/2.9 (6.3 mm diagonal) sensors:

Focal length [mm]	Field of view (H × V [mm])	
	Object distance = 500 mm	Object distance = 1000 mm
2.8	892 × 667	1789 × 1337
3.6	693 × 518	1390 × 1039
4.8	518 × 387	1041 × 778
6	414 × 309	832 × 622
8	309 × 231	623 × 465
12	204 × 153	414 × 309
16	152 × 114	309 × 231
25	95 × 71	196 × 146

Table 120: Focal length versus field of view for Alvium 1800 U-158m/c

Alvium 1800 U-192m/c

Values for 1800 U-192m/c cameras with Type 1/1.8 (9.0 mm diagonal) sensors:

Focal length [mm]	Field of view (H × V in [mm])	
	Object distance = 500 mm	Object distance = 1000 mm
4.8	743 × 557	1493 × 1120
6	593 × 445	1193 × 895
8	443 × 332	893 × 670
12	293 × 220	593 × 445
16	218 × 163	443 × 332
25	137 × 103	281 × 211
35	96 × 72	199 × 149
50	65 × 49	137 × 103

Table 121: Focal length versus field of view for Alvium 1800 U-192m/c

Alvium 1800 U-203m/c

Values for 1800 U-203m/c cameras with Type 1/1.7 (9.2 mm diagonal) sensors:

Focal length [mm]	Field of view (H × V [mm])	
	Object distance = 500 mm	Object distance = 1000 mm
5	727 × 556	1461 × 1118
6	605 × 462	1217 × 930
8	452 × 345	911 × 696
12	299 × 228	605 × 462
16	222 × 170	452 × 345
25	140 × 107	286 × 219
35	98 × 75	202 × 155
50	66 × 51	140 × 107

Table 122: Focal length versus field of view for Alvium 1800 U-203m/c

Alvium 1800 U-234m/c, 1800 U-235m/c

Values for 1800 U-234m/c and 1800 U-235m/c cameras with Type 1/1.2 (13.4 mm diagonal) sensors:

Focal length [mm]	Field of view (H × V in [mm])	
	Object distance = 500 mm	Object distance = 1000 mm
8	698 × 438 mm	1407 × 884 mm
12	461 × 290 mm	933 × 586 mm
16	343 × 215 mm	697 × 438 mm
25	215 × 135 mm	442 × 278 mm
35	150 × 94 mm	312 × 196 mm
50	102 × 64 mm	215 × 135 mm

Table 123: Focal length versus field of view for Alvium 1800 U-234m/c and 1800 U-235m/c

Alvium 1800 U-240m/c

Values for 1800 U-240m/c cameras with Type 1/2.3 (7.9 mm diagonal) sensors:

Focal length [mm]	Field of view (H × V in [mm])	
	Object distance = 500 mm	Object distance = 1000 mm
4.8	691 × 433	1389 × 871
6	552 × 346	1110 × 696
8	412 × 258	831 × 521
12	272 × 171	552 × 346
16	203 × 127	412 × 258
25	127 × 80	261 × 164
35	89 × 56	185 × 116
50	60 × 38	127 × 80

Table 124: Focal length versus field of view for Alvium 1800 U-240m/c

Alvium 1800 U-291m/c

Values for 1800 U-291m/c cameras with Type 2/3 (10.8 mm diagonal) sensors:

Focal length [mm]	Field of view (H × V in [mm])	
	Object distance = 500 mm	Object distance = 1000 mm
6	644 × 642	1296 × 1293
8	481 × 480	970 × 968
12	318 × 317	644 × 642
16	237 × 236	481 × 480
25	149 × 148	305 × 304
35	104 × 104	216 × 215
50	70 × 70	149 × 148

Table 125: Focal length versus field of view for Alvium 1800 U-291m/c

Alvium 1800 U-319m/c

Values for 1800 U-319m/c cameras with Type 1/1.8 (8.9 mm diagonal) sensors:

Focal length [mm]	Field of view (H × V in [mm])	
	Object distance = 500 mm	Object distance = 1000 mm
4.8	735 × 550	1476 × 1104
6	586 × 439	1180 × 882
8	438 × 328	883 × 661
12	290 × 217	586 × 439
16	215 × 161	438 × 328
25	135 × 101	278 × 208
35	95 × 71	196 × 147
50	64 × 48	135 × 101

Table 126: Focal length versus field of view for Alvium 1800 U-319m/c

Alvium 1800 U-320 VSWIR

Values for 1800 U-320VSWIR cameras with Type 1/1.8 (8.9 mm diagonal) sensors:

Focal length [mm]	Field of view (H × V in [mm])	
	Object distance = 500 mm	Object distance = 1000 mm
6	591 × 439	1189 × 882
8	441 × 328	890 × 661
12	292 × 217	591 × 439
16	217 × 161	441 × 328
25	136 × 101	280 × 208
35	95 × 71	198 × 147
50	65 × 48	136 × 101
75	41 × 30	89 × 66

Table 127: Focal length versus field of view for Alvium 1800 U-320 VSWIR

Alvium 1800 U-500m/c, 1800 U-501m/c NIR

Values for 1800 U-500m/c and 1800 U-501m/c NIR cameras with Type 1/2.5 (7.1 mm diagonal) sensors:

Focal length [mm]	Field of view (H × V in [mm])	
	Object distance = 500 mm	Object distance = 1000 mm
2.8	1013 × 759	2031 × 1523
3.6	786 × 590	1578 × 1184
4.8	588 × 441	1182 × 887
6	469 × 352	945 × 709
8	351 × 263	707 × 530
12	232 × 174	469 × 352
16	172 × 129	351 × 263
25	108 × 81	222 × 167

Table 128: Focal length versus field of view for Alvium 1800 U-500m/c, 1800 U-501m/c NIR

Alvium 1800 U-507m/c, 1800 U-507m/c Pol, 1800 U-508m/c, 1800 U-508m/c Pol

Values for 1800 U-507m/c, 1800 U-507m/c Pol, 1800 U-508m/c, and 1800 U-508m/c Pol cameras Type 2/3 (11.1 mm diagonal) sensors:

Focal length [mm]	Field of view (H × V in [mm])	
	Object distance = 500 mm	Object distance = 1000 mm
6	700 × 584	1408 × 1175
8	523 × 436	1054 × 880
12	346 × 288	700 × 584
16	257 × 215	523 × 436
25	162 × 135	332 × 277
35	113 × 94	234 × 196
50	77 × 64	162 × 135

Table 129: Focal length versus field of view for Alvium 1800 U-507m/c, 1800 U-507m/c Pol, 1800 U-508m/c, 1800 U-508m/c Pol

Alvium 1800 U-510m/c, 1800 U-511m/c

Values for 1800 U-510m/c and 1800 U-511m/c cameras with Type 1/1.8 (8.8 mm diagonal) sensors:

Focal length [mm]	Field of view (H × V in [mm])	
	Object distance = 500 mm	Object distance = 1000 mm
5	671 × 560	1348 × 1125
6	558 × 466	1122 × 937
8	417 × 348	840 × 701
12	275 × 230	558 × 466
16	205 × 171	417 × 348
25	129 × 107	264 × 221
35	90 × 75	187 × 156
50	61 × 51	129 × 107

Table 130: Focal length versus field of view for Alvium 1800 U-510 m/c, 1800 U-511m/c

Alvium 1800 U-530 VSWIR

Values for 1800 U-530 VSWIR cameras with Type 1/1.4 (11.4 mm diagonal) sensors:

Focal length [mm]	Field of view (H × V in [mm])	
	Object distance = 500 mm	Object distance = 1000 mm
6	736 × 584	1481 × 1175
8	550 × 436	1109 × 880
12	364 × 288	736 × 584
16	271 × 215	550 × 436
25	170 × 135	349 × 277
35	119 × 94	247 × 196
50	80 × 64	170 × 135
75	51 × 40	110 × 87

Table 131: Focal length versus field of view for Alvium 1800 U-530 VSWIR

Alvium 1800 U-811m/c, 1800 U-812 UV

Values for 1800 U-811m/c and 1800 U-812 UV cameras with Type 2/3 (11.0 mm diagonal) sensors:

Focal length [mm]	Field of view (H × V in [mm])	
	Object distance = 500 mm	Object distance = 1000 mm
5	773 × 773	1553 × 1553
6	642 × 642	1293 × 1293
8	480 × 480	968 × 968
12	317 × 317	642 × 642
16	236 × 236	480 × 480
25	148 × 148	304 × 304
35	104 × 104	215 × 215
50	70 × 70	148 × 148

Table 132: Focal length versus field of view for Alvium 1800 U-811m/c, 1800 U-812 UV

Alvium 1800 U-895m/c

Values for 1800 U-895m/c cameras with Type 1 (16.0 mm diagonal) sensors:

Focal length [mm]	Field of view (H × V in [mm])	
	Object distance = 500 mm	Object distance = 1000 mm
12	577 × 305	1168 × 618
16	429 × 227	873 × 462
25	270 × 143	553 × 293
35	189 × 100	391 × 286
50	128 × 68	270 × 143
100	57 × 30	128 × 68
135	38 × 20	91 × 48

Table 133: Focal length versus field of view for Alvium 1800 U-895m/c

Alvium 1800 U-1236m/c

Values for 1800 U-1236m/c cameras with Type 1.1 (17.6 mm diagonal) sensors:

Focal length [mm]	Field of view (H × V in [mm])	
	Object distance = 500 mm	Object distance = 1000 mm
8	872 × 638	1759 × 1287
12	577 × 422	1168 × 854
16	429 × 314	872 × 638
25	270 × 197	553 × 405
35	188 × 138	391 × 286
50	128 × 93	270 × 197
75	80 × 59	175 × 128

Table 134: Focal length versus field of view for Alvium 1800 U-1236m/c

Alvium 1800 U-1240m/c

Values for 1800 U-1240m/c cameras with Type 1/1.7 (9.33 mm diagonal) sensors:

Focal length [mm]	Field of view (H × V in [mm])	
	Object distance = 500 mm	Object distance = 1000 mm
4.8	763 × 578	1534 × 1161
6	609 × 461	1226 × 928
8	455 × 344	918 × 694
12	301 × 228	609 × 461
16	224 × 169	455 × 344
25	141 × 106	289 × 218
35	98 × 74	204 × 154
50	67 × 50	141 × 106

Table 135: Focal length versus field of view for Alvium 1800 U-1240m/c

Alvium 1800 U-1242m/c

Values for 1800 U-1242m/c cameras with Type 1/1.1 (14.0 mm diagonal) sensors:

Focal length [mm]	Field of view (H × V in [mm])	
	Object distance = 500 mm	Object distance = 1000 mm
6	931 × 679	1874 × 1365
8	696 × 507	1403 × 1022
12	460 × 335	931 × 679
16	342 × 249	696 × 507
25	215 × 157	441 × 321
35	150 × 109	312 × 227
50	102 × 74	215 × 157
75	64 × 47	139 × 102

Table 136: Focal length versus field of view for Alvium 1800 U-1242m/c

Alvium 1800 U-1620m/c

Values for 1800 U-1620m/c cameras with Type 1.1 (16.8mm diagonal) sensors:

Focal length [mm]	Field of view (H × V in [mm])	
	Object distance = 500 mm	Object distance = 1000 mm
5	1445 × 825	2905 × 1658
6	1202 × 686	2419 × 1380
8	898 × 512	1810 × 1033
12	594 × 339	1202 × 686
16	442 × 252	898 × 512
25	277 × 158	569 × 325
35	194 × 111	403 × 230
50	131 × 75	277 × 158
75	83 × 47	180 × 103

Table 137: Focal length versus field of view for Alvium 1800 U-1620m/c

Alvium 1800 U-2040m/c

Values for 1800 U-2040m/c cameras with Type 1.1 (17.5 mm diagonal) sensors:

Focal length [mm]	Field of view (H × V in [mm])	
	Object distance = 500 mm	Object distance = 1000 mm
6	1018 × 1018	2048 × 2048
8	760 × 760	1533 × 1533
12	503 × 503	1018 × 1018
16	374 × 374	760 × 760
25	235 × 235	482 × 482
35	164 × 164	341 × 341
50	111 × 111	235 × 235
75	70 × 70	152 × 152
85	60 × 60	133 × 133

Table 138: Focal length versus field of view for Alvium 1800 U-2040m/c

Alvium 1800 U-2050m/c

Values for 1800 U-2050m/c cameras with Type 1 (15.9 mm diagonal) sensors:

Focal length [mm]	Field of view (H × V in [mm])	
	Object distance = 500 mm	Object distance = 1000 mm
8	811 × 542	1636 × 1093
12	536 × 358	1086 × 726
16	399 × 267	811 × 542
25	251 × 167	514 × 344
35	175 × 117	364 × 243
50	119 × 79	251 × 167
75	75 × 50	163 × 109
85	64 × 43	142 × 95
100	53 × 35	119 × 79

Table 139: Focal length versus field of view for Alvium 1800 U-2050m/c

Alvium 1800 U-2460m/c

Values for 1800 U-2460m/c cameras with Type 1.2 (19.3 mm diagonal) sensors:

Focal length [mm]	Field of view (H × V in [mm])	
	Object distance = 500 mm	Object distance = 1000 mm
8	898 × 776	1810 × 1566
12	594 × 513	1202 × 1040
16	442 × 382	898 × 776
25	277 × 240	569 × 492
35	194 × 168	403 × 348
50	131 × 114	277 × 240
75	83 × 72	180 × 156

Table 140: Focal length versus field of view for Alvium 1800 U-2460m/c

Installing the camera



This chapter includes:

Touching hot cameras	270
Sensor damage by ESD.....	270
Bare board cameras	270
Mounting the heat sink.....	272
Mounting the camera	273
Mounting the lens.....	279
Software and driver installation on the host	283

Touching hot cameras



CAUTION

Risk of burns

A camera in operation can reach temperature levels which could cause burns.

- Wear protective gloves when you touch a camera that is heated up.
- Ensure proper cooling of the camera.

Sensor damage by ESD



NOTICE

Possible damage to the sensor

In Alvium USB cameras without a closed housing, sensors can be damaged by ESD. In the output image, this may become visible as bubbles or blobs, for example. For details, see the note in [Possible damage to image sensors due to electrostatic discharge](#) on page 69.

- Provide ESD protection measures in accordance with technical standards.
- Follow the instructions in [ESD](#) on page 65.

Bare board cameras

If you intend to design an application using bare board cameras, please consider:

- Alvium bare board cameras are not aligned. You must align these cameras into housings individually, which is extremely difficult and expensive. As a possible solution, Alvium Frame cameras provide alignment areas and holes to fit into individual housings, see [Alvium Frame- use your own optical mount](#) on page 19.
- Aligning the sensor to the lens is extremely difficult and expensive. Therefore, we recommend you to do evaluation with housed cameras first.
- Bare board cameras are specialized components. We cannot give all data needed for any application in advance.
- Please let us partner with you for bare board camera applications to ensure a successful design.

Serial numbers of Alvium® chips and bare board cameras

Bare board cameras do not have enough space for a label with all the required information. Therefore, they are shipped with a 25 mm × 25 mm sandwich label on the blister pack. In [Figure 93](#), this label shows, for example:

- Product code: 14767 for a 1800 U-240c Bare Board 90 °Camera
- Alvium® chip SN (serial number): 183603543
- Camera SN (serial number): R7QW5 as digits and 2D code.

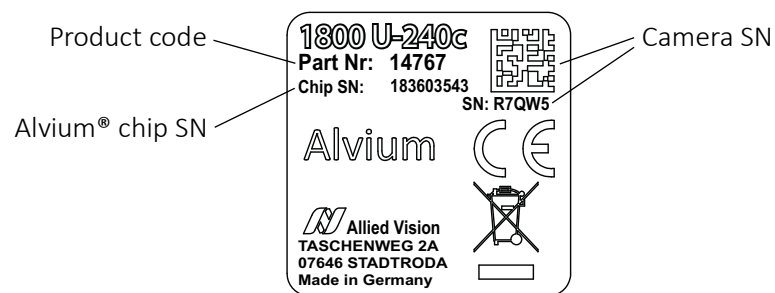

Figure 93: Sandwich label on blister packs shipped for bare board cameras

Before operating the camera, we recommend you to pull the sandwich label off the blister pack and stick it close to the camera.

If the label is lost, please read out with your smart phone the serial number of the Alvium® chip from the 2D code (a) shown in [Figure 94](#). With this number, we can look up the serial number of the camera in our database.

If your smart phone cannot read the 2D code: In [Figure 94](#), for example, the serial number (b) is 20450991.

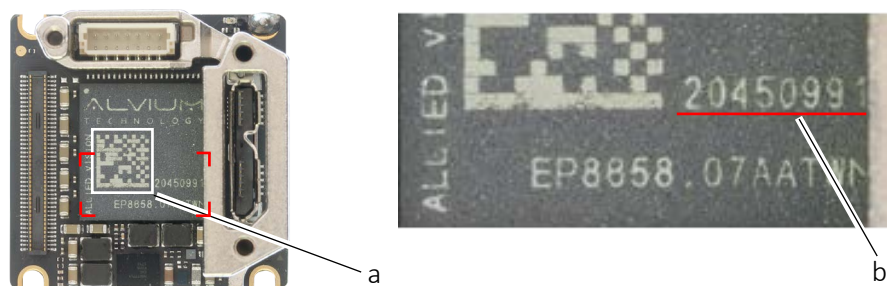

Figure 94: Alvium® chip imprint with detail view (right)

Mounting the heat sink

Keep the operating temperature in the specified range to enable best image quality and to protect the camera from damage. We recommend you to equip Alvium bare board and open housing cameras with heat sinks.



Optimizing heat dissipation

For details, see the Optimum Heat Dissipation for Housed Alvium Cameras application note at www.alliedvision.com/en/support/technical-documentation/alvium-usb-documentation.



NOTICE

Damage to the camera by heat sinks mounted improperly

- Allow mechanical contact only at the cooling area.
- Avoid any mechanical stress to the sensor and electronics area.
- Avoid short circuits of the electronics components.



NOTICE

Damage to the sensor, filter, and lens by corrosive substances

Some conductive media for heat sinks contain corrosive substances that can damage optical surfaces of the sensor, filter, and lens.

- Cover the optical path of the camera when you apply heat sink compound or adhesive to prevent substances and fumes from damaging optical surfaces.
- Adhere to the instructions and safety notes provided by the manufacturer of the conductive media.



NOTICE

Damage to camera electronics

Heat sinks can cause short circuits if they are not electrically isolated.

Avoid electrical contact between electronic components by unsuitable heat sinks and thermal conductive media.

Connect components in the cooling area (blue area in [Figure 95](#)) to a heat sink, following the instructions of the manufacturer of the heat sink and the thermal conductive media. Cooling area for Alvium USB 90° models are the same as for standard models.

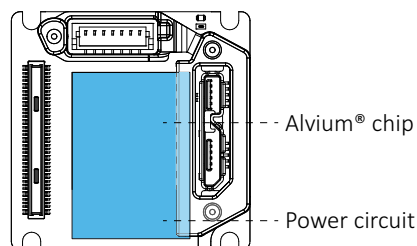

Figure 95: Cooling area for Alvium USB bare board cameras



Heat sink compound

Because electronic parts vary in height, we have updated our recommendation:

- Use flexible heat sink compound to compensate for potential gaps between the electronic parts to be cooled and heat sinks.
- Consider 1 mm to cover for worst case scenarios.
- For details, see the Alvium STEP files at www.alliedvision.com/en/support/alvium-step-file-downloads.

Mounting the camera



CAUTION

Injury by falling cameras or lenses

A falling camera or lens can cause injury.

- Ensure proper mounting of cameras and lenses, especially for dynamic applications.
- Mount cameras as described in the instructions.
- Always make sure the mounting threads are intact.
- Fasten screws with maximum torque, using the entire thread engagement. For less thread engagement, see [Adapting maximum torque values](#) on page 279.
- We recommend you to apply thread locking.
- Use a lens support for heavy lenses.

Mounting bare board cameras



Heat dissipation and electromagnetic compatibility for bare board cameras

For heat dissipation, see the Optimum Heat Dissipation for Alvium Cameras application note.

For initial guidance on electromagnetic compatibility, see the Electromagnetic Compatibility for Open Housing Alvium Cameras application note.

See www.alliedvision.com/en/support/technical-documentation/alvium-usb-documentation.

NOTICE
Damage to the camera by improper mounting

- Allow mechanical contact only at the mounting area.
- Avoid any mechanical stress to the sensor and the electronics area.
- Avoid short circuits of the electronics components.
- Give 2 mm minimum clearance above board components.
- Tighten screws at 0.1 Nm maximum torque.

Sensor alignment for bare board cameras

The sensors in Alviium bare board cameras are not aligned to a lens mount. You must align these cameras into housings individually, which can be difficult and expensive. As a possible solution, Alviium Frame cameras provide alignment areas and holes to fit into individual housings, see [Alviium Frame- use your own optical mount](#) on page 19.

Schematic drawings in [Figure 96](#) show Alviium USB bare board cameras. Only the mounting area (gray) can be used for mounting. The sensor and electronics area (red) must not be touched nor put at mechanical stress.

a = Mounting hole | b = Mounting hole and chassis ground

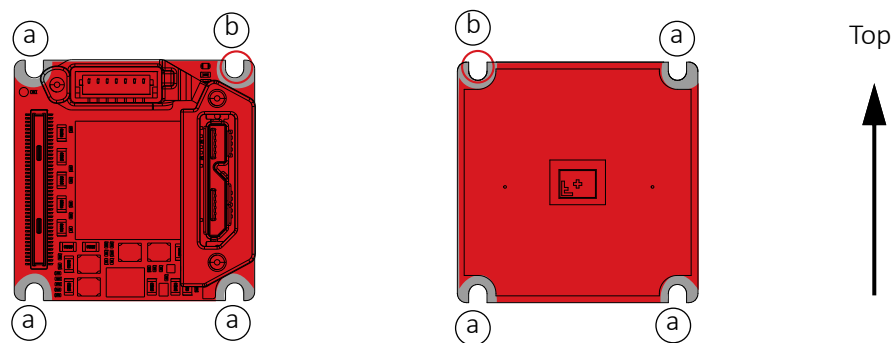

Figure 96: Mounting area of Alviium USB bare board cameras connector side (left); sensor side (right)

Mount the bare board with four M1.6 screws at 0.1 Nm maximum torque. Mounting areas for Alviium USB 90° models are the same as for standard models.

Mounting housed standard cameras

Bottom or top mounting

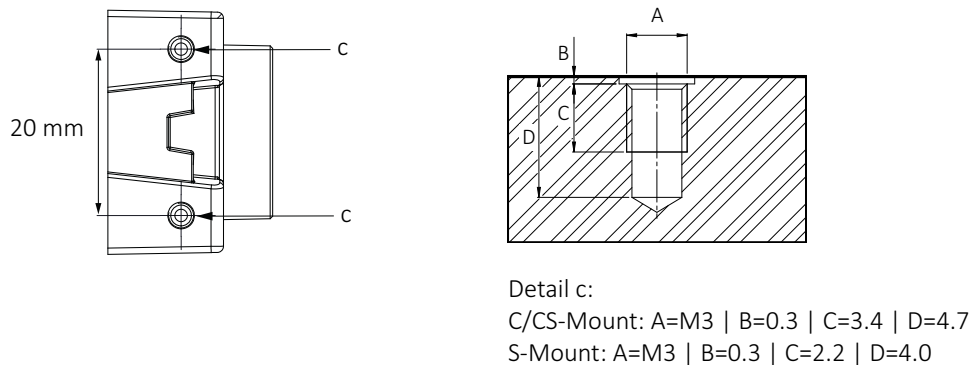

Figure 97: Top and bottom and mounting threads (c)

The maximum torque value applies only if the entire thread engagement is used. For other values, see [Adapting maximum torque values](#) on page 279.

1. Mount the camera to the base using suitable M3 screws,
 - a. **C-Mount, CS-Mount:** At 0.79 Nm maximum torque for a thread engagement (C) of 3.4 mm between screws and mounting threads.
 - b. **S-Mount:** At 0.51 Nm maximum torque for a thread engagement (C) of 2.2 mm between screws and mounting threads.

See Figure 97. For technical drawings, see [Standard Alvium: Technical drawings](#) on page 220 and [Alvium Flex: Technical drawings](#) on page 236.

2. Continue with [Mounting the lens](#) on page 279.

Front mounting

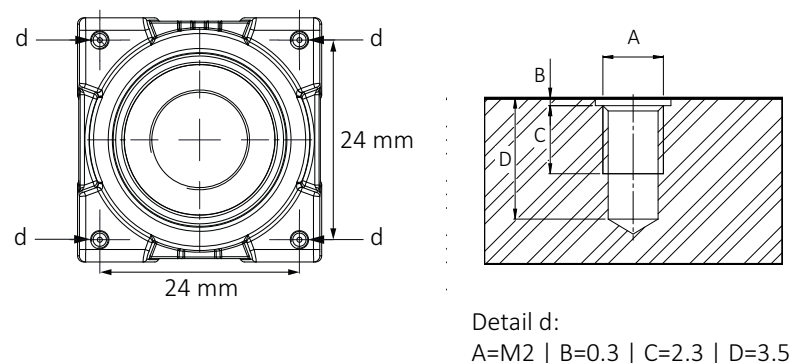

Figure 98: Camera front with mounting threads (d)

The maximum torque value applies only if the entire thread engagement is used. For other values, see [Adapting maximum torque values](#) on page 279.

1. Mount the camera to the base using suitable M2 screws at 0.23 Nm maximum torque for a thread engagement (C) of 2.3 mm between screws and mounting threads.

See [Figure 98](#). For technical drawings, see [Standard Alvium: Technical drawings](#) on page 220 and [Alvium Flex: Technical drawings](#) on page 236.

We recommend you to additionally use bottom and top mounting threads for a more solid connection.

2. Continue with [Mounting the lens](#) on page 279.

Installing Alvium Frame cameras



CAUTION

Risk of cuts by sharp edges of the circular front opening

- Avoid touching these edges with your fingers.
- Wear protective gloves for handling Alvium Frame cameras with an open circular front opening.



NOTICE

Damage to the sensor

The sensor can be damaged if the sensor surface is exposed to dirt or mechanical stress.

- Ensure that lenses or objects, such as optical elements do not exceed the specified maximum protrusion.
- Keep your fingers and tools outside the area inside the frame flange.
- Provide the following conditions to keep dirt and droplets out of the optical system of camera:
 - Dust-free environment
 - Low relative humidity
 - No condensation.

Aligning the sensor with your optical system

Alvium Frame cameras are manufactured so that the sensor is aligned with your optical system with optimal precision. You can select between alignment methods:

- A:** Using the lateral alignment areas (1) and the front alignment area (2).

B: Using the front area (2) and the two alignment holes (3).

A Alignment by using the lateral alignment areas (1) and the front area (2)

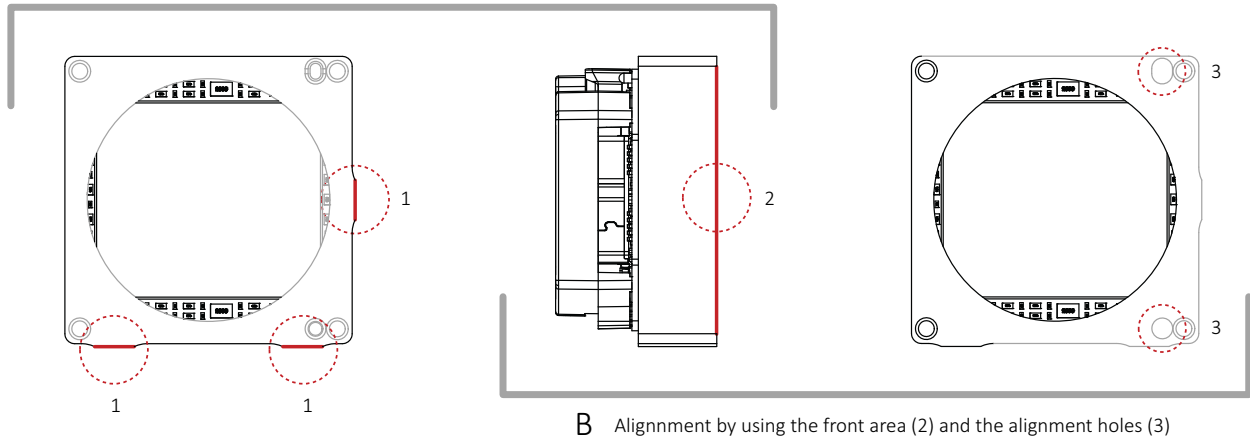

B Alignment by using the front area (2) and the alignment holes (3)

Figure 99: Alignment methods



Dimensions and accuracy

For the dimensions and accuracy of the alignment areas and the alignment holes, see [Alvim Flex: Technical drawings](#) on page 236.

For the accuracy of the sensor position, see [Housed standard and Flex cameras: Sensor shift and rotation](#) on page 245 and [Housed Alvim USB cameras: Sensor tilt](#) on page 246.

When you design Alvim Frame cameras into your system, observe values for:

- Flange focal distance, optical: 3.576 mm
- Maximum protrusion of 1.5 mm into the frame measured from the front area (2).

Mounting Alvium Frame

Especially for dynamic applications with high acceleration, mount the camera using all 4 mounting threads.

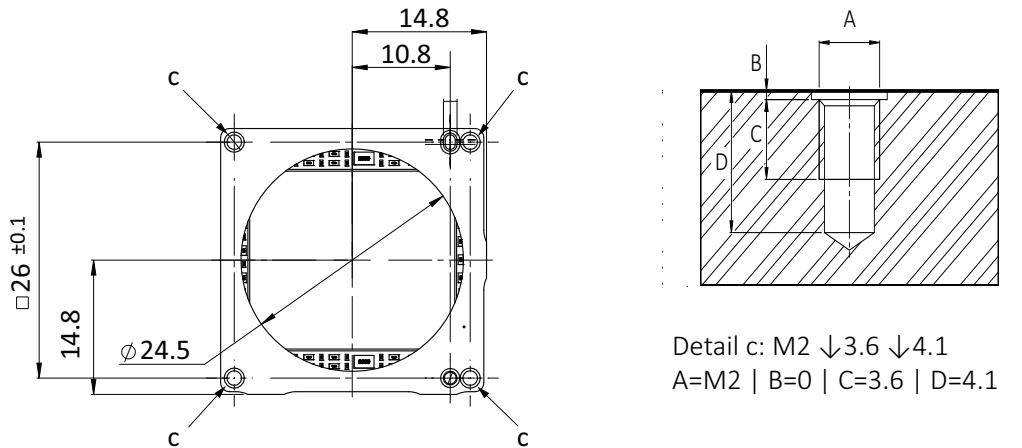

Figure 100: Mounting threads Alvium Frame

The maximum torque value applies only if the entire thread engagement is used. For other values, see [Adapting maximum torque values](#). For technical drawings, with further values and tolerances, and references for alignment, see [Alvium Frame: Technical drawings](#) on page 240.

As shown in [Figure 100](#), mount the camera to the base using suitable M2 screws for the 4 mounting threads: At 0.4 Nm maximum torque for a thread engagement (C) of 3.6 mm between screws and mounting threads.

Adapting maximum torque values

This is a general example. Use the corresponding values for your camera. The total screw length composes of the mounting holes length and the height of your mounting base. For using less than the recommended length of thread engagement, calculate maximum torque as follows:

$$\frac{\text{Current length of thread engagement}}{\text{Length of thread engagement in table}} \times \text{Torque in table} = \text{Current torque}$$

Example for a length of thread engagement of **2.0 mm** instead of 2.3 mm:

$$\mathbf{2.0\ mm} / 2.3\ \text{mm} \times 0.23\ \text{Nm} = \mathbf{0.20\ Nm}$$

Thread group	Thread position	Thread type	Total protrusion	Length of thread engagement	Maximum torque
d	Front mounting	M2	2.6 mm	2.3 mm	0.23 Nm
d	Front mounting	M2	2.6 mm	2.0 mm	0.20 Nm

Table 141: Adjusting maximum torque values

To ensure that the screws do not become loose over time, we recommend you to use means for securing screws, such as screw locking varnish.



Tripod adapter

For more information, see www.alliedvision.com/en/products/accessories.

Mounting the lens

Observe the following notes before you mount lenses to Alviium USB cameras.



CAUTION

Injury by falling cameras or lenses

A falling camera or lens can cause injury.

- Ensure proper mounting of cameras and lenses, especially for dynamic applications.
- Mount cameras as described in the instructions.
- Use a lens support for heavy lenses.

CAUTION
Risk of cuts by sharp edges of lens mounts

The threads of the lens mount can have sharp edges.
Be careful when mounting or unmounting lenses.

NOTICE
Damage to sensor, optics, or electronics by unsuitable lenses

The sensor, filter, lens, or electronics can be damaged if a lens exceeding maximum protrusion is mounted to the camera.

- Use lenses only up to the specified maximum protrusion, see [Maximum protrusion for front mounts](#) on page 243.
- S-Mount lenses must be screwed into the camera at less than max. protrusion (11.0 mm), see [Mounting and focusing S-Mount lenses](#) on page 280.
- Avoid short S-Mount lenses falling into the camera.

Mounting and focusing S-Mount lenses

Allied Vision S-Mount lenses

For technical data of Allied Vision S-Mount lenses with dedicated operating instructions, see the S-Mount Lenses User Guide at www.alliedvision.com/fileadmin/content/documents/products/accessories/lenses/Allied_Vision/Data_sheet/S-Mount-Lenses_User-Guide.pdf.

This section instructs how to use S-Mount lenses with your camera safely. S-Mount lenses are screwed into the mount to adjust focus. Vibration moves lenses out of position. Several techniques can be used to fasten S-Mount lenses in focus. We recommend using fixing nuts. See instructions in this section.

Drawings and fixing nuts

- Drawings in the instructions are schematic.
- Several manufacturers offer various types of S-Mount fixing nuts. The type shown in the instructions drawings is an example.
- We recommend using pinch nose pliers to tighten fixing nuts.

[Figure 101](#) shows how fixing nuts lock S-Mount lenses.
Follow the instructions to lock the lens in focus position.

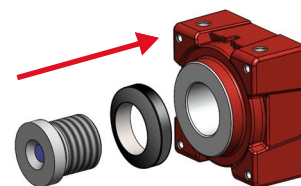

Figure 101: Fixing nut locking an S-Mount lens

NOTICE
Damage to sensor, optics, or electronics by improper handling

If an S-Mount lens is screwed against the sensor or electronics, sensor, lens, or electronics can be damaged.

- Screw in the lens at less than 11.0 mm maximum protrusion.
- Follow the instructions carefully.

Determining the allowed range for the position of the lens

1. Measure the length of the lens.
2. Calculate: $a = c - b$
 a: length of the mounted lens, measured from lens mount front flange
 b: maximum protrusion (11.0 mm)
 c: length of the lens

See [Maximum protrusion for front mounts](#) on page 243.

3. Set a gauge to the length of (a).

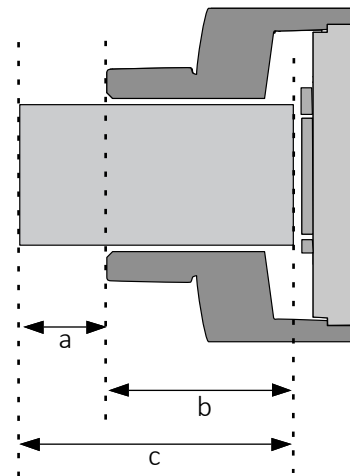

Figure 102: S-Mount lens and maximum protrusion

Mounting the fixing nut to the lens

4. Screw the fixing nut clockwise onto the lens until you can hold the front part (d) of the lens with your finger tips.



Figure 103: Lens and fixing nut

Focusing the lens

5. **Checking (a) with a gauge**, slowly screw the lens clockwise into the lens mount until the image is roughly in focus.
6. Slowly screw in and unscrew the lens until you have found the most accurate focus.

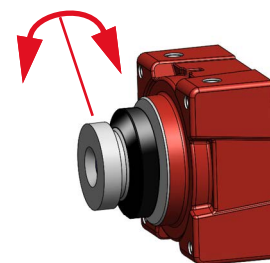

Figure 104: Adjusting focus

**NOTICE****Damage to lens threads and fixing nut by excessive force**

If the fixing nut is screwed with too much force, threads are worn out and the lens cannot be locked anymore.

Screw fixing nuts hand tight to keep the lens in a fixed position.

Locking focus

Pinch nose pliers are used to screw the fixing nut:

7. Holding the lens in position with one hand, screw the fixing nut clockwise against the lens mount until you feel the lens is locked.

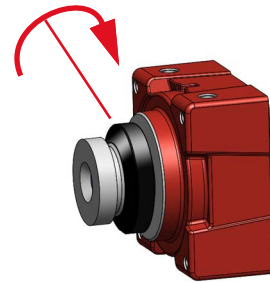

Figure 105: Tightening the fixing nut

Checking focus is set and locked properly

8. Check No.1: Try to rotate the lens with little force in both directions to ensure the lens is safely locked in position.

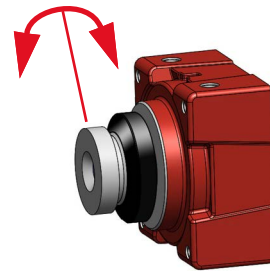

Figure 106: Checking lens is safely locked

9. Check No. 2: S-Mount thread allows a slightly tilted lens position. In this case, focus for a common object plane varies over the image plane.

If focus is constant over the image plane, you are done.

If focus varies over the image plane, the lens is tilted. Continue with 10.

10. Loosen the fixing nut.
11. Continue with 6.

The lens is locked in focus and ready for operation.

Software and driver installation on the host



Easy camera access with Vimba X

This section lists general requirements to operate Alvium USB cameras on your system.

To download **Vimba X SDK** for Windows, Linux, Linux/ARM, and macOS, including **Vimba X Viewer**, **Firmware Updater**, and **Driver Installer** for Windows, see www.alliedvision.com/en/products/software/vimba-x-sdk.

For more details see **ReleaseNotes_Linux.txt** or **ReleaseNotes_Windows.txt** in the directory of your **Vimba X** installation, or see www.alliedvision.com/en/products/software/vimba-x-sdk.

Required components



Driver installation and OS support

Windows: Please use **Vimba X** to install the camera driver. For **Vimba X** system requirements and supported Windows versions, see www.alliedvision.com/en/products/software/vimba-x-sdk.

Linux: Allied Vision does not provide a special driver. For **Vimba X** system requirements and supported operating systems, see www.alliedvision.com/en/products/software/vimba-x-sdk.

You need the following accessories:

- USB 3.0 or 3.1 Gen 1 external host controller card or on-board host controller
- USB 3.0 or 3.1 Type-A to Micro-B cable.



Compatible USB 3.0 or 3.1 Gen 1 accessories

See www.alliedvision.com/en/products/accessories.

Connecting the camera to the host

Connecting USB cables

Providing sufficient **strain relief** to avoid camera damage:

Plug the Micro USB 3.0 connector of the USB cable to the camera and fasten the locking screws. Connect the other USB connector to the host.



Compatible USB 3.0 cables

For USB 3.0 interface cables, industrial grade, with screw locks, Standard-A to Micro-B, see www.alliedvision.com/en/products/accessories.

Installing the camera driver using Vimba X on a Windows system

Instructions in this chapter describe installation of the camera driver using **Vimba X** on a Windows system. On Linux systems, the generic driver for USB3 Vision devices is used.



Unexpected events

Should installation or operation not work properly, see [Performance and troubleshooting](#) on page 313.

Using the camera with third-party drivers

Alvium USB cameras may not support third-party drivers. We recommend using the **Vimba X** camera driver.

Installing drivers for camera and host adapter

Installing the host adapter and Vimba X

1. Install the USB 3.0 or 3.1 Gen 1 host controller card and driver according to the manufacturer's instructions.
2. Download and install **Vimba X**: www.alliedvision.com/en/products/software/vimba-x-sdk
3. Continue with [Installing the camera driver](#).

Installing the camera driver



Connecting the camera to a USB 2.0 port

If the Alviium USB camera is connected to a USB 2.0 port, the **Vimba X** driver can be installed and the camera can be configured and operated. But for full performance, the camera must be connected to a USB 3.0 or 3.1 Gen 1 port.



Command line driver installer

Vimba X also provides a command line driver installer. For more information about the **Vimba X Driver Installer**, see the manual, included in the **Vimba X** download.

During the **Vimba X** installation, select at least **camera demonstration** and **Vimba X applications** to operate Alviium USB cameras. If the camera is not recognized or to subsequently change an assigned driver, follow the instructions:

1. Connect your Alviium USB camera to the computer using a USB 3.0 or 3.1 Type-A to Micro-B cable.
2. Start **Vimba X Driver Installer** and open the **USB3 Vision Cameras** tab. The **Driver Source** is not installed, yet. If other USB3 Vision devices are installed, another USB3 Vision driver may be assigned to your camera.
3. Click the Alviium USB camera entry. The current **Vimba X** driver is offered as a popup (Vimba 3.0.0 in the example).
4. Open **Install driver > USB3 Vision Camera** and click the driver popup.

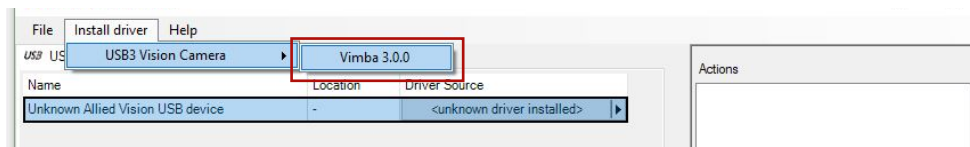

Figure 107: Vimba X Driver Installer, camera driver not installed

5. Click **Apply** to install the **Vimba X** driver for the camera.

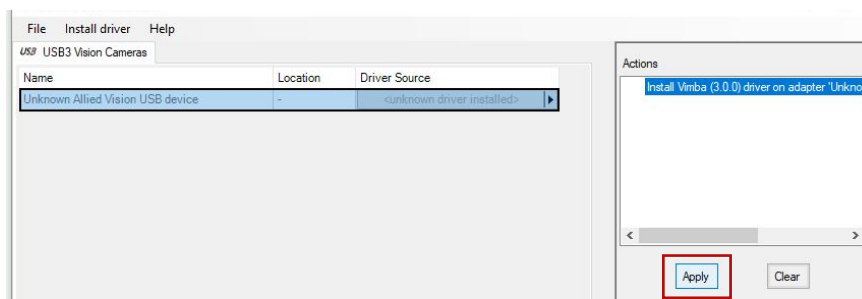

Figure 108: Vimba X Driver Installer, driver installation started

The driver has been installed successfully, the camera is recognized.

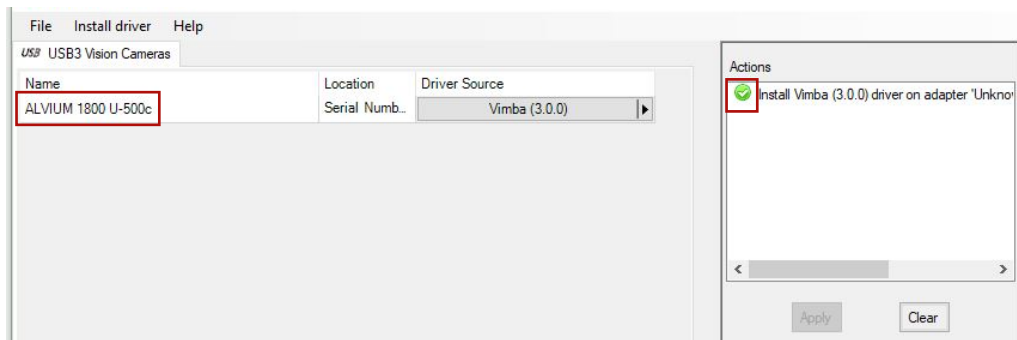

Figure 109: Vimba X Driver Installer, driver installed successfully



Manual Vimba X driver installation

Windows: For manual **Vimba X** driver installation, see the following instructions.

Installing the camera driver with Windows tools

As an alternative practice, you can install the **Vimba X** driver manually. Check for connected USB devices on your Windows system.



Screenshots are examples

The following screenshots were taken on a test system. The view may be different, depending on the configuration of your system.

Under Windows, the **Device Manager** provides an overview of USB resources and connected devices. As long as the **Vimba X** USB device driver is not installed, the camera is not recognized.

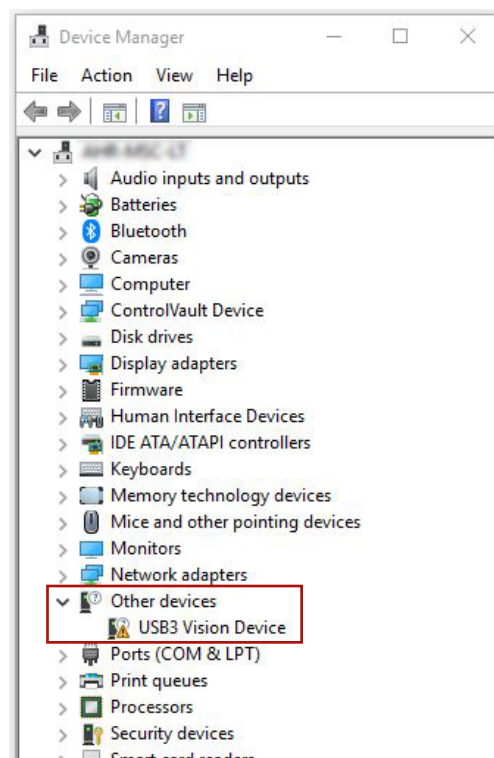

Figure 110: Windows Device Manager, unrecognized USB3 Vision camera

If no **USB3 Vision Device** is shown under the section **Other devices**, continue with action step 1. Otherwise, continue with action step 3.

1. Look at the section **Universal Serial Bus controllers**.
2. Disable the new found **USB Composite Device** and enable it again.
This creates the entry under the section **Other Devices** as shown in [Figure 110](#).

- Right-click the unrecognized **USB3 Vision Device** and select *Update driver*.

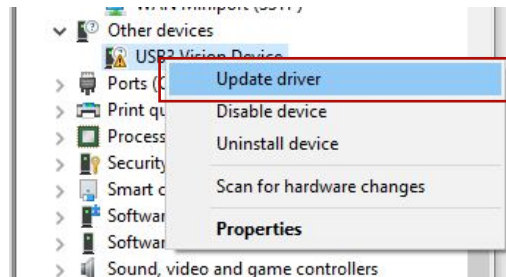

Figure 111: Windows Device Manager, Windows Driver Installer

- Click: “Browse my computer for driver software”.
 - Select [Your local Vimba X directory]\Allied Vision\Vimba X\Driver.
 - Follow the instructions.
- The camera driver is installed successfully.

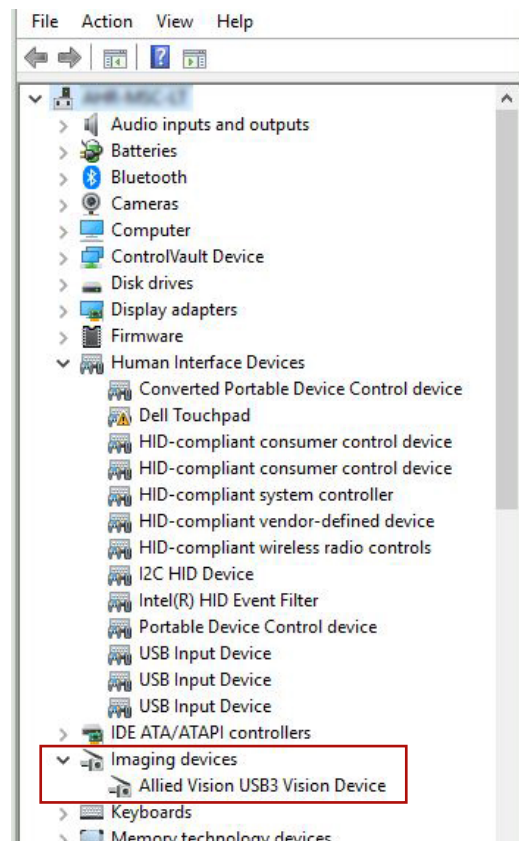
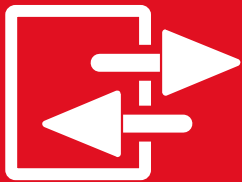

Figure 112: Windows Device Manager, USB3 Vision camera installed successfully

Camera interfaces



This chapter includes:

Standard Alvium and Alvium Frame: Connections	290
Alvium Flex: Connections.....	293
All Alvium USB: Connections.....	297

Standard Alvium and Alvium Frame: Connections

Recommended accessories



Compatible electronics accessories

See www.alliedvision.com/en/products/accessories.

Back panel

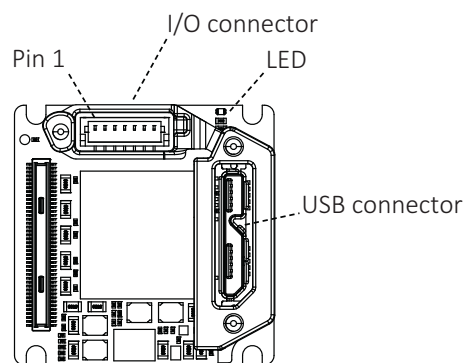

Figure 113: Bare board camera

Interface descriptions

Interface	Section in this user guide
I/O connector	Non-isolated, programmable GPIOs on page 298
Status LED	Status LED on page 300

Table 142: Interface descriptions overview

For I/O connector pin assignment, see [I/O connector pin assignment](#) on page 291.

I/O connector pin assignment



I/O connector details

JST BM07B-SRSS-TBT connector set consists of:

- Camera connector: JST BM07B-SRSS-TBT
- Cable housing: JST SHR-07V-S
- Cable, crimp contacts: JST SSH-003T-P0.2-H

See www.jst.de for details.



I/O cables and electromagnetic interference (EMI)

Consider for I/O cables by Allied Vision:

- 12319 JST I/O cables without screw lock have no shielding and are designed to be used with bare board or open housing Alvium cameras.
- For applications without an additional EMC housing, use shielded cables, such as 12322 JST I/O cables **with screw lock**.



NOTICE

Damage by reverse polarity

If Alvium USB cameras are externally powered with reverse polarity, the cameras can be damaged.

Power Alvium USB cameras according to the specifications described in this section.



NOTICE

Damage by serial communication voltage levels

If you are using serial communication (UART, similar to RS232), keep voltage levels in the range defined in [Table 143](#) on page 292. Typical RS232 voltage levels (such as ± 10 VDC) are not supported without external circuitry.

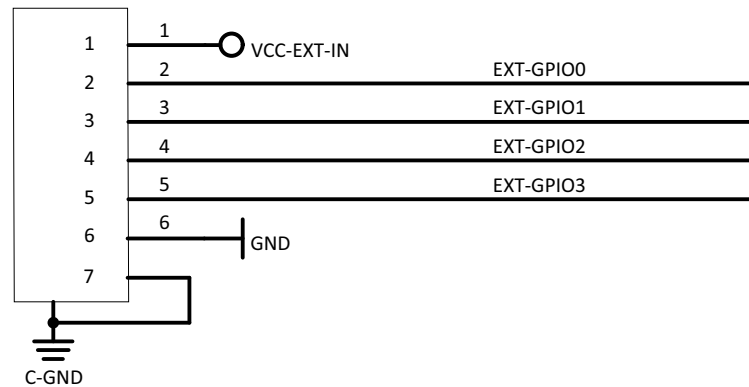

Figure 114: Pin assignment of JST BM07B-SRSS-TBT type I/O connector

Pin	Signal	Direction	Level	Description
1	VCC-EXT-IN	PWR IN	5 VDC ($\pm 10\%$) See Power supply voltage for I/O cables on page 297.	Power supply voltage See Camera power on page 66.
2	EXT-GPIO0	IN/OUT	$U_{in} \text{ (low)} = -0.3 \text{ to } 0.8 \text{ VDC}$ $U_{in} \text{ (high)} = 2.0 \text{ to } 5.5 \text{ VDC}$ $U_{out} \text{ (low)} = 0 \text{ to } 0.4 \text{ VDC}$ $U_{out} \text{ (high)} = 2.4 \text{ to } 3.3 \text{ VDC at max. } 12 \text{ mA}$	GPIO: Line0 Internal pull-up resistor: 33 k Ω to 63 k Ω
3	EXT-GPIO1	IN/OUT	See Pin 2, EXT-GPIO0	GPIO: Line1 Internal pull-up resistor: 33 k Ω to 63 k Ω
4	EXT-GPIO2	IN/OUT	See Pin 2, EXT-GPIO0	GPIO: Line2 Internal pull-up resistor: 33 k Ω to 63 k Ω
5	EXT-GPIO3	IN/OUT	See Pin 2, EXT-GPIO0	GPIO: Line3 Internal pull-up resistor: 33 k Ω to 63 k Ω
6	GND	—	0 VDC	Power supply ground
7	C-GND	—	0 VDC	Chassis ground and shielding

Table 143: Pin assignment of the JST BM07B-SRSS-TBT type I/O connector

Alvium Flex: Connections

Observe for DF40C-50DP-0.4V connectors

Because using the Hirose DF40C-50DP-0.4V connector on Alvium Flex cameras is a novelty, no standard can be applied for the pinning. Therefore, connect your individual electronic parts only if you are an electronics expert. Otherwise, we recommend you to use boards and cables offered by Allied Vision for testing and evaluation, but also for final applications.



Alvium Flex accessories

See the Alvium Flex Design and Accessory Guide at www.alliedvision.com/en/support/technical-documentation/alvium-usb-documentation.

Back panel

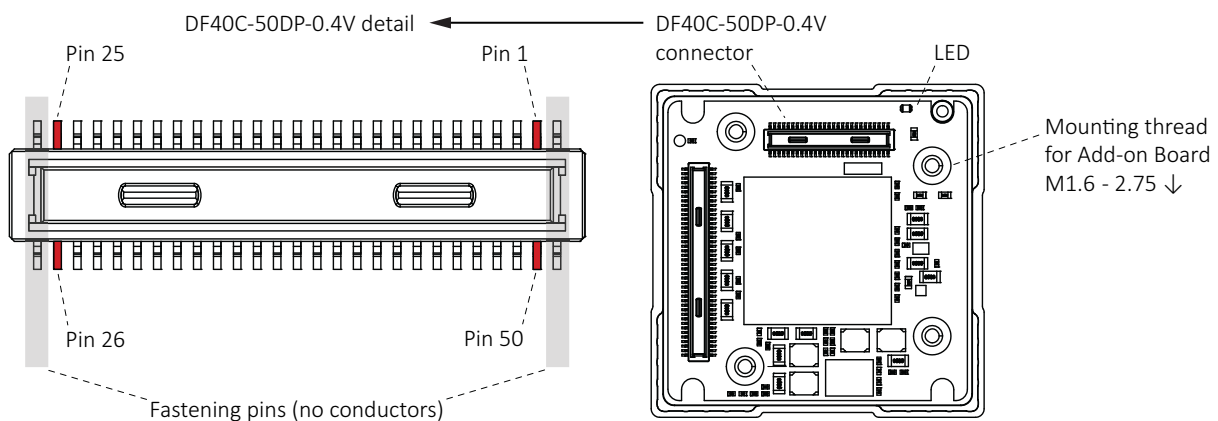

Figure 115: Alvium Flex camera back panel

DF40C 50DP-0.4V connector pin assignment

Alvium USB Flex cameras have a 50-pin Hirose DF40C-50DP-0.4V connector.



NOTICE

Damage to the camera by reverse polarity

If Alvium USB cameras or camera I/Os are powered with reverse polarity, camera electronics can be damaged.

- Use Alvium Flex accessories by Allied Vision.
- Observe polarity for camera and I/O power.

NOTICE
Damage by serial communication voltage level

If you are using serial communication (UART, similar to RS232), keep voltage levels in the range defined in [Table 143](#) on page 292. Typical RS232 voltage levels (such as ± 10 VDC) are not supported without external circuitry.

More information on Hirose DF40C-50DP-0.4V connector

- For instructions and electronic specifications of Alvim Flex accessories, see the Alvim Flex Design and Accessory Guide at www.alliedvision.com/en/support/technical-documentation/alvim-usb-documentation.
- For technical data and more instructions on the Hirose DF40C-50DP-0.4V connector, see the manufacturer data sheet at www.hirose.com.

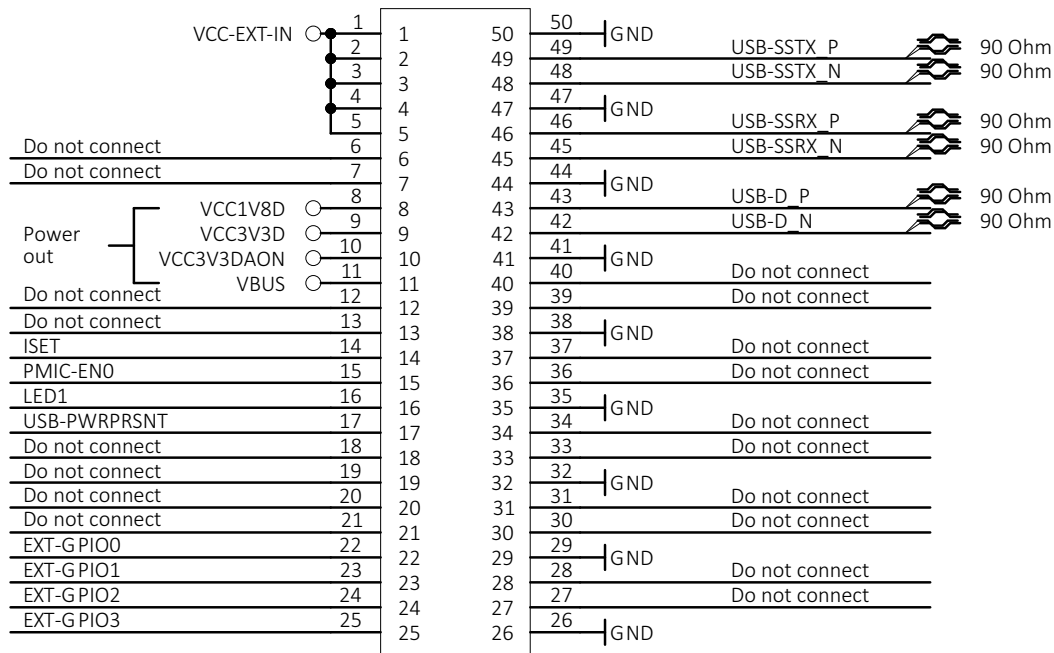

Pin	Signal	Direction	Level	Description
1 to 5	VCC-EXT-IN	PWR IN	4.5 to 5.5 VDC	Power supply voltage Maximum input current: 1.5 A
6	Do not connect			
7	Do not connect			
8	VCC1V8D	PWR OUT	max. 1.8 VDC	Power output Please contact Allied Vision Support if you want to use PWR OUT.
9	VCC3V3D	PWR OUT	max. 3.3 VDC	
10	VCC3V3DAON	PWR OUT	max. 3.3 VDC	
11	VBUS	PWR OUT	4.0 to 5.5 VDC	Power output Please contact Allied Vision Support if you want to use PWR OUT.
12	Do not connect			
13	Do not connect			
14	ISET	IN	Not applicable	To increase the camera's default internal current limit of 900 mA, connect an 820 Ω resistor to GND and add an external power supply.
15	PMIC-ENO	IN	U _{in} (low) = -0.3 to 0.4 VDC U _{in} (high) = 1.4 to 5.5 VDC	Camera power supply enable switch (active high, internal 100 kΩ pull-up resistor, default on)
16	LED1	OUT	3.3 VDC at 4 mA	Status LED output
17	USB-PWRPRSNT	IN	U _{in} (low) = -0.3 to 0.8 VDC U _{in} (high) = 2.0 to 5.5 VDC	Connect to USB-VBUS via resistor divider (R1 10 kΩ, R2 100 kΩ), add 100 nF capacitor to GND
18	Do not connect			
19	Do not connect			
20	Do not connect			
21	Do not connect			
22	EXT-GPIO0	IN/OUT	U _{in} (low) = -0.3 to 0.8 VDC U _{in} (high) = 2.0 to 5.5 VDC U _{out} (low) = 0 to 0.4 VDC U _{out} (high) = 2.4 to 3.3 VDC at max. 12 mA	GPIO: Line0 Internal pull-up resistor: 33 kΩ to 63 kΩ
23	EXT-GPIO1	IN/OUT	See Pin 22, EXT-GPIO0	GPIO: Line1 Internal pull-up resistor: 33 kΩ to 63 kΩ
24	EXT-GPIO2	IN/OUT	See Pin 22, EXT-GPIO0	GPIO: Line2 Internal pull-up resistor: 33 kΩ to 63 kΩ
25	EXT-GPIO3	IN/OUT	See Pin 22, EXT-GPIO0	GPIO: Line3 Internal pull-up resistor: 33 kΩ to 63 kΩ
26	GND	—	0 VDC	Power supply ground
27	Do not connect			
28	Do not connect			
29	GND	—	0 VDC	Power supply ground

Only signals shown in green must be connected for basic camera operation.

Table 144: Hirose DF40C-50DP-0.4V connector pin assignment (sheet 1 of 2)

Pin	Signal	Direction	Level	Description
30				Do not connect
31				Do not connect
32	GND	—	0 VDC	Power supply ground
33				Do not connect
34				Do not connect
35	GND	—	0 VDC	Power supply ground
36				Do not connect
37				Do not connect
38	GND	—	0 VDC	Power supply ground
39				Do not connect
40				Do not connect
41	GND	—	0 VDC	Power supply ground
42	USB-D_N	Defined by the USB specification		USB 2.0 differential pair
43	USB-D_P			
44	GND	—	0 VDC	Power supply ground
45	USB-SSRX_N	Defined by the USB specification		USB SuperSpeed receiver differential pair
46	USB-SSRX_P			
47	GND	—	0 VDC	Power supply ground
48	USB-SSTX_N	Defined by the USB specification		USB SuperSpeed transmitter differential pair
49	USB-SSTX_P			
50	GND	—	0 VDC	Power supply ground

Only signals shown in green must be connected for basic camera operation.

Table 144: Hirose DF40C-50DP-0.4V connector pin assignment (sheet 2 of 2)

All Alvium USB: Connections

I/O use for UART

Table 145 shows which values must be selected to control I/Os using LineSelector.

Signal	LineSelector (GenICam)	UART line
EXT-GPIO 0	Line0	Not applicable
EXT-GPIO 1	Line1	Not applicable
EXT-GPIO 2	Line2	UART Tx
EXT-GPIO 3	Line3	UART Rx

Table 145: Value settings to control I/Os using the LineSelector feature



Feature descriptions

For more information in LineSelector and SerialHub features, see the Alvium Features Reference at www.alliedvision.com/en/support/technical-documentation/alvium-usb-documentation.

Power supply voltage for I/O cables

If you are using I/O cables, voltage drops may result, causing the following issues:

- The camera cannot be operated.
- The camera does not respond to trigger pulses.
- The output signal to control devices connected to the camera is not recognized.

Compensation

To provide a proper power supply voltage, adjust the DC input voltage at the open ends of the cable as shown in Table 146.



NOTICE

Damage to camera electronics

The following values apply to the Allied Vision I/O cables shown.

If you are using your own cables, ensure the power supply voltage at the camera connector side is 4.5 to 5.5 VDC.

Product code	Length	Cable type	Power supply voltage (at the open ends of the cable)
12319	0.4 m	7-Pin JST I/O cable without screw lock to open ends	4.5 to 5.5 VDC
12322	3.0 m	7-Pin JST I/O cable with screw lock to open ends	4.5 to 5.5 VDC
17070	5.0 m	7-Pin JST I/O cable with screw lock to open ends	5 to 5.5 VDC

Table 146: Adjusted values for power supply voltage by I/O cable length



Technical data and ordering

For more information on 7-Pin JST I/O cables for Alviu USB cameras, see www.alliedvision.com/en/products/accessories.

Non-isolated, programmable GPIOs



I/O cables maximum length

The maximum length for I/O cables must not exceed 30 meters.

GPIOs description

The camera has four non-isolated GPIOs that can be configured by software to act as inputs or outputs.

Alviu GPIOs use the push-pull technology to switch the signal level between low and high. For low levels, the signal is "pulled" down towards ground level. For high levels, the signal is "pushed" up towards VCC level.

Alviu GPIOs feature the CMOS push-pull output drivers and Schmitt trigger inputs with an internal pull-up resistor and a filter circuit, shown in Figure 117. The push-pull GPIOs are able to source or sink current from an external pin.

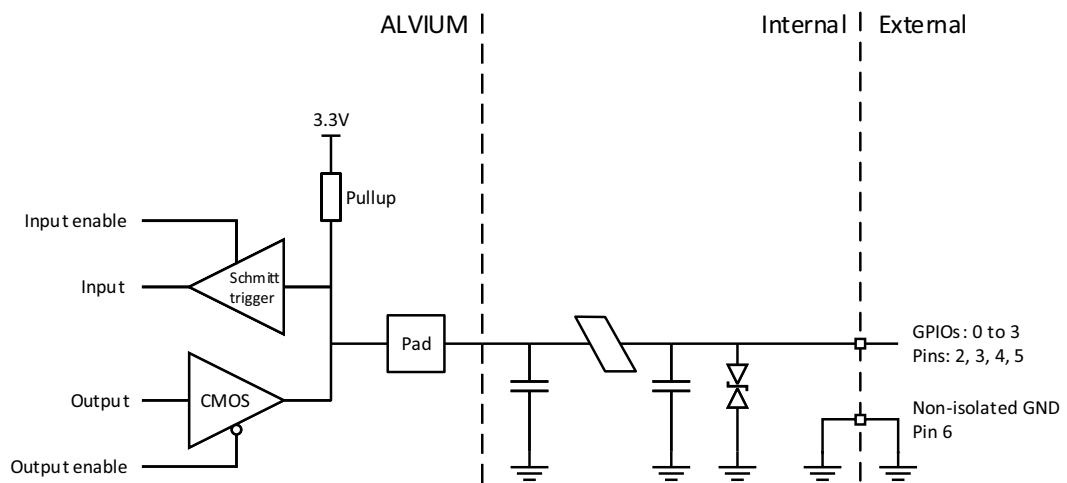

Figure 117: GPIOs block diagram

Input levels

The GPIOs can be connected directly to the system controlling the camera for voltages up to 5.5 VDC. An external resistor is not necessary.



NOTICE

Damage to the camera by high input voltage

Exceeding maximum input voltage can damage the camera.
Keep maximum input voltage below 5.5 VDC.

Parameter	Value
U_{in} (low)	-0.3 to 0.8 VDC
U_{in} (high)	2.0 to 5.5 VDC
Undefined levels	0.8 to 2.0 VDC

Table 147: GPIOs as input, voltage levels

Output levels



NOTICE

Damage to the camera by high output current or voltage

The camera can be damaged when connected to a device that exceeds the specified maximum current or voltage. Consider maximum values:

- Maximum current = 12 mA per output
- Maximum Out VCC = 3.3 VDC

Parameter	Value
External output voltage U_{out} (low)	0 to 0.4 VDC
External output voltage U_{out} (high)	2.4 to 3.3 VDC
Undefined levels	0.4 to 2.4 VDC
Maximum external output voltage	3.3 VDC
Maximum output current	12 mA

Table 148: GPIOs as output, current and voltage levels



Output voltage for U_{out} (high) = On state

The voltage level in the On state depends on the load current. Higher currents yield lower voltage.

Status LED

Alvium USB cameras have a **green** status LED. The following table describes the flashing pattern indicating different events. Inverse flashing: If the LED is already on, it is switched off for a short time.



LED settings

You can define LED settings with the `DeviceIndicatorLuminance` feature:

- `10` sets maximum LED brightness.
- `1` sets minimum LED brightness.
- `0` disables LED signaling.

Normal operation



LED code	Behavior	Status
	Continuously active	Power on or idle state
	Irregular flashing	Command or image traffic, such as for camera startup
	Four short flashes and code sequence	Error state

Table 149: LED codes for normal operation

Error conditions

Four short flashes followed by another sequence indicate errors. In this case, try the following to get the camera back to normal operation:

1. Restart the camera.
2. If the LED indicates error state again, please contact support at www.alliedvision.com/en/about-us/contact-us/technical-support-repair/-rma.

Triggering and timings



This chapter includes:

Trigger signal flow	302
Trigger latency	302
Trigger features and UserSetDefault	303
Triggering with rolling shutter cameras	303
Trigger delay with 1800 U-120 cameras	303

Trigger signal flow

Figure 118 shows an ideal diagram for the trigger signal flow. The external signal can be a physical source, such as light barrier as hardware trigger or a software trigger. This external signal starts the exposure of a frame. The end of exposure starts the readout. High levels show the active state of a signal.



Features availability

States shown in the following graphic apply to Alvium USB cameras. Not all of the corresponding features may be supported. See the Alvium Cameras Features Reference at www.alliedvision.com/en/support/technical-documentation/alvium-usb-documentation for details.

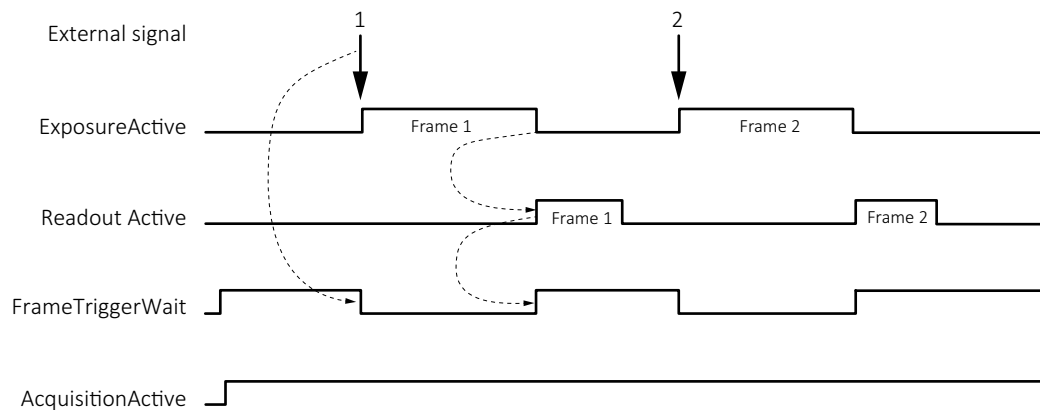

Figure 118: Schematic trigger signal flow

Term	Description
External signal	Electrical trigger signal starting the signal flow
Exposure Active	Exposing a frame
Readout Active	Reading out a frame (logical state, not a user feature)
Frame Start Trigger Wait	Waiting for a trigger
Acquisition Active	Enables frame acquisition: Expose, read out data, or wait for triggers.

Table 150: Trigger signal flow terms

Trigger latency

In theory, a trigger creates an immediate response of the camera, depending on the cable length. In practice, the computer may add a delay that is mostly unpredictable, especially on Windows systems. In addition, camera electronics and sensors have a delay.

Rolling shutter (RS) cameras in this document also have exposure delay, depending on camera settings, see [Triggering with rolling shutter cameras](#) on page 303.

Trigger features and UserSetDefault

See [Trigger features and UserSetDefault](#) on page 248.

Trigger delay with 1800 U-120 cameras

If sensor related parameters are changed **directly before** sending an external trigger, the trigger delay can be increased. This relates to [Frame rate jitter](#) on page 314.

Triggering with rolling shutter cameras

Alvium 1800 U-500, -501 NIR, -1240, and -2050

[Figure 119](#) shows how an external signal triggers exposure and readout for cameras with rolling shutter (RS) sensors. Like for global shutter (GS) sensors, readout has a constant duration, acquisition must be active to enable exposure, the end of exposure starts readout.

Rolling shutter (RS) sensors run in cycles where [readout area](#) equals [exposure area](#). Overlapping triggering is not supported. If exposure time is shorter than readout time, exposure starts with a delay:

Exposure start delay = [exposure area](#) – exposure time.

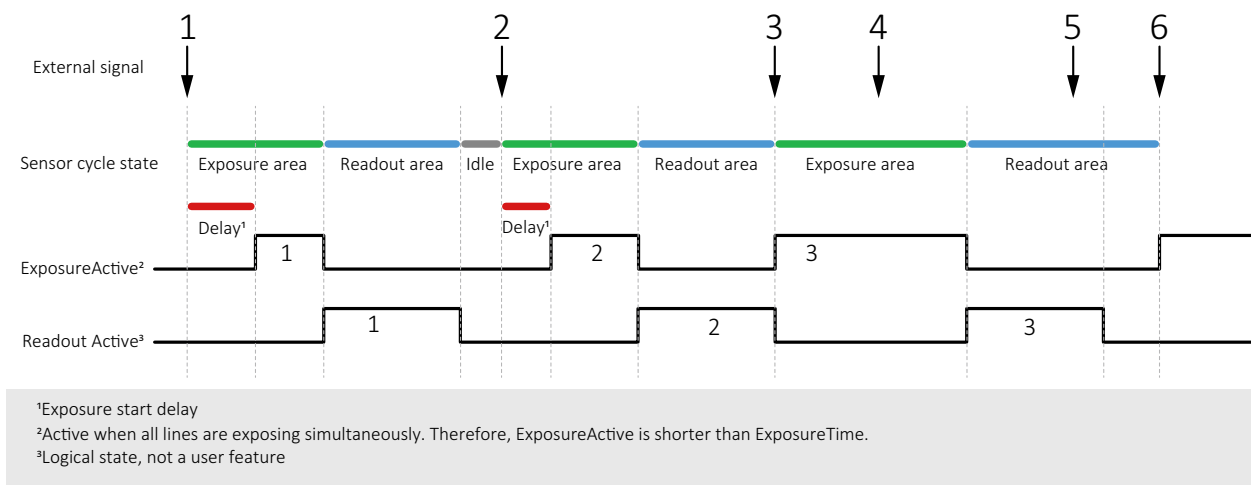

Figure 119: Triggering rolling shutter (RS) cameras

No	Conditions	Results
1	Exposure time is shorter than readout time.	Trigger 1 starts exposure 1 with a delay
2	Exposure time is shorter than readout time, but longer than for exposure 1.	Trigger 2 starts exposure 2 with a delay shorter than for exposure 1.
3	Exposure time is longer than readout time	Trigger 3 starts exposure time without a delay. Because the exposure area is longer, also the readout area is longer than for triggers 1 and 2
4	Exposure area is ongoing.	Trigger 4 is ignored.
5	Readout area is ongoing	Trigger 5 is ignored.
6	Readout area is finished. Exposure time is longer than readout time.	Trigger 6 starts exposure 6 without a delay

Table 151: Triggering conditions and results



TriggerSelector values for rolling shutter (RS) cameras

Cameras with rolling shutter (RS) **can** be triggered using *AcquisitionStart*, *AcquisitionEnd*, or *FrameStart* for TriggerSelector.

Cameras with rolling shutter (RS) **cannot** be triggered using *ExposureStart* or *ExposureEnd* for TriggerSelector.



Frame rates in triggered mode

When rolling shutter cameras are operated in triggered mode, the values for maximum frame rate reached in free run mode are cut in half.

Ignored triggers

Alvium 1800 U-500, -501 NIR, -1240, and -2050

Changing parameters while acquisition is active leads to ignored triggers until the parameters get active.

Image data flow



This chapter includes:

Image data flow diagram	306
FPNC support	307

Image data flow diagram

Figure 120 shows the order in which the features are **processed** in Alvium USB cameras. See [Value changes by feature interdependencies](#) on page 315 for the recommended order to **configure** the camera.

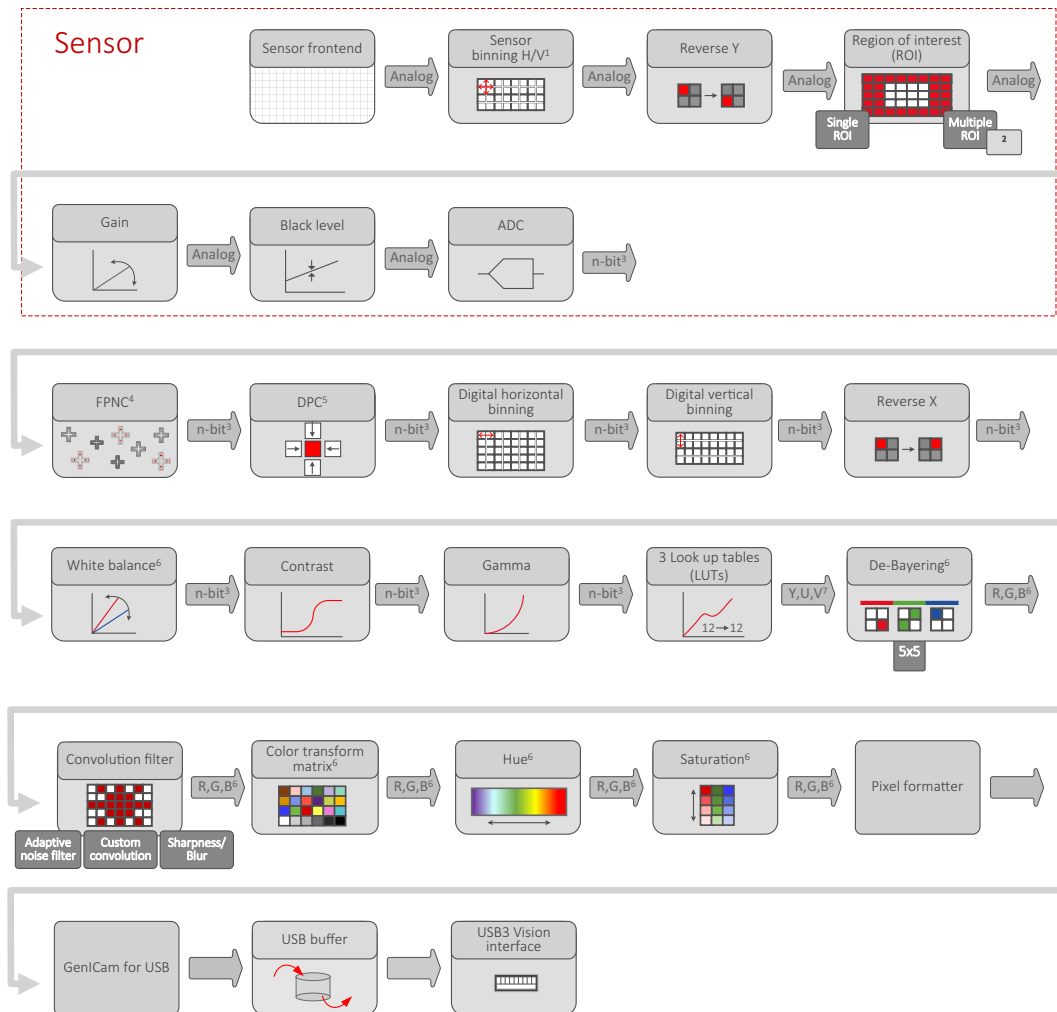

- ¹ Selected models only: See tables in the Specifications chapter.
- ² Model dependent: See tables in the Specifications chapter.
- ³ Model dependent: See ADC bit depths in the Specifications chapter.
- ⁴ Factory preset for FPNC = Fixed Pattern Noise Correction. See [FPNC support](#) on page 307 for supported models.
- ⁵ Factory preset for DPC = Defect pixel correction.
- ⁶ Color models only
- ⁷ For monochrome models: Y only

Figure 120: Image data flow of Alvium USB cameras



Feature descriptions

The shown functionalities represent features or groups of features that are described in the Alvium Features Reference. See www.alliedvision.com/en/support/technical-documentation/alvium-usb-documentation for details.

FPNC support

Table 152 shows which Alvium 1800 U models support FPNC (Fixed pattern noise correction):

Alvium model	Sensor	FPNC support	Alvium model	Sensor	FPNC support
1800 U-030 VSWIR	IMX991	-	1800 U-507	IMX264	✓
1800 U-040	IMX287	✓	1800 U-507 Pol	IMX264	-
1800 U-050	P480	✓	1800 U-508	IMX250	✓
1800 U-052	IMX426	-	1800 U-508 Pol	IMX250	-
1800 U-120	AR0135	✓	1800 U-510	IMX548	✓
1800 U-130 VSWIR	IMX990	-	1800 U-511	IMX547	✓
1800 U-131	EV76C560	✓	1800 U-530 VSWIR	IMX992	-
1800 U-158	IMX273	✓	1800 U-811	IMX546	✓
1800 U-192	EV76C570	✓	1800 U-812 UV	IMX487	✓
1800 U-203	IMX422	-	1800 U-895	IMX267	-
1800 U-234	IMX249	-	1800 U-1236	IMX304	✓
1800 U-235	IMX174	-	1800 U-1240	IMX226	✓
1800 U-240	IMX392	✓	1800 U-1242	IMX545	✓
1800 U-291	IMX421	-	1800 U-1620	IMX542	✓
1800 U-319	IMX265	✓	1800 U-2040	IMX541	✓
1800 U-320 VSWIR	IMX993	-	1800 U-2050	IMX183	-
1800 U-500	AR0521	✓	1800 U-2460	IMX540	✓
1800 U-501 NIR	AR0522	✓			

Table 152: FPNC availability by camera model

Firmware update



This chapter describes how firmware is updated on Alvium USB cameras.

Please note

You should update firmware only to change camera functions or fix known issues.

Consider: Any firmware update may not only add new features to a camera or fix known issues. It may also replace previous features or change camera characteristics. See firmware release notes for details.



Keep the camera connected

- Keep the camera and computer running during firmware updates.
- If the camera is powered down during firmware update, the camera firmware may get into a non-functional state.



Use only suitable firmware

If unsuitable firmware is used, the camera may get into a non-functional state.

- Only update to newer versions. Do not downgrade firmware to an older version, unless this has been explicitly communicated.
- We recommend updating the firmware to the next increment version only. Skipping versions may cause issues.

Firmware update with Vimba X

1. Download and install **Vimba X**.
The download includes Vimba X documentation.
2. Download the firmware (AVF file).



Downloads

- For **Vimba X**, see www.alliedvision.com/en/products/software/vimba-x-sdk.
- For firmware updates, see www.alliedvision.com/en/support/firmware.

3. Connect your Alvim camera to the host.
4. Execute the installer of the firmware updater.
The **Vimba X Firmware Updater** window opens, displaying your camera and the installed firmware version.
5. Continue with [Updating the firmware](#) on page 310.

Updating the firmware



Screenshots

The following instruction shows the firmware update on a **Linux** system. On **Linux** systems with other skins and on **Windows**, the GUI will look different.

The screenshots show an Alvium CSI-2 camera, but it applies to all interfaces.

1. Click **Open** to select the firmware for the update.

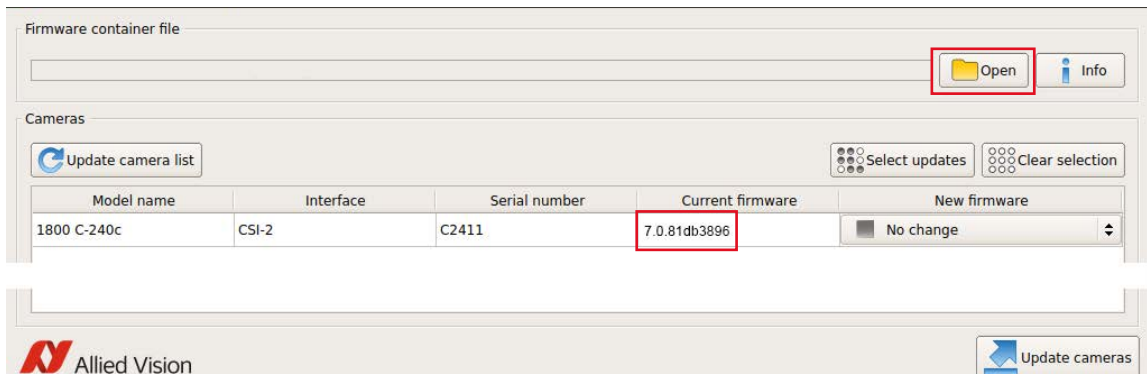

Figure 122: The camera and installed firmware are displayed

2. Select the firmware for the update from the drop-down menu.

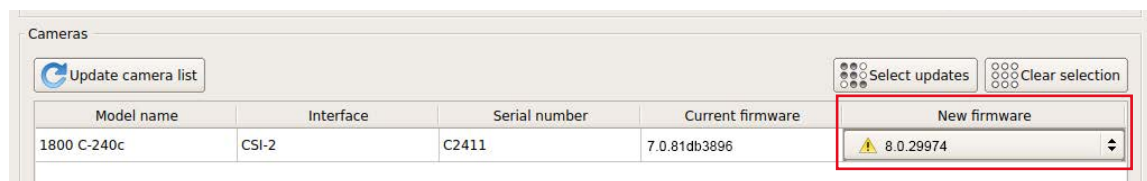

Figure 123: The firmware version is selected

3. Click **Update cameras**.

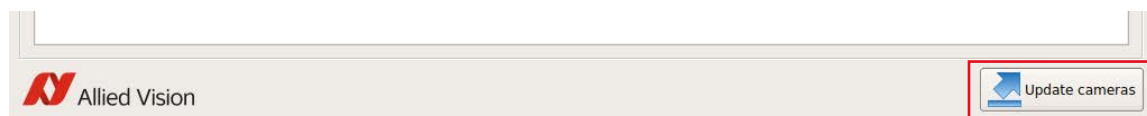

Figure 124: The update is being prepared

- Click **OK** to confirm.



Figure 125: The command to update the firmware is confirmed

The update progress is displayed.

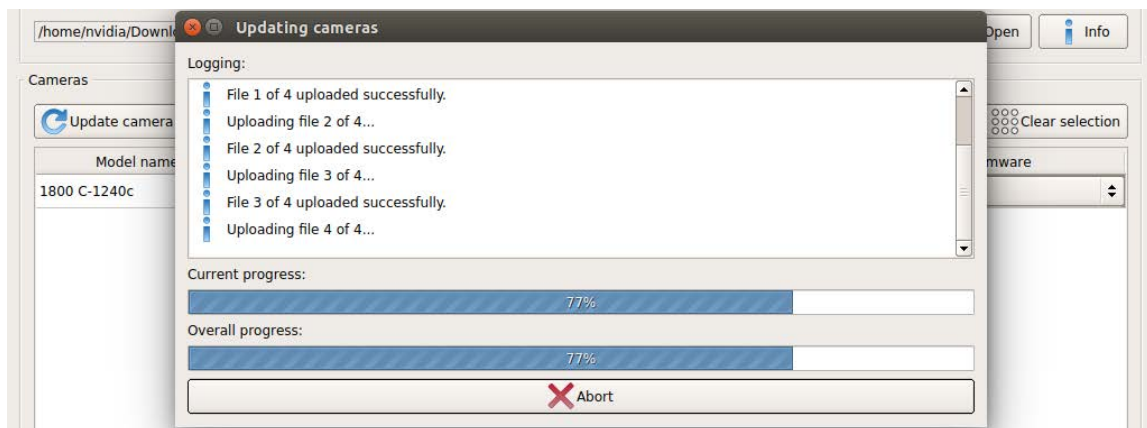

Figure 126: The update progress is displayed

- Click **Close** to confirm the completion of the update.

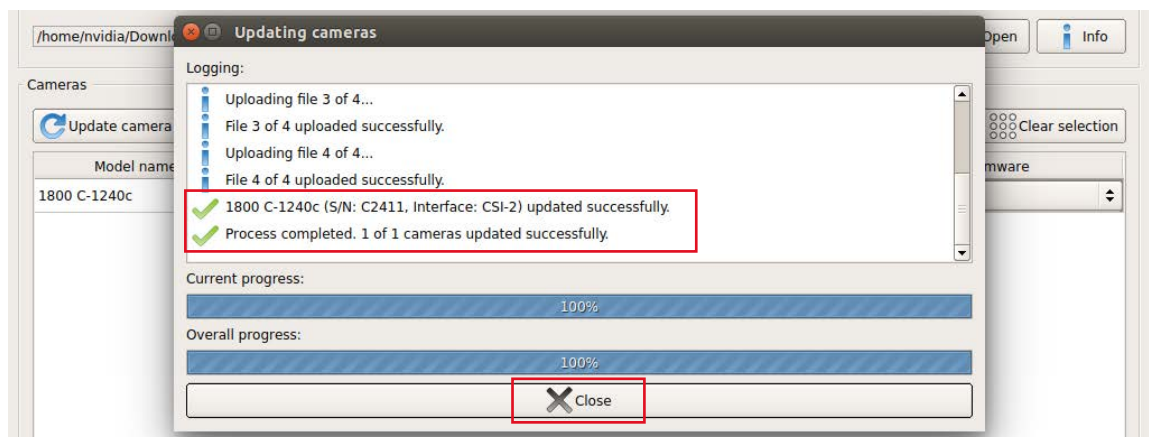

Figure 127: The update has been successfully completed

The camera is displayed with the updated firmware version.

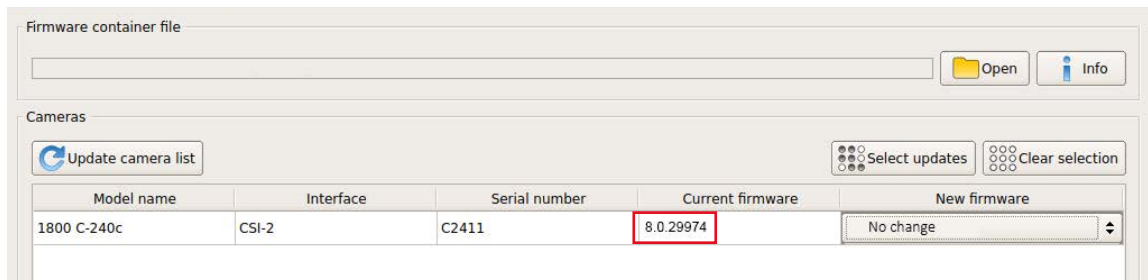

Figure 128: The updated firmware version is displayed

Error handling

If firmware update fails,

- The camera is shown as “Fallback” on the USB bus.
- The camera is not recognized by **Vimba X Viewer**.
- You can repeat the firmware update.

Should the firmware update not succeed, please contact support at www.alliedvision.com/en/about-us/contact-us/technical-support-repair-/-rma.

Performance and troubleshooting



This chapter includes:

Optimizing performance.....	314
Troubleshooting common issues	327

Optimizing performance

Image transfer with rolling shutter cameras

Alvium 1800 U-500m/c, U-501m NIR, U-1240 m/c, and U-2050m/c

If acquisition is started and stopped in a short sequence, no image is transferred to the host. The duration cannot be predicted, because it depends on various factors.

Parameter changes

If parameters are changed while these cameras are streaming, the following effects can occur.

Stopped streaming

Alvium 1800 U-500, -501 NIR, -1240, and -2050

When **AcquisitionMode** set to **MultiFrame**: If cameras are triggered by **AcquisitionStart**, the streaming stops when parameters are changed.

For **MultiFrame** acquisition, we recommend to you stop streaming before you change parameters.

Frame rate jitter

Alvium 1800 U-120, -500, -501 NIR, -1240, and -2050

Generally, some parameters can be changed during exposure without affecting the timing. For models with ON Semiconductor AR sensors and rolling shutter sensors, a different behavior must be considered for **camera operation in freerun mode without triggering**:

Changing parameters during exposure leads to frame rate jitter. When parameters are entered, the next frame starts only after readout and sensor reconfiguration delay are finished. When the camera is run in **ExposureAuto** mode, the actual frame rate is less than the calculated value for the corresponding exposure time. Consider frame rate jitter for your application, including a gap between **ExposureActive** signals.

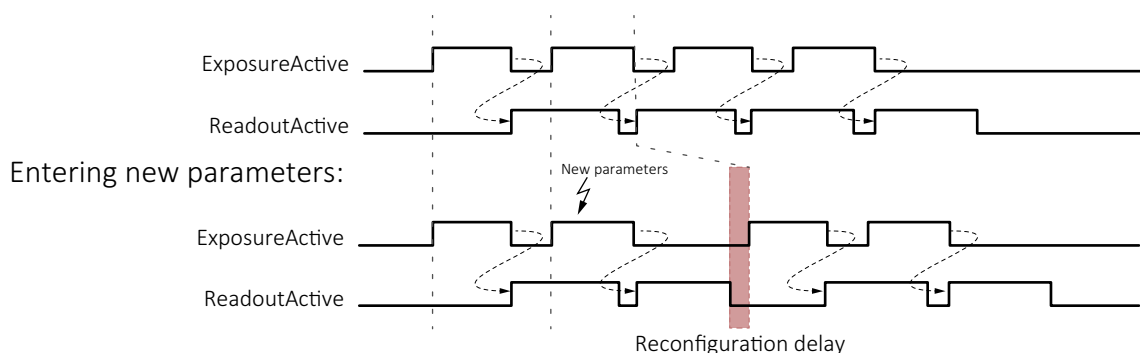

Figure 129: Delayed exposure due to parameter changes



Parameter changes in triggered mode

See [Ignored triggers](#) on page 304 for more information.

Value changes by feature interdependencies

The conversion between time and clock cycles affects control values. Features for pixel format, bandwidth, ROI, exposure time, and triggering are related to each other. Changing values for one feature can change values for another feature. For example, frame rates can be reduced when `PixelFormat` is changed subsequently. [Figure 130](#) shows the interdependencies.

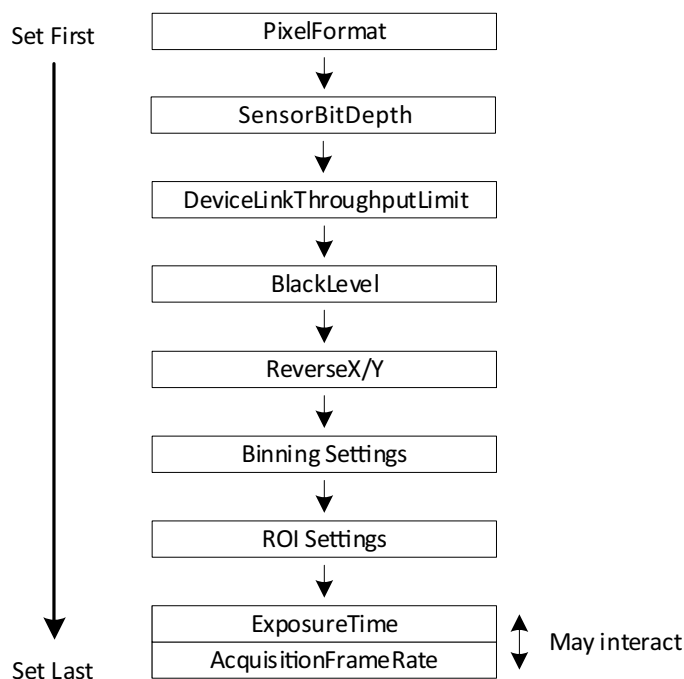

Figure 130: Interdependencies between features

Effects for the interdependent features

Changing one control's value affects other control's values, such as:

If: `Height` value is changed.

Then: Other values may be affected, such as for `AcquisitionFrameRate` and `ExposureTime`.

We recommend you to consider:

- The more features you adjust, the more current values deviate from previously set values.
- The same effects that apply to `ExposureTime`, also apply to `AutoExposure`.
- To avoid readjustments, apply settings in the order shown in [Figure 130](#).

Impact by other features

Input	Output	
	Exposure time values	Frame rate
AcquisitionFrameRate	Not affected	Affected
ExposureTime	Affected as expected	Affected
DeviceLinkThroughputLimit	Affected	Affected
Height	Not affected	Affected
Width	May be affected	May be affected

Table 153: Impact by other features

Exposure times and frame rates with Sony IMX rolling shutter cameras

Alvium 1800 U-1240 and -2050

Generally, long exposure times result in low frame rates because one is roughly the inverse of the other. With Alvium IMX RS cameras:

- The range of available frame rates depends on the exposure time.
- The exposure time must be increased when low frame rates are used.
- The available range for frame rate values depends on the exposure time. If by changing the exposure time, the previous frame rate is moved out of the available range, the frame rate is adjusted automatically.

Dark current compensation

All sensors accumulate dark current in the pixels. Dark current increases the signal level and black level. Most sensors in Alvium USB cameras compensate for this.

For **Alvium 1800 U-050m/c** with the ON Semi PYTHON 480 sensor, see [Black level compensation for 1800 U-050m/c](#) on page 318.

If cameras are operated at high temperatures or long exposure times, compensation reaches its limits. The typical compensation mechanism uses a **margin** to compensate for dark current. This works only until dark current reaches the size of the margin. The following table shows the relation of the margin and accumulated dark current for a pixel in 8-bit mode with a maximum value of 255.

Effective signal versus noise	Description
	The pixel has accumulated no dark current, the margin has maximum size.
	The pixel has accumulated some dark current, reducing the size of the margin.
The following images show a pixel that has accumulated a higher dark current than the margin.	
	The pixel has accumulated dark current, the margin reduces to 0. Type 1 compensation <ul style="list-style-type: none"> • Dark current compensation is stopped. • Dark current increases the black level. • Fixed pattern noise increases.
	The pixel has accumulated dark current, the margin reduces to 0. Type 2 compensation (Typically used for sensor-internal compensation, often in the analog domain.) <ul style="list-style-type: none"> • Dark current compensation stays active. • Maximum saturation signal decreases. • Fixed pattern noise increases.

Table 154: Accumulated dark current affecting the effective image signal

Additional compensation

If compensation limits are reached and you cannot decrease operating temperature or exposure time, what can you do to keep signal quality high?

Measures for type 1 compensation

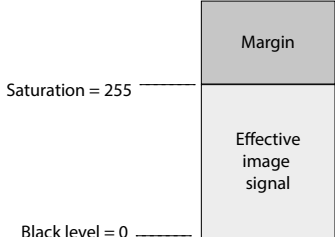
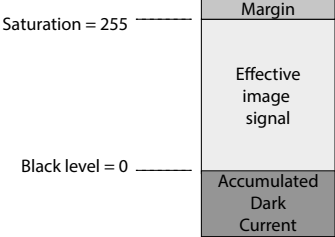
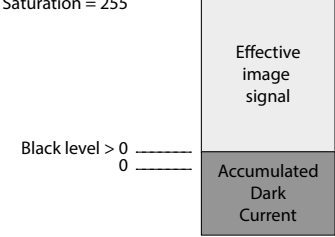
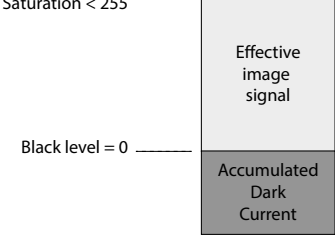
Alvium 1800 U-050m/c supports compensation type 1. For additional compensation, see [Black level compensation for 1800 U-050m/c](#) on page 318.

Typically, there is no measure to improve the image signal. The rising black level shifts black and dark gray values to gray.

Measures for type 2 compensation

All other Alvium camera models support compensation type 2.

You can increase the margin size by using gain, with the following side effects:

- To give space to a larger margin, the effective pixel capacity decreases.
- White and light gray values are shifted down to gray.

Black level compensation for 1800 U-050m/c

Because the ON Semi PYTHON 480 sensor does not have a dark current compensation, **Alvium 1800 U-050m/c** cameras have a typical black level value drift, depending on exposure time and **DeviceTemperature** (measured at the mainboard). [Table 155](#) shows the effect of the black level compensation. Should additional compensation be needed, we recommend cooling the camera.

Temperature [°C]	ExposureTime [ms]							
	1	10	50	100	250	500	750	1,000
35	Full	Full	Full	Full	Full	Full	Full	Full
40	Full	Full	Full	Full	Full	Full	Full	Full
45	Full	Full	Full	Full	Full	Full	Full	Full
50	Full	Full	Full	Full	Full	Full	Full	Full
55	Full	Full	Full	Full	Full	Full	Full	Full
60	Full	Full	Full	Full	Partial	Partial	Partial	Partial
65	Full	Full	Full	Partial	Partial	Partial	Partial	Partial
70	Full	Full	Partial	Partial	Partial	Partial	Partial	Partial
75	Full	Partial	Partial	Partial	Partial	Partial	Partial	Partial

	Full compensation
	Partial compensation

Table 155: Exposure time and temperature affecting black level compensation

Shutter types affecting image readout

Most Alvium USB camera models are operated using global shutter (GS):

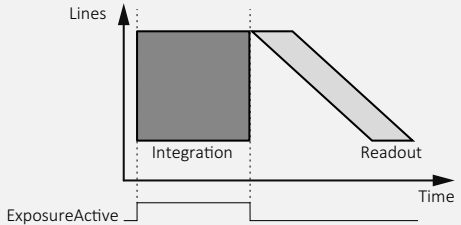
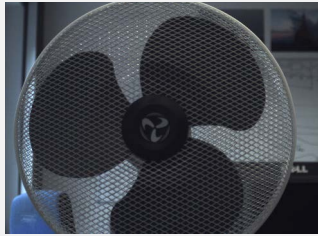
Property	Line readout	Moving image
Global shutter (GS)		

Alvium 1800 U-500 and -501 NIR models use rolling shutter (RS).

Alvium 1800 U-1240 and 1800 U-2050 models offer global reset shutter (GRS) in addition:



Property	Rolling shutter (RS)	Global reset shutter (GRS)
Line readout		
Line exposure start	Deferred from line to line	Common for all lines
Line exposure time	Common for all lines	Increases from line to line
Image acquisition of moving objects		
Image brightness	Constant over the image	Varying over the image
Moving objects	Distorted shape	Shape without distortion
Typical application	Static objects	Moving objects
Compensation	Use an additional mechanical shutter or use a strobe light:	
		

Table 156: Shutter types affecting image readout

Host setup and bandwidth

If the camera data output exceeds the bandwidth supported by the host computer, images may be corrupted. This section gives some background information to enable proper image transfer.

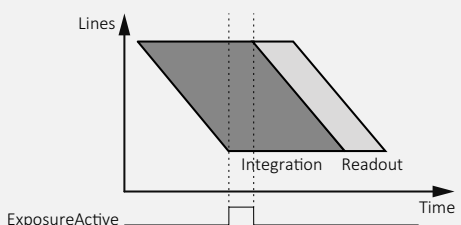
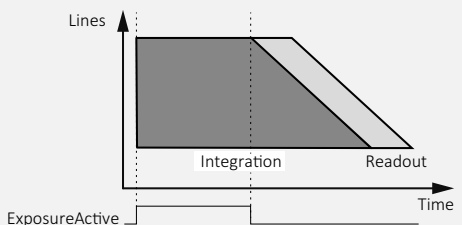
Sensor data output and camera data output

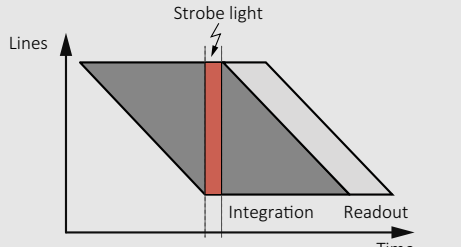
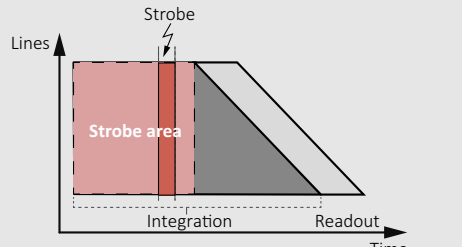
For cameras with an image buffer, the required bandwidth for image acquisition can be estimated for a given frame rate, pixel format, and resolution by over-the-thumb calculations. Alvim cameras do not have an image buffer.

Figure 131 shows the bandwidth for a higher (1) and a lower (2) value for `DeviceLinkThroughputLimit`.

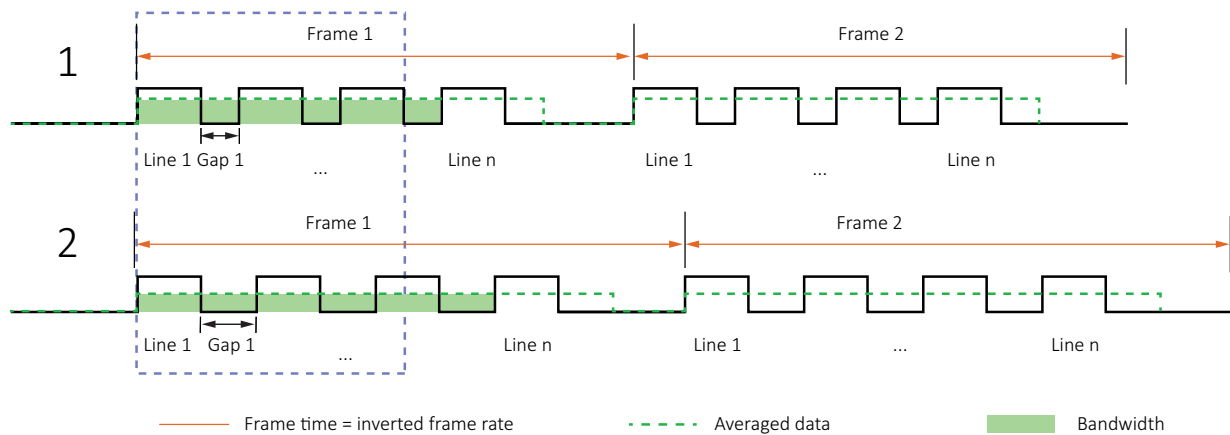

Figure 131: Sensor data output and camera data output

- Cameras **without** an image buffer like Alvim: Data is averaged over the line time.
- Cameras **with** an image buffer: Data rate is averaged over the frame time.
- Using `DeviceLinkThroughputLimit`: Reduce the maximum line data rate.

`DeviceLinkThroughputLimit` controls the maximum bandwidth of the data streamed out by the camera. When the value for this feature is reduced, the gaps between the lines are increased. This reduces the frame rate and therefore the bandwidth.

Additionally, you may reduce the frame rate to reduce bandwidth.

Consider that **Vimba X Viewer** does not gray out values that exceed the bandwidth supported by the host computer.



More information on `DeviceLinkThroughputLimit`

For more information on `DeviceLinkThroughputLimit`, see the Alvim Cameras Features Reference at www.alliedvision.com/en/support/technical-documentation/alvim-usb-documentation.

Vimba X settings

During freerun, Alvium cameras do not automatically adapt the frame rate to the USB controller's limits. If the data rate is too high for your USB controller, it receives corrupted frames. The image transfer status in **Vimba X Viewer** is signaled as **Running**. However, the corrupted frames are not displayed.

Requirements for USB PCIe cards and host controllers

Ensure sufficient bandwidth is supported by the USB host adapter cards **and** by the corresponding USB PCIe host controllers on your host system. 450 MByte/s are required to reach maximum frame rates for some Alvium USB camera models. Adding the typical overhead for USB communication, even 500 MByte/s can be insufficient. We recommend using roughly **1 GByte/s per camera**.

In [Table 157](#) you can see that, for example, Version 1.1 PCIe host controllers with 1 lane do not support the bandwidth required to operate a single camera at full performance.

Lanes ↓	Throughput		
PCIe version →	1.0 / 1.1	2.0 / 2.1	3.0 / 3.1
× 1	250 MByte/s	500 MByte/s	0.99 GByte/s
× 2	500 MByte/s	1 GByte/s	1.97 GByte/s
× 4	1 GByte/s	2 GByte/s	3.9 GByte/s

Table 157: Requirements for USB PCIe host adapters

Potential limitations with 4-port cards

Observe that some 4-port PCIe cards have limitations: They use shared resources and do not support the required bandwidth when each port is used.



Suitable USB 3.0 accessories

See www.alliedvision.com/en/products/accessories for suitable USB 3.0 or 3.1 Gen 1 host controller cards and cables or contact your Allied Vision Sales representative.

Shared bandwidth on a common USB bus

Ideal setup for two cameras

Preconditions

- Control traffic is ignored.
- The possibility of the host being busy with other tasks is ignored.
- Cameras share 100% bus bandwidth.
- Cameras need 100% bus bandwidth in total.
- Cameras stream in the same way because they are the same model and have identical settings.
- No other device is connected.

Result

- Bandwidth is divided by two, cameras get assigned 50% bandwidth each. For three cameras, the bandwidth is 33.3% each.
- If one camera sends no data, the other camera will be assigned 100% bandwidth. To always assign 50% to both cameras, they have to be controlled to use no more than 50% bandwidth each.
- If the computer cannot process the images received from a camera, images are corrupted.

Best practice for bandwidth management

- To assign maximum bandwidth to a camera, make sure your camera is the only device on the bus.
- Avoid devices, such as a monitor or a mouse, sharing bandwidth with the USB camera connected to the same bus.
- For maximum bandwidth, use a current version host controller card. See www.alliedvision.com/en/products/accessories.
- USB3 Vision devices use bulk transfer. Avoid using other transfer modes.
- Control bandwidth by assigning the desired amount to the separate cameras.

Cascading hubs divide bandwidth

The following example applies to standard behavior without individual settings. The graphics show bandwidth distribution on a common bus. Three cameras try to use full bandwidth at the same time. If one camera is inactive, the host will provide its share to the others until this camera sends data again. See [Figure 132](#) on page 322.

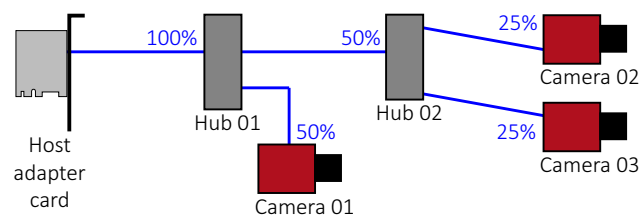

Figure 132: Bandwidth assignment for cascading hubs

DevicePowerSavingMode

If you want to pause camera operation, you can use **DevicePowerSavingMode** to reduce the power consumption of Alvium USB cameras.

For example, with *SuspendMode* (**U3 mode**), the remaining power consumption is approximately 0.1 W. With *StandbyMode*, the remaining power consumption is approximately 1.1 W (with external power as well as with USB Power) for all models.

In this section, you learn to change between operational mode and U3 mode by **DevicePowerSavingMode** and host or backend commands.

The **DevicePowerSavingMode** feature selects between standard power use and various power saving modes, avoiding unexpected camera behavior:

Values	Description
<i>Disabled</i>	The camera uses standard power (default).
<i>StandbyMode</i>	Camera functions are disabled to reduce power consumption. However, the control channel is maintained active: the camera can still be controlled by GenICam features.
<i>SuspendMode</i> Recommended with Linux.	The camera is enabled to go into USB U3 power saving mode. The Phy shuts the camera down. The host must send a DevicePowerSave command or a respective backend command to the camera to apply <i>SuspendMode</i> . The camera reboots itself. After reboot, all camera settings are reset to default values, DevicePowerSavingMode is reset to <i>Default</i> .

Table 158: Options for DevicePowerSavingMode



Please observe

The U3 mode is not supported for USB 2.x connections.



Using power saving modes

StandbyMode

Use **DeviceReset** command to switch from *StandbyMode* back to *Disabled* for standard power mode.

SuspendMode

- [Using SuspendMode under Linux](#) on page 324
- [Using SuspendMode under Windows](#) on page 325

Using SuspendMode under Linux

Activating U3 mode

1. Connect to the camera and use as you like.
2. Set `DevicePowerSavingMode` to `SuspendMode`.
3. Close all **Vimba X** connections, including the first **Vimba X Viewer** dialog.

Linux requires to change the following settings to bring a USB device to U3 mode:

- `power/control => auto`
- `power/autosuspend_delay_ms => 0`

The following script to put the camera to U3 mode can be used on most hosts.

4. Execute this script with root privileges. For example, save this script as **U3.sh** and use the command `sudo ./U3.sh`:

```
#!/usr/bin/env bash

# https://www.kernel.org/doc/html/v4.13/driver-api/usb/power-
management.html#the-user-interface-for-dynamic-pm
find -L /sys/bus/usb/devices/ -maxdepth 2 -regextype posix-
extended -regex '/sys/bus/usb/devices/[0-9]+\-[0-9]+' | while
read port; do
    if [[ $(< $port/idVendor) == "1ab2" ]]; then
        if [[ $1 == on ]]; then
            echo "Activating port: $port"
            echo on > $port/power/control
            echo 2000 > $port/power/autosuspend_delay_ms
        else
            echo "Suspending port: $port"
            echo auto > $port/power/control
            echo 0 > $port/power/autosuspend_delay_ms
        fi
    fi
done
```

Code Listing 1: Linux script to change to U3 mode

Reactivating operational mode

Open **Vimba X Viewer**.

The camera boots up. This may take about 2 seconds.

Using SuspendMode under Windows

Activating U3 mode

1. Connect to the camera and use as you like.
2. Set the `DevicePowerSavingMode` to `SuspendMode`.
3. Close all **Vimba X** connections, including the first **Vimba X Viewer** dialog.
4. In the **Device Manager**, click **Disable Device** for the Allied Vision USB3 Vision Device:

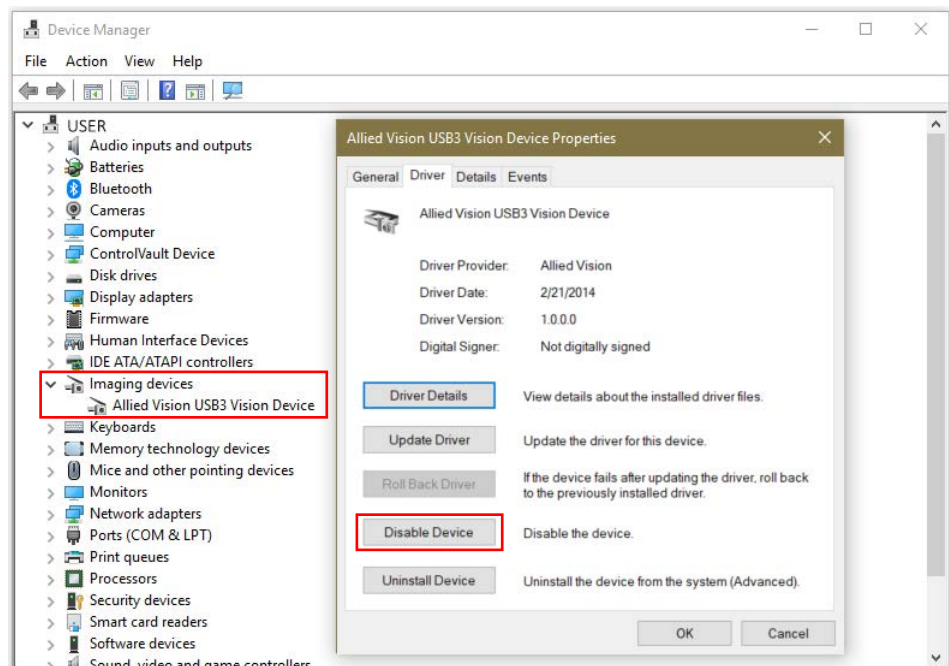

Figure 133: Disabling the Alvim camera in the Device Manager

Reactivating operational mode

1. In the **Device Manager**, click **Enable Device** for the Allied Vision USB3 Vision Device:

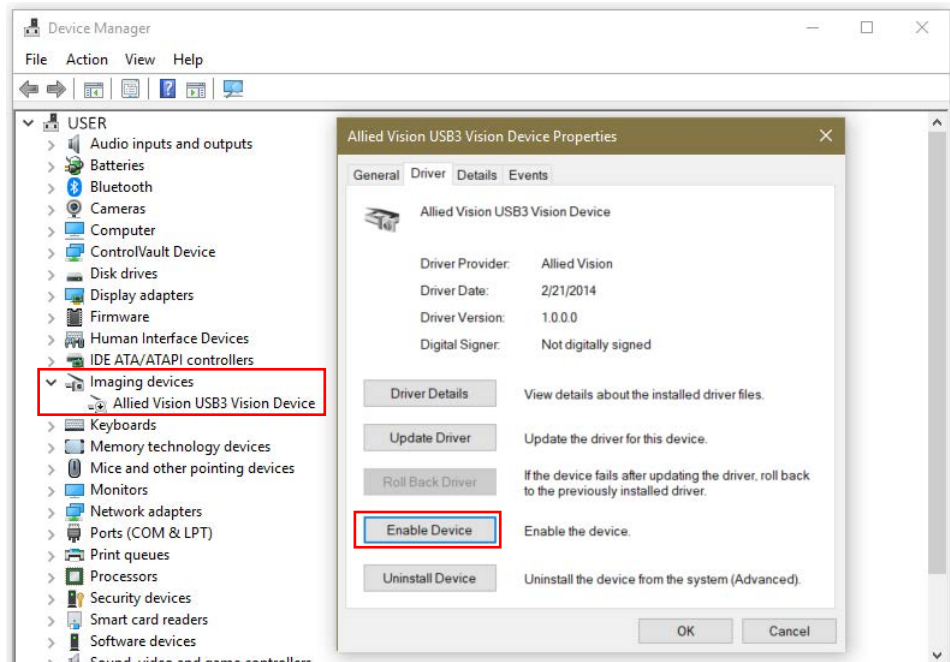

Figure 134: Enabling the Alvium camera in the Device Manager

2. Open **Vimba X Viewer**.

The camera boots up. This may take about 2 seconds.

Power consumption issues

The power consumption of cameras is caused by such as the image sensor and enabled features. The total power for the host system also includes the USB cable loss. Unfavorable setups can prevent your system from working. What can you do?

Ensure sufficient power supply

Your host system must provide sufficient voltage and current at the USB downstream connector on the host system for proper camera operation. If this is not the case, we recommend you to power cameras by an external power supply, using the I/O connector (see [Camera interfaces](#) on page 289 for details).

Reduce the power consumption

This applies **only if cameras are powered via USB**. When Alvium USB cameras begin to exceed the maximum current allowed by the USB 3.0 standard, cameras are automatically shut down.

Some features increase the power consumption:

- ConvolutionMode
- SensorBitDepth

Try not to use these features at the same time to reduce the power consumption.



Support

If you are still facing issues, please contact support at www.alliedvision.com/en/about-us/contact-us/technical-support-repair-/-rma.

Troubleshooting common issues

In this section you can find questions and answers about problems with camera operation. The events are ordered from general to detail:

- [Camera recognition](#)
- [Unexpected events](#)
- [Performance](#)
- [Radio signal interference](#)

Each entry consists of:

- Observed unwanted event, numbered for easier handling
- Short description of the solution
- Step-by-step instructions to resolve the issue.



Hardware installation

For background information, see [Installing the camera](#) on page 269.

Camera recognition

How can I make the computer and Vimba X Viewer recognize the camera?

1. Check if the **hardware** supports your USB camera.
Is the power supply sufficient to operate the camera? See [Power consumption issues](#) on page 326.
See www.alliedvision.com/en/products/accessories.

Windows only

2. Check if your computer has an appropriate **USB 3.0 or 3.1 Gen 1 host controller driver** installed.
Windows 8 and later OS provide a USB 3.0 or 3.1 Gen 1 host controller driver. On a properly installed OS, no problems should occur.
Windows 7 and earlier OS do not provide a USB 3.0 or 3.1 Gen 1 host controller driver.
To install the host controller card:
Download the manufacturer USB 3.0 or 3.1 Gen 1 host controller driver.
Install the driver on your computer.
Result: The installed driver enables the host controller.

Windows only

3. Check if the **USB3 Vision device driver** is properly installed and assigned to the camera.
Follow the instructions in [Installing the host adapter and Vimba X](#) on page 284.
4. The camera, **connected to a USB 3.0 or 3.1 Gen 1 hub**, is not recognized anymore. Check if the USB 3.0 or 3.1 Gen 1 hub has crashed.
 1. Disconnect the USB and power supply cable from the hub.
 2. Reconnect both.Result: The camera is recognized again.
5. The camera, **connected directly to the computer**, is not recognized anymore. Check if a hub included in the **USB host controller** has crashed.
 1. In the **Device Manager**, deactivate the host controller.
For **Windows**, see [Installing the camera driver with Windows tools](#) on page 287.
 2. Reactivate the host controller.Result: The camera is recognized again.

Unexpected events

How do I get the camera back to normal operation?

1. Check if the **camera is active**.
 - If: The camera is shut down after changing feature settings.
 - Then: Restart the camera with previous settings used before the changes. Read how to [Reduce the power consumption](#) on page 327.

2. Check if an error is shown by the **camera Status LED**.
 - If: The status LED signals four short flashes followed by another sequence.
 - Then: Restart the camera.
 - If: If the status LED again signals four flashes.
 - Then: Please contact support at www.alliedvision.com/en/about-us/contact-us/technical-support-repair/-rma.

3. Check if **power cables**, such as cables with a high current in the environmental setup, **harmfully interfere with camera cables**.
 - If: Any camera cable crosses or goes parallel with a power cable.
 - Then: Separate camera cables from power cables.

4. Make sure the **camera is intact**.
For this, exclude issues of the cable or the connected computer:
 1. Connect the camera with a **different cable** to a **different computer**.
 - If: The camera works properly.
 - Then: The camera is intact, but your previous computer or cable has a defect. Continue with 2.
 - If: The camera does not work properly.
 - Then: Most likely, the camera has a defect. Please contact Allied Vision support.
 2. Connect the camera with the **previous cable** to the **different computer**.
 - If: The camera works properly.
 - Then: Replace the cable.
 3. Connect the camera with the **replaced cable** to the **previous computer**.
 - If: The camera does not work properly.
 - Then: Check the computer to fix the issue.

Why does the camera not transfer images?

1. The value for `DeviceLinkThroughputLimit` is set higher than the bandwidth supported by the host system.
Then: Check if sufficient bandwidth is assigned to the camera. See [Host setup and bandwidth](#) on page 320.
2. The camera is **connected to a USB 2.0 port** and requires a bandwidth higher than 50 MByte/s.
Then: Connect the camera to a USB 3.1. Gen 1 port.

Performance

How can I improve camera performance?

1. Check if the **hardware** sufficiently supports your USB camera.
See www.alliedvision.com/en/products/accessories.
2. Check if the **USB host adapter card and the USB PCIe host controller** support the available bandwidth.
See [Requirements for USB PCIe cards and host controllers](#) on page 321.
3. Check if the **camera shares the bus with other devices** reducing the available bandwidth.
Connect the camera to an individual bus, not shared by other devices.
For more information, see [Shared bandwidth on a common USB bus](#) on page 322.
4. Check if the **camera is connected to cascading hubs**, reducing the available bandwidth.
Attach devices directly to a separate USB 3.0 or 3.1 Gen 1 bus. If you want cameras to share a common bus, use only a single hub to attach devices. For more information, see [Shared bandwidth on a common USB bus](#) on page 322.
5. Check if all your USB **accessories support USB 3.0 or 3.1 Gen 1**.
For recommended USB accessories, see www.alliedvision.com/en/products/accessories.

Radio signal interference

How can I avoid radio signal interference from wireless devices?

Ensure camera installation complies with **Electromagnetic Compatibility**.

Wireless devices and USB 3.0 or 3.1 Gen 1 commonly use 2.4 GHz frequency (WLAN includes 2.4, 3.6, and 4.9 GHz).

Even USB 3.0 and 3.1 Gen 1 cables can interfere harmfully with other electromagnetic devices. For example, despite shielding, a USB 3.0 or 3.1 Gen 1 cable can interfere with a wireless mouse. Tests have shown an increase of the noise floor up to 20 dB for the affected devices.

- To enable maximum bandwidth, 2.4 GHz radio frequencies must be avoided; therefore, use **maximum shielded cables only**.
- Keep **maximum distance** between your Alvium USB camera setup and interfering devices.
- Use **high-gain antennas** to reduce power of the radio signals.

For tested USB accessories, see www.alliedvision.com/en/products/accessories.

Index

A	
Allied Vision contact	21
Alvium Flex	
dimensions and mass.....	235
interface connection.....	293
overview.....	17
technical drawings	236
Alvium Frame	
aligning.....	276
dimensions and mass.....	240
installing.....	276
mounting.....	278
overview.....	19
sensor position accuracy	246
technical drawings	240
Alvium Frame Flex	
dimensions and mass.....	241
technical drawings	242
B	
bandwidth	
cascading hubs.....	322
division on a common bus.....	322
troubleshooting	320
bare board cameras.....	270
BIOS drivers	71
C	
camera identification	
Model ID.....	59
serial numbers	271
camera installation	
drivers for camera and host adapter.....	284
Windows	284
CE	59
China RoHs.....	59
compliance.....	59
connectors	289
conventions in this document.....	54
current and voltage	66
D	
DevicePowerSavingMode.....	323
digital binning	81
dimensions and mass	
Alvium Flex	235
Alvium Frame	240
Alvium Frame Flex.....	241
standard Alvium	218
document	
conventions	54
history.....	32
overview	15
terms	56
driver installation	283
E	
ESD	65
ExposureMode and exposure times.....	78
F	
features	
availability.....	249
interdependencies	315
firmware update	309
flange focal distance	218
FPC connectors, pin assignment.....	293
frame rate	
reference settings	79
rolling shutter sensors.....	79
Sony IMX rolling shutter.....	316
G	
GenICam.....	73
global reset shutter (GRS).....	319
global shutter (GS)	319
GPIOs	
input levels	299
output levels.....	299
ground	293
ground loops	66
H	
hardware assembly	
aligning Alvium Frame.....	276
camera mounting - Alvium Frame	278
camera mounting - bare board.....	273
camera mounting - housed cameras	275
heat sink mounting.....	272
lens mounting.....	279
heat dissipation.....	63

Hirose DF40C-50DP-0.4V		
description	293	
safety	67	
host controller requirements	321	
hubs	322	
I		
image data flow	306	
intended use	62	
interfaces	289	
IR cut filter	244	
K		
KC	59	
L		
lanes	293	
LED	300	
lenses	252	
focal length vs. field of view	254	
maximum protrusion	70	
mounting	279	
vignetting	253	
M		
maximum protrusion		
safety	243	
MutipleRegions	82	
N		
naming	56	
P		
performance	314	
pin assignment	293	
power consumption		
reference settings	85	
Q		
quantum efficiency	76	
R		
radio signal interference	331	
readout modes	77	
rolling shutter (RS)	319	
S		
safety	2, 8, 62	
bare board cameras	68	
BIOS drivers	71	
camera power	66	
electrical connections	65	
GPIOs	66	
ground loops	66	
heat dissipation	63	
heat sinks	71	
Hirose DF40C-50DP-0.4V	67	
lens mounts	62	
maximum protrusion	70	
optical components	68	
PCBAs	65	
sensor	69	
USB cables	67	
USB host controllers and hubs	67	
sensor ADC readout modes	77	
sensor binning	82	
sensor cleanliness (definition)	69	
sensor handling	69	
sensor position accuracy	245	
shift and rotation with Alvim Frame	246	
standard and Alvim Flex	245	
shock and vibration	74	
S-Mount lenses	254	
mounting	280	
software installation	283	
specifications	72	
standard Alvim		
dimensions and mass	218	
technical drawings	220	
streaming is stopped	314	
support	21	
T		
technical drawings		
Alvim Flex	236	
Alvim Frame	240	
Alvim Frame Flex	242	
standard Alvim	220	
term definitions	56	
triggering	301	

troubleshooting	313	U	
camera recognition	328	U3 mode	323
frame rate jitter	314	UART	297
parameter changes	314	UKCA	59
performance	330	USB	
radio signal interference	331	host controller requirements	321
streaming is stopped	314	USB 2.0	68
unexpected events	329	USB cables	67
troubleshooting		USB host controllers and hubs	67
bandwidth	320, 322	USB3 Vision	73
black level compensation	318	user sets	248
dark current compensation	316	W	
shutter types and image readout	319	WEEE	59
		white balance default	217