



Key Features

- Large-area, tiled detectors with active area up to 30 x 30 cm
- 5 or 10 lp/mm resolution (99 or 49.5µm pixel)
- Gigabit Ethernet or Camera Link interface
- 14-bit digital video output
- Energy range 10 - 225 kV
- Ready-to-run software and drivers

Applications

- Industrial inspection, biomedical and scientific

Rad-icon Large-Area Industrial X-Ray Detectors

Overview

Teledyne DALSA's *Rad-icon* product family of large-area digital x-ray cameras offers users a high-speed, high-performance x-ray imaging detector with a fast, reliable PC interface (either GigE or Camera Link) for easy integration. The Rad-icon product line leverages Teledyne DALSA's advanced CMOS image sensing technology, which enables the delivery of low-dose x-ray images and yields higher image quality than a-Si flat panels and image intensifier devices. The detectors in this product line are capable of frame rates up to 66 fps, and communicate via a standard Cat6e or Camera Link data cable over lengths up to 100m.⁽¹⁾

Rad-icon detectors are available with different Gd₂O₂S (GadOx) or CSI scintillator options to address a range of resolution and sensitivity requirements. The camera interface allows easy access to features such as adjusting the frame rate, single and multiple frame acquisitions, and control of advanced timing modes. Each detector ships with user-friendly software tools for stand-alone operation or easy integration with your application software.

⁽¹⁾ Max. cable length for CameraLink models is 7 m.

Camera Options

Device	Pixels	Pixel size	Active Area	Max. Frame Rate
Rad-icon 0720	688 x 2064	99 µm	6.8 x 20.4 cm	66 fps ²
Rad-icon 1520	1548 x 2064	99 µm	15.3 x 20.4 cm	25 fps ²
Rad-icon 3020HS	3076 x 2064	99 µm	30.5 x 20.4 cm	50 fps
Rad-icon 0723HS	1254 x 4608	49.5 µm	6.3 x 22.8 cm	50 fps
Rad-icon 1523HS	2930 x 4608	49.5 µm	14.6 x 22.8 cm	20 fps
Rad-icon 2329HS	4608 x 5870	49.5 µm	22.8 x 29.1 cm	20 fps
Rad-icon 3030HS	3076 x 3096	99 µm	30.5 x 30.6 cm	50 fps

⁽²⁾ TurboDrive enabled

Specifications

Detector Specifications	Value	Units
Typ. dark current (23°C) ⁽¹⁾	20	ADU/s ⁽²⁾
Read noise (rms)	4-6	ADU
Typ. dynamic range	3000:1	
Digitization	14	bits
Image lag	<0.1	%
Non-linearity (10..90% FS)	<2	%
Typ. readout period ^(3,4)	20-40	ms
Max. frame rate (full res.) ⁽⁴⁾	50	fps
Output (pixel) data rate	40	MHz

⁽¹⁾ dark current doubles approx. every 8°C

⁽²⁾ ADU = Analog-Digital Unit = 1 LSB (Least Significant Bit)

⁽³⁾ time required to transfer image from sensor to camera memory

Electrical Specifications	Value	Units
Typical supply voltage	12.0	Volts
Supply voltage range	11 to 26	Volts
Maximum supply current ⁽⁴⁾	3.0	Amps
Typical power dissipation ⁽⁴⁾	10-20	Watts
Camera interface ⁽⁴⁾	(5 or 10)Gigabit Ethernet or CameraLink	
Trigger connector	TTL	

General Specifications	Value	Units
Operating temperature	+10 to +40	°C
Storage temperature	-10 to +55	°C
Humidity (non-condensing)	20 to 80	% R.H.
Weight ⁽⁴⁾	4-8	kg

⁽⁴⁾ depends on detector model

Resolution & Sensitivity

The Rad-icon detectors are designed to work with x-ray sources operating at a wide range of kVp settings. X-ray energies as low as 10-15 keV can be detected. The cameras can be used with x-ray energies as high as

Rad-icon Product Family Datasheet

225kV, although we recommend the use of additional shielding and/or collimation at higher energies in order to protect the sensor element and electronics from damage.

The pixel spacing of each camera model determines the limiting resolution of the sensor. The actual Modulation Transfer Function (MTF) of the detector depends on the type of scintillator that is installed. A thicker phosphor screen will produce more signal, but at the expense of high-frequency contrast. Typical MTF curves for the two standard scintillator options are shown in the graph below.

Detector	Typical Sensitivity [ADU/ μ R] ⁽¹⁾	
	50kVp	80kVp
Rad-icon 0720/1520/2022/3030(HS) (With UHR)	3.8	5.0
Rad-icon 0720/1520/2022/3030(HS) (with DRZ-Std)	9.7	13.7
Rad-icon 0723HS/1523HS (with UHR)	2.4	
Rad-icon 2329HS (with UHR)	2.4	

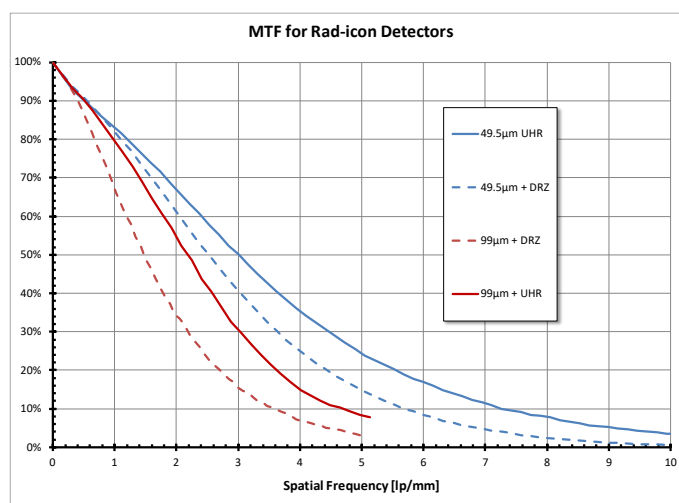

⁽¹⁾ W target, 2 mm glass window, no filtration

Software

Each Rad-icon detector ships with our ShadoCam Imaging application, Teledyne DALSA's CamExpert software and a Gigabit Ethernet driver (if applicable). The software is compatible with Windows 7, 8 and 10. Check with your sales representative for compatibility with other Windows versions or with the Linux operating system. The Ethernet models can be connected on a network, but for optimal performance a dedicated network adapter is highly recommended.

For writing custom applications to acquire images from the detector, we recommend using Teledyne DALSA's Sopera Essential, or the Sopera LT SDK (free download available at <http://www.teledynedalsa.com/imaging/products/software/sopera/lt/>).

Mechanical Dimensions Rad-icon 0720/1520

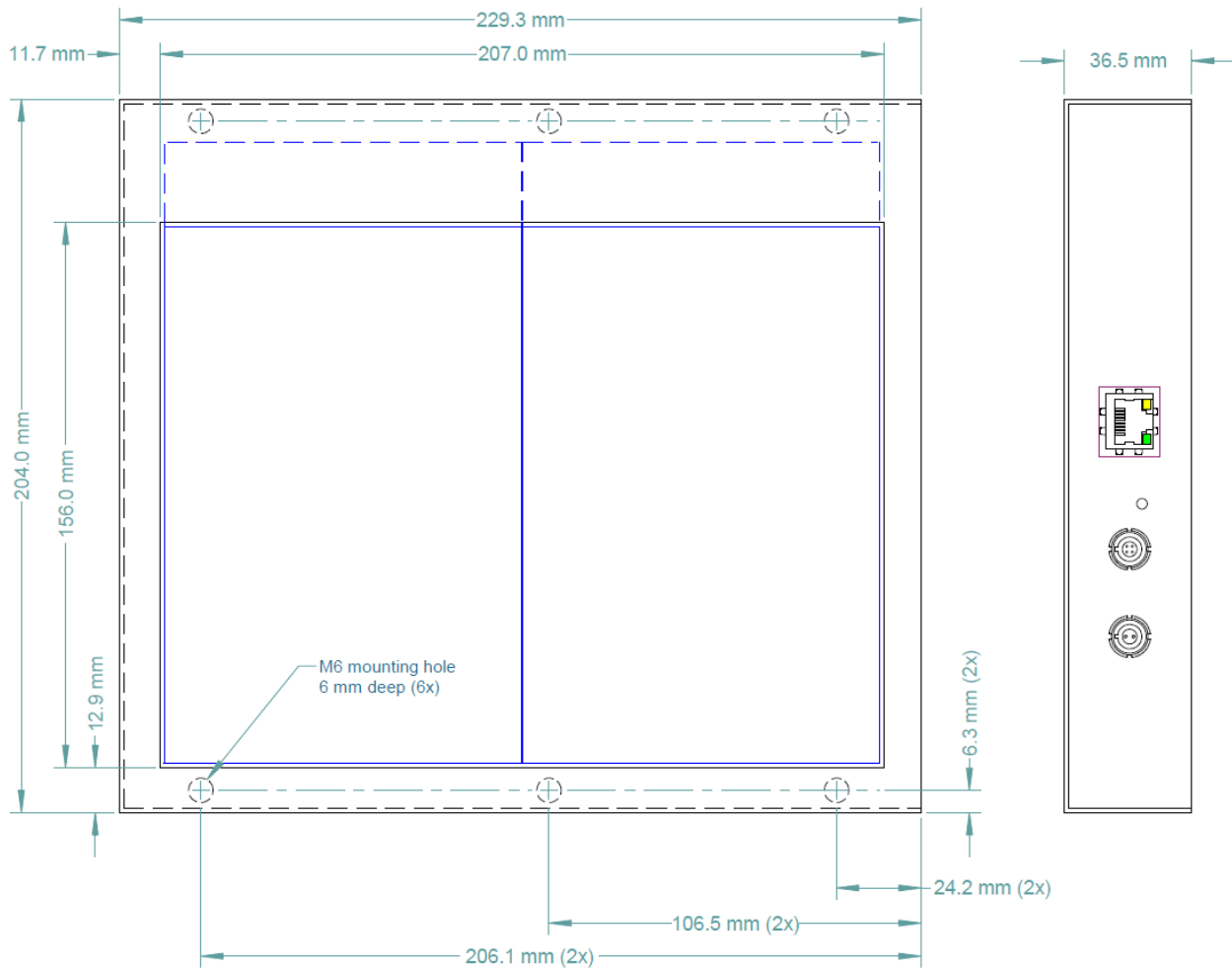

Mechanical Dimensions Rad-icon 3020HS/3030HS

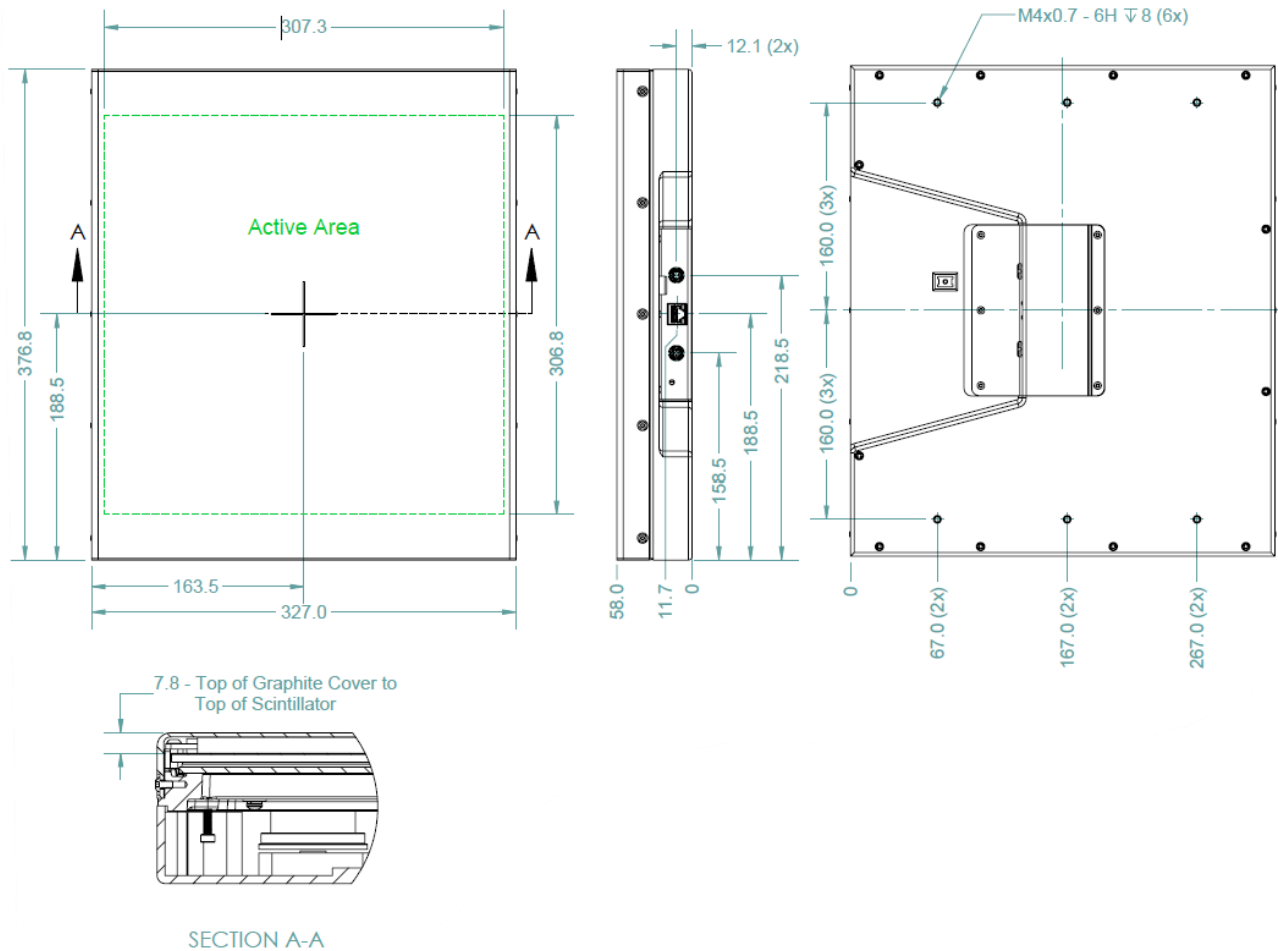

Mechanical Dimensions Rad-icon 0723/1523HS

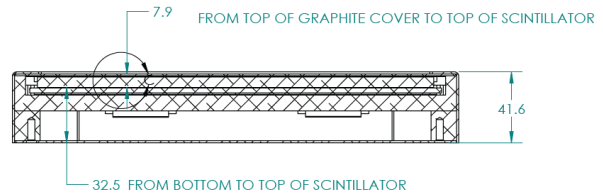
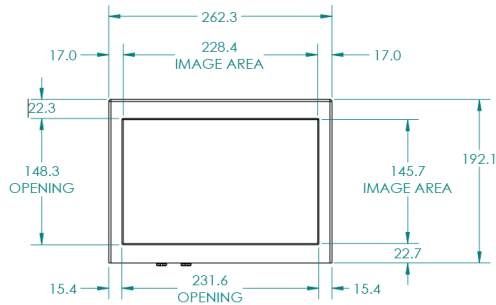

SECTION B-B
SCALE 1 : 2

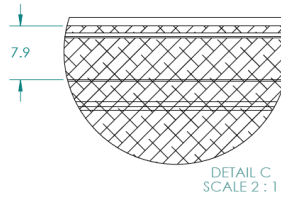
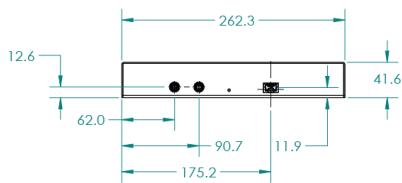

DETAIL C
SCALE 2 : 1

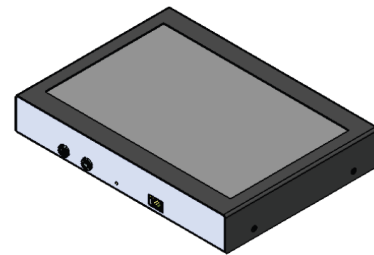
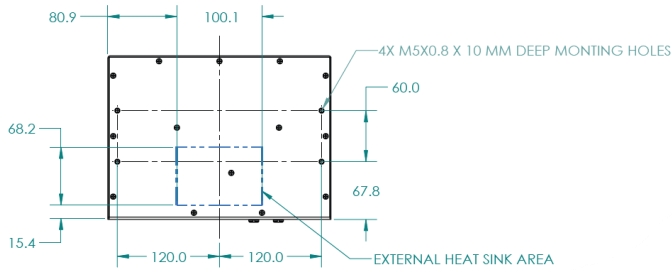

Mechanical Dimensions Rad-icon 2329HS

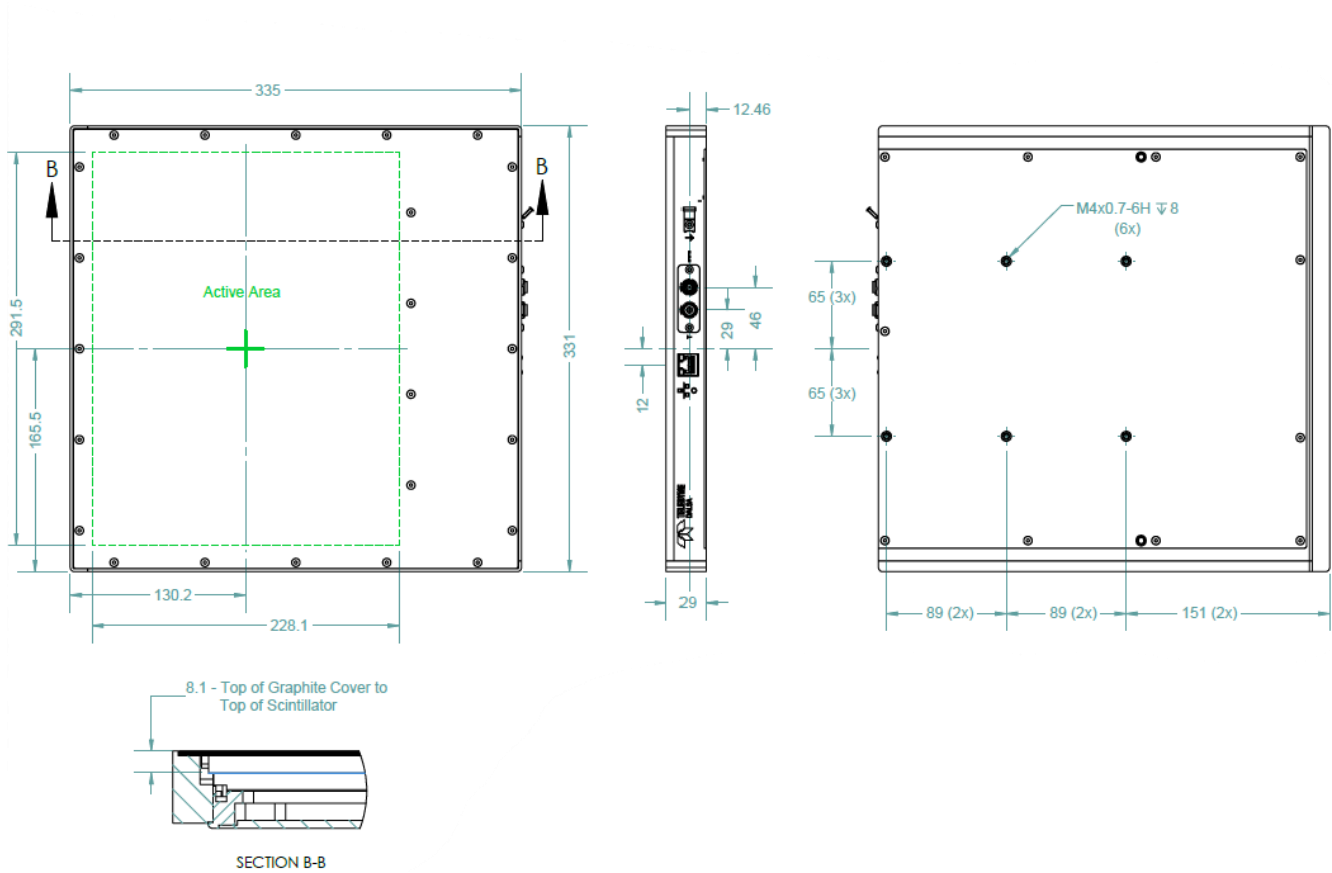

I/O Connectors

Data Connector:

RJ45: HALO HFJ11-1G16E-L12RL⁽¹⁾

CameraLink: 3M 10226-55G3PC⁽²⁾

Power Connector:

2-pin LEMO

EGG.0B.302⁽¹⁾

EGG.2B.302⁽²⁾

Pin 1 +12 VDC

Pin 2 ground



Trigger I/O Connector

4-pin LEMO EGG.0B.304⁽¹⁾/EGG.2B.304⁽²⁾

TTL (open collector), opto-isolated

Pin 1 Trig out+

Pin 2 Trig out-

Pin 3 Trig in+

Pin 4 Trig in-



⁽¹⁾ Rad-icon 0720/1520/0723HS/1523HS and 2329HS ⁽²⁾ Rad-icon 2022 and 3030 models

Ordering Information

Rad-icon detectors are available in a single, industrial image quality grade (blemish specification available on request). Specify option -010 for UHR scintillator, or option -020 for a Mitsubishi Chemical DRZ-Std (99 µm models) or option -020 for DRZ-fine (49.5 µm models) scintillator. Contact us for additional scintillator options.

All detectors ship with a universal input power supply (90-264V, 50-60Hz), power cord, Ethernet cable (if applicable) and software CD. For international orders, please specify the type of power cord you require. Please contact your Teledyne DALSA sales representative for more information.

P/N	Description
SB1739	Rad-icon 0720 (07 x 20 cm, 99 µm pixel)
SB1504	Rad-icon 1520 (15 x 20 cm, 99 µm pixel)
SB1826	Rad-icon 3020 (30 x 20 cm, 99 µm pixel)
SB1806	Rad-icon 0723HS (07 x 23 cm, 49.5 µm pixel)
SB1808	Rad-icon 1523HS (15 x 23 cm, 49.5 µm pixel)
SB1794	Rad-icon 2329HS (23 x 29 cm, 49.5 µm pixel)
SB1785	Rad-icon 3030HS (30 x 30 cm, 99 µm pixel)

Contact Information

Teledyne Rad-icon Imaging,
A BU of Teledyne Digital Imaging US, Inc.
765 Sycamore Drive, Milpitas, CA 95035
(408) 736-6000
sales.rad-icon@teledynedalsa.com
www.teledynedalsa.com/ndt

Teledyne Digital Imaging US, inc is a wholly owned subsidiary of Teledyne Technologies Inc.
Teledyne DALSA has its corporate offices in Waterloo, Canada.
Teledyne DALSA reserves the right to make changes at any time without notice. © 2025 | v1.5